

Consolidated Price List

Valves & Fittings, Hydronics, HyperPure™
Tubing, LT-CWS0616, Effective Date: June 28, 2016

Supersedes April 1, 2014 LT-WS0414 &
September 11, 2015 LH-MPL0915



VALVES &
FITTINGS



HYDRONICS

HYPERPURE™



We've got your back!™

Phone: 800-752-2082 www.legendvalve.com



Guaranteed Performance

Every order is processed in 24 hours or 5% off the order; 100% line item fill rate or 5% off the backorder; 100% line item order accuracy or 5% off the error; the Legendary 5/25 product warranty; no minimum order; no case pack quantity requirement; and material may be returned with no re-stocking fees.

Legendary Customer Service

You will always talk to a human, no voice mail or automated assistance. Trained customer service representatives to support you and your business striving to achieve 100% problem resolution in one call.

Expert Engineering

A fully-functioning and staffed laboratory for product development and design; quality assurance; and product testing assuring you and your customers the best quality products.

On Demand Technical Support

Degreed engineers, master plumbers and technical advisers with decades of PVF and hydronic experience are on demand to support your business.

Comprehensive Training

Expert staff as course instructors for distributor and contractor training classes scheduled throughout the year.



Wholesale Terms and Conditions of Sale

Terms of Payment

2% 30 Days, Net 45 - Cash discount is to be calculated on the total amount of the invoice before additions for transportation. A 1-1/2% service charge per month will be added to past due balances.

Freight Policy

Freight charges will be prepaid on orders of **\$1,500.00** net or more (see exceptions below) to one destination in the Continental United States. Otherwise, freight terms are F.O.B. Auburn Hills, Michigan or Reno, Nevada. Call Legend Customer Service at 800-752-2082 for shipments to Alaska and Hawaii.

Freight Policy

For **Cast and Ductile Iron, and Radiant Floor Panels**, freight charges will be prepaid on orders to one destination in the Continental United States as follows: orders of \$2,500.00 net or more for **Cast & Ductile Iron valves**; orders of \$2,500.00 net or more for **QuickTherm™ and VersaTherm™ radiant panels**; and orders of \$3,500.00 net or more for **HyperPure™ PE-RT Tubing 10' and 20' sticks**. All Legend products may be combined to reach either the \$2,500.00 or \$3,500.00 net. Otherwise, freight terms are F.O.B. Auburn Hills, Michigan or Reno, Nevada.

Minimum Order

Legend has no minimum order requirement.

Order Acceptance

All orders are subject to acceptance by Legend Valve & Fitting, Inc. Possession of our catalog or price list by any person should not be construed as an offer to sell to that person. All prices are subject to change without notice.

Signature Series

Private label ball valves allow you to customize the handle, including using your logo. This program is available for select ball valves. For more information, call Legend Customer Service.

Oxygen Cleaning

For most valves and fittings oxygen cleaning is available. Material is cleaned, tagged and bagged. Lead time is five business days. For more information, call Legend Customer Service.

A Legendary Guarantee

5 year / \$25 warranty. For complete details of this legendary warranty please call Legend Customer Service at 1-800-752-2082, or visit www.legendvalve.com.



No Lead Product Identification

Legend No Lead brass or bronze valves and fittings are easy to identify and order.

Legend No Lead valves and fittings comply with the Federal No Lead Law 111-380 and are third-party certified.

All No Lead brass and bronze alloy valves and fittings are highlighted in gray shading throughout this price list. Legend also adds the suffix "NL" to both the model and item number to identify the No Lead version of each product offered. Brass and bronze items not highlighted in gray are available in traditional alloy only.

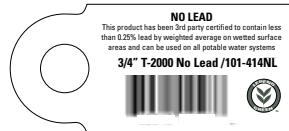

Full Port Ball Valve						
Traditional & no lead forged brass ISO-9002, 600 CWIP (1/4" - 2"), 400 CWIP (2-1/2" - 4") 150 WSP ANSI/NSF 61-G (T/S-2000NL) UPC 250psi max. CSA certified 1/2 S. 125 psig 11/4" - 4" T-2000 (1/4" - 2" T-2000NL) UL listed LP Gas (1/2" - 2" T-2000/T-2000NL) UPC/VAMPO FM approved (1/2" - 2" T-2000/T-2000NL)		101-411	1/4"	FNPT x FNPT	T-2000	7.27 120/12
		101-411NL	1/4"	FNPT x FNPT	T-2000NL	8.24 120/12
		101-412	3/8"	FNPT x FNPT	T-2000	8.76 120/12
		101-412NL	3/8"	FNPT x FNPT	T-2000NL	7.67 120/12
		101-413	1/2"	FNPT x FNPT	T-2000	9.64 100/10
		101-413NL	1/2"	FNPT x FNPT	T-2000NL	10.93 100/10
		101-414	3/4"	FNPT x FNPT	T-2000	13.96 64/8
		101-414NL	3/4"	FNPT x FNPT	T-2000NL	17.38 64/8
		101-415	1"	FNPT x FNPT	T-2000	21.19 30/6
		101-415NL	1"	FNPT x FNPT	T-2000NL	26.40 30/6
		101-416	1-1/4"	FNPT x FNPT	T-2000	36.50 24/6
		101-416NL	1-1/4"	FNPT x FNPT	T-2000NL	41.37 24/6
		101-417	1-1/2"	FNPT x FNPT	T-2000	49.79 16/4
		101-417NL	1-1/2"	FNPT x FNPT	T-2000NL	59.80 16/4
		101-418	2"	FNPT x FNPT	T-2000	70.35 4/2
		101-418NL	2"	FNPT x FNPT	T-2000NL	85.08 4/2
		101-419	2-1/2"	FNPT x FNPT	T-2000	183.15 4/2
	101-419NL	2-1/2"	FNPT x FNPT	T-2000NL	207.57 4/2	
	101-420	3"	FNPT x FNPT	T-2000	227.95 4/2	
	101-420NL	3"	FNPT x FNPT	T-2000NL	279.90 4/2	
	101-421	4"	FNPT x FNPT	T-2000	432.25 2/1	
	101-421NL	4"	FNPT x FNPT	T-2000NL	486.77 2/1	

NO LEAD IDENTIFICATION

No lead brass and bronze alloy items are highlighted in gray.

Example: If selecting a 3/4" size T-2000 ball valve, the item number 101-414 is for the traditional brass version and item number 101-414NL is for the no lead brass T-2000NL.

As many brass alloy valves and fittings have multiple uses (ie. gas, process piping, hydronics), Legend traditional brass and bronze valves and fittings for non-potable water applications are marked and identified.

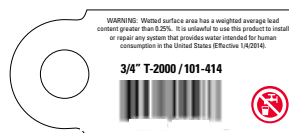

We've got your back. Visit legendvalve.com for list price sheets in PDF and Excel format, submittals, instruction manuals, tech bulletins and new product features.

TABLE OF CONTENTS

BALL VALVES

Full Port Ball Valves	10-13
T/S-1001, T/S-1001NL Ball Valves	10
T/S-1004, T/S-1004NL Pro Pattern	11
T/S-1002, T/S-1002NL Gland Follower Design	11-12
T/S-2000, T/S-2000NL Ball Valves	12-13
T/S-2001NL Waterball	13
Bronze Ball Valves	13-14
T/S-901, T/S-901NL Bronze	13-14
Specialty Ball Valves	14-18
T/S-1100, T/S-1100NL, T/S-1102, T/S-1102NL, T/S-2102NL with Drain	14-15
T-1002ST SS Ball & Stem	15
T-1002STLD SS Ball & Stem, Locking Device	15
T-1002LD Locking Device	15
T-1007 FNPT x Sweat	15
T-1001LD, T-1001LDNL Locking Device	16
T/S-1001T, T/S-1001TNL Tee Handle	16
T-1009NL Compression	16
T-2009NL Compression	16
T-2002NL Compression with Drain	16
T-2100 Three-way	17
T-1002CC with Cap & Chain	17
T-2000NL MNPT x Sweat	17
T/S-1002FLG Isolation - Flanged	17
T/S-2011RFLG Isolation - Rotating Flanged	17
P-2011 Isolation - Rotating Flanged, Press	18
T/S-2012RFLG Isolation Rotating, Purge	18
LegendPress Ball Valves	18
P-200, P-200NL Legend Press	18
Push Fit Ball Valves	18-19
P-2200NL Insta-Loc II™ No Lead	18
P-2200NL Drop Ear Push Fit Ball Valve	19
P-2200NL Insta-Loc II™ Push x FNPT	19
PEX Ball Valves	19-20
T-806NL PEX End	19
T-805NL MNPT/Sweat x PEX	19
T-2006NL PEX End	19
T-2006NL PEX with Tee Handle	19
T-2007NL PEX with Tee & Drain	20
T-2005NL PEX MNPT x PEX	20
T-2008NL PEX with Drop Ear	20

T-1960NL Cold Expansion PEX	20
T-1960NL CE PEX with Drop Ear	20
T-1960NL CE PEX MNPT x PEX	20

Mini Ball Valves	21-22
T-900, T-900NL MNPT x FNPT Large Port Lever	21
T-900T, T-900TNL MNPT x FNPT Large Tee Handle	21
T-810 Micro Ball™	21
T-800T, T-800TNL Micro Ball™	21
T-801NL Test Cocks, Screwdriver Slot	21
T-710T, T-710MxF-T Stainless Steel	22

Ball Valves Accessories	22
Lock Shields, Memory Stop, T-Handle, Lever Handle	22

Stainless Steel Ball Valves - Investment Cast	23
T-717 3-Pc 316 Stainless Steel	23
T-712 2-Pc 316 Stainless Steel	23
T-715 2-Pc 316 Stainless Steel Large Port	23
T-710 1-Pc 316 Stainless Steel Conv. Port	23

Carbon Steel Ball Valves - Investment Cast	24
T-730 2-Piece Carbon Steel	24
T-725 2-Piece Carbon Steel Large Port	24
T-720 1-Piece Carbon Steel Conv. Port	24

Gas Ball Valves	24-25
Drip Leg Kits	24
Blue Top™ Patented One-Piece Design	24-25
Red Top™ Economy Gas Ball Valves	25

For everything you need behind the wall™ see product listing by part number in the index on page 156.

GATE, CHECK, & LOW PRESSURE

Stainless Steel Gate Valves	26
T-751 316 Stainless Steel	26
Bronze Gate Valves	26-27
T-416 Rising Stem	26
T/S-414 Screw-Over Bonnet	26
T/S-415 Inserted Bonnet	26-27
T-420 Quick Opening Gate Valve	27
T-420 Brass Handle	27

Brass Gate Valves	27-29
T/S-401, T/S-401NL Brass Gate	27-28
T/S-408, T/S-408NL Economy Brass	28
T-408X Cross Handle Gate Valve	29
T/S-400, T/S-400NL Compact Pattern	29
Brass Cross Handles	29

Globe Valves	30
T/S-421, T/S-421NL Bronze Globe	30
T-422 Union Bonnet Bronze Globe	30
T-752 316 Stainless Steel Globe	30

Check Valves	30-33
T/S-451, T/S-451NL Swing Check	30-31
P-451NL Legend Press™ Swing	31
T/S-453, T/S-453NL Bronze Y-Pattern Swing Check	32
T/S-455, T/S-455NL In-Line Check	32-33
T-450NL In-Line Check	33

Stainless Steel Check Valves	34
T-750 316 Stainless Steel Check	34
T-755 304 Stainless Steel In-Line Check	34

Foot Check Valves	34
T-448NL Bronze Foot Valves	34
T-756 304 Stainless Steel Foot Valves	34

Y-Strainers	34-38
T/S-15, T/S-15NL Bronze Y-Strainers	34-35
T-16, T-16NL Compact Bronze Y-Strainer	35-36
Y-Strainer Screens	36-37
T-17 Cast Iron Y-Strainers	37

T-19 Flanged Cast Iron Y-Strainers	37
T-750 316 Stainless Steel Y-Strainers	38

Frostfree Sillcocks	38-42
T-550, T-550NL 1/4 Turn Frostfree Sillcocks, Patented Design	38
T-550 Replacement Parts	39
T-552 Close Coupled Sillcock	39
TM-550, TM-550NL Multi-turn Frostfree Sillcocks	39-40
TM-550 Replacement Parts	40
T-552, T-552NL Frostfree Sillcocks	41
T-552 Repair Parts	41
T-551, T-551 NL Standard Multi-turn	42

1/4-Turn Plumbing Valves 42-44

R-670, R-670NL Boiler Drain..... 42

R-673, R673NL, R-674, R-674NL Sillcock 42-43

R-671, R-671NL No Kink Hose Bibb..... 43

T-537, T-537NL, T-537L , T-537LNL Hose Bibb..... 43

T-540 Water Heater Drain Valve..... 43

T/S-541FLG Flanged Sillcock 43

T/S-541CFL Chrome Flanged Sillcock..... 44

T-547 RB Commercial Ball Type Sillcock..... 44

T-548 Satin Commercial Ball Type Sillcock..... 44

T-549 CP Commercial Ball Type Sillcock..... 44

Low Pressure Plumbing Valves 45

T/S-501NL, T-501X, S-501PNL Stop Valves..... 45

T/S-504, T/S-504NL, T/S-505, T/S-505NL Long Bonnet 45

T/S-503NL Angle Stop..... 45

T/S-511NL, T-512NL, S-512PNL Stop and Waste Valves..... 46

T/S-521, T/S-521NL, T-522, T-522NL, S-524, S-524NL Boiler Drains 46

T-523NL, S-521P, S-521PNL, T-206, T-206NL Boiler Drains..... 46

T-531, T-531NL, T-532, T-532NL Hose Bibbs..... 47

T-532CP, T-532CPNL Chrome Hose Bibbs 47

T-533, T-533NL, T-534, T-534NL Hose Bibbs..... 47

S-535, S-535NL Hose Bibbs..... 47

T-531HP, T-531HPNL Heavy Pattern Hose Bibbs 48

T-533HP, T-533HPNL, T-534HP, T-534HPNL, S-535HP, S-535HPNL Heavy Pattern Hose Bibbs.. 48

T-536HP, T-536HPNL Heavy Pattern Hose Bibbs 48

T/S-541, T/S-541NL,T/S-541LS, T/S-541LSNL Sillcocks..... 49

S-211, S-211NL Sillcocks..... 49

S-541P, S-541PNL Sillcocks 49

T-545, T-545NL, T-546, T-546NL Commercial Sillcocks, Chrome 49

T-545VB, T-545VBNL, T-546VB, T-546VBNL Commercial Sillcocks, Chrome 49-50

T-543, T-543NL, T-544, T-544NL Bent Nose Garden Valves 50

T-539, T-539NL Water Heater Drain Valves..... 50

Supply Stops - 1/4 Turn 50-51

INSTA-LOC™ T-595NL, T-596NL 50

T-595NL, T-595PBNL, T-593NL Angle 50-51

T-596NL, T-596PBNL, T-594NL Straight..... 51

T-597NL Dual Outlet..... 51

Supply Stops - Traditional Style..... 52-53

T/S-581NL, S-581ETNL, T/S-583NL, T/S-581LS, T/S-581LSNL Angle Valves..... 52

T/S-582NL, S-582ETNL, T-584NL Multi-Turn Straight Valves..... 53

T-587 Dual Outlet..... 53

THERMOPLASTIC VALVES

PVC Butterfly Valves..... 54

S-650, S-651 PVC Butterfly Valves..... 54

PVC Ball Valves..... 54-57

S-643 Grey PVC Flanged True Union Ball Valves 54

T/S-603 Grey PVC True Union Ball Valves 54

T/S-603V Grey PVC True Union Viton O-rings..... 55

T/S-645 Grey PVC Single Union Ball Valves..... 55

T/S-602, S-602EZ Grey PVC Compact Ball Valves 55

T/S-600, T/S-601, S-601EZ PVC Compact Ball Valves 56

S-608 ABS Compact Ball Valve - Black..... 57

PVC Check Valves..... 57

T/S-655 Grey PVC Ball Check Valves..... 57

Grey PVC Foot Valve Screens..... 57

T/S-611 PVC In-Line Check Valves..... 57

Backwater Valves..... 58

S-640, S-641, S-660, S-661 Backwater Valves..... 58

Sump Pump Swing Check Valves..... 58

S-613, S-614, S-670, S-672 Sump Pump Swing Check Valves..... 58

CPVC Ball Valves..... 59

S-605, S-606 CPVC Compact Ball Valves..... 59

S-607 Schedule 80 CPVC Ball Valves 59

Plastic Low Pressure Valves..... 59-60

CPVC, PVC, Celcon Low Pressure Valves..... 59-60

PVC & CPVC Unions..... 60-61

PVC Schedule 80, Schedule 40 Unions..... 60

CPVC Unions 60

PVC Male, PVC Spigot Adapters..... 61

CAST IRON VALVES

Cast Iron Valves 61-62

T-303 OS & Y Gate Valves 61

T-301 Non-Rising Stem Gate Valves..... 61

T-311 Swing Check Valves 61

T-19 Flanged Cast Iron Y- Strainers 62

Ductile Iron Wafer Check Valves 62

T-312 Wafer Check Valves 62

Ductile Iron Butterfly Valves 63-66

Wafer Type..... 63

T-335AB EPDM Seat - Lever Handle - 10 position 63

T-335AB-G EPDM Seat - Gear Operator 63

T-337AB Buna-N Seat - Lever Handle - 10 position 63

T-337AB-G Buna-N Seat Seat - Gear Operator 63

T-335SS - Stainless Steel Disc EPDM 64

T-337SS - Stainless Steel Disc Buna-N..... 64

Lug Type..... 64-66

T-365AB EPDM Seat - Lever Handle - 10 position 64

T-365AB-G EPDM Seat - Gear Operator 64

T-367AB Buna-N Seat - Lever Handle - 10 position 65

T-367AB-G Buna-N Seat Seat - Gear Operator 65

T-365SS - Stainless Steel Disc EPDM 65

T-367SS - Stainless Steel Disc Buna-N Seat..... 65

Gear Operator 66

SPECIALTY PRODUCTS

Backflow Valves..... 68

T/S-459 Backflow Preventers, Atmospheric Vent..... 68

T/S-457, T/S-457NL Dual Check..... 68

Vacuum Brakers..... 68

T-553, T-553NL, T-553C, T-553CNL, T-554 68

T-556 Dual Check 68

T-557, T-557C Self Draining 68

Log Lighter Valves..... 69-70

T-3500, T-3500PB Straight Pattern, Ball 69

T-3501, T-3501PB Angle Pattern, Ball..... 69

T3200, T-3200PB Straight Pattern, Globe..... 69

T-3201, T-3201PB Angle Pattern, Globe..... 69

Escutcheon and Key Accessories 69

Natural Gas Burner Bar..... 69

T-3200, T-3200PB, T-3201, T-3201PB, T-3500, T-3500PB, T-3501, T-3501PB Log Lighter Kits.. 69-70

TABLE OF CONTENTS

SPECIALTY PRODUCTS CONTINUED

Pressure Reducing Valves	70
T-6800NL PRV.....	70
T-6801NL PRV.....	70
T-6803NL PRV, Plastic Bonnet	70
T-6803NL PRV, Brass Bonnet	70
Anti-Scald Valve	71
T-41 Mixing Valve for Radiant Heating.....	71
Meter Valves	71
T-441NL, T-442NL Bronze Angle Meter Valves.....	71
T-443NL Meter Angle Ball Valve	71
Washing Machine Valves	71
T/S-11, T/S-11NL Valves	71
T-12, T-12NL Chrome plated	71
Dishwasher Elbow	72
No Lead Dishwasher Elbow.....	72
Pressure Relief Valves	72
T-50NL Pressure Relief Valve.....	72
Float Valves	72-73
T-30, T-31, T-32 Bronze Float Valves	72
Float Rods	72
Copper & Plastic Floats.....	73
Evaporative Cooler Valves	73
T-542, T-542NL	73
T-34 Standard Cooler Valve	73
T-35 Compact Cooler Valve	73
Anti-Sweat Valves	73
T-20, T-20A Anti-Sweat Valves	73
Dielectric Fittings	74-75
T-575 Dielectric Nipples.....	74
T-578 Dielectric Couplings.....	74
T-571NL Forged Steel Dielectric Unions	74
T-572 Galvanized x Galvanized Dielectric Unions.....	74
T-573NL Galvanized x Brass Dielectric Unions.....	75
T-574 Black Gas Service Dielectric Unions.....	75
Rubber Gaskets.....	75
Gaskets & Inserts For Steam	75
Compression Repair Fittings	76-77
Galvanized Compression Couplings.....	76
Brass Compression Couplings	76
PVC Compression Couplings.....	76
CPVC Compression Couplings.....	76
PVC Expansion Repair Couplings.....	77

Cast Pressure Fittings	77-80
Drop Ear Elbows.....	77-78
High Ear Elbows	78
Drain Elbows	78
Elbows.....	78
Basboard Tees.....	78
Tees.....	79
PEX Drop Ear Tee.....	79
Drain Coupling	79
Wing Adapter.....	80
PEX x CPVC Adapters	80
Unions	80
Transition Fittings	80-81
No Lead Brass x CPVC Transition Fittings.....	80
Stainless Steel x CPVC Transition Fittings.....	81
Specialty Brass Fittings	81-82
Raised Square Head Plugs.....	80
Countersunk Plugs	81
Brass Trap Connectors	82

T/S-2012RFLG Isolation Ball Valves - Rotating Flange & Purge.....	86
Tankless Water Heater Valve Kits	86-87
Pressure Relief Valves	87
T-565, T-566 Hard Seat Oil Tank Valves	87
T-60, T-60A, T-61, T-63, T-65 Chrome Steam Air Vents.....	88
T-90, T-90A, T-91, T-93, T-95 Chrome Economy Air Vent	88
T-70 Automatic Hot Water Air Vents	88
T-70H High Capacity Auto Air Vent.....	88
T-73 Automatic Air Vents.....	88
T-75 Manual Adjustable Air Vent	89
T-77 Coin Key Air Vent	89
T-80 Air Purgers.....	89
T-825 Temperature & Pressure Gauges	89-90
Carbon Steel Boiler Manifold Headers.....	90
T-570, T-570NL Mono-Flow Tees	91
T-569 Venturi Tees	91

VersaTherm and QuickTherm worksheet on page 148

Brass Fire Hose Fittings	82-83
Female x Male Brass Hydrant Adapters.....	82
Double Male Hex Nipples.....	82
Female x Male Hex Nipples.....	82
Female x Male Swivel Adapters.....	83
Caps & Plugs with Chains.....	83

HEATING VALVES

Bronze Heating & Radiator Valves	84-91
T-431, T-431YB Steam Angle Radiator Valves	84
T/S-437 Hot Water Angle Valves	84
T-435, T-435YB Radiator Gate Valves	84
T-433, T-433YB Convectator Steam Angle Valves	85
T/S-438 Union Elbows	85
S-464 Purge & Balancing Valves	85
S-439 Balancing Valves	85
T/S-425 Straight Circulator Valves	85
Radiator Valve Handles.....	85
T/S-1002FLG Isolation Ball Valves - Flanged.....	86
T/S-2011RFLG, P-2011 Isolation Ball Valves - Rotating Flange	86

RADIANT PANEL SYSTEMS

Radiant Panel Systems	94-100
VersaTherm Floor System.....	94-95
QuickTherm Floor System	96
Tubing Accessories	96-100
Snapp Rail / Clip System	100
ST-100 Staple Tool	100

LEGENDFLEX™ TUBING

LegendFlex Heating Tube	101-102
LegendFlex PEX Tubing	101-102



MANIFOLDS

Manifolds..... 104-131

- M-8000 Modular Manifolds 104-106
- M-8000 Components 107-108
- M-8100 Plastic Manifolds 109-110
- M-8100 Components 111-112
- M-8200 Precision Brass Manifolds 113-116
- Brass Manifold Accessories 116-119
- M-8220 High Capacity Manifolds..... 120-121
- M-8220 Accessories 122-123
- M-8400 Geothermal Manifolds 124-125
- M-8400 Accessories 122-123
- M-8330 Stainless Steel Manifolds..... 126-127
- M-8300E Economy Stainless Steel Manifolds 128
- M-8300EV Economy Manifold with valves..... 128
- Stainless Steel Manifold Accessories..... 129-131

HYDRONIC SYSTEM COMPONENTS

Hydronic System Components..... 132-143

- Legend Connect System 132-133
- T-88 Air & Debris Eliminator 133-135
- T-88 Accessories 137
- HS-808 Hydraulic Separator 137
- HS-808 Accessories 137
- LMV-3 Three-Way Mixing Valve..... 138
- AF-480 Auto Fill Back Flow Preventer 139
- HX-100 , HX-200, HX-300 Heat Exchangers 140
- HX-100B, HX-160B, HX-200B Compact Heat Exchangers..... 140
- LZV-2 Two Way Zone Valves..... 141
- LZV-3 Three Way Zone Valves 141
- T-825 Temperature & Pressure Gauges 142-143
- T-820 Test Gauges..... 143

AMBIANCE™ CEILING PANELS

Ceiling Panels..... 144

- Ambiance 144

CUSTOM MECHANICAL PANELS

Mechanical Panels..... 145

- Mechanical Panels..... 145

SOLAR PUMP SYSTEM

Solar Pump Systems..... 146-147

- Solar Pump System..... 146-147

FLOORING ESTIMATE SHEET

Floor System Material Estimate Worksheet..... 148

- VersaTherm and QuickTherm Worksheet 148

HYPERPURE™ TUBE

HyperPure PE-RT 150-155

- HyperPure Coils, Sticks 152-153

TOOLS & ACCESSORIES

Tools 154-155

- Accessories..... 154-55

INDEX

Index By Part Number..... 156



We've got your back. Katie, Dave & Alyssa



Legend has the most complete offering of the best quality valves and fittings for plumbing, commercial, industrial and hydronic professionals — backed by our performance and service guarantees.



FULL PORT BALL VALVES

Full Port Ball Valve

Traditional & no lead forged brass
ISO 9002, 600 CWP
400 CWP (2-1/2" - 4"), 150 WSP
NSF 61-G Listed (T/S-1001NL)
UL listed (1/4" - 2" T-1001/T-1001NL)
CSA certified 1/2, 5, 125 psig
(1/4" & 1/2"-2" T-1001/T-1001NL)
FM approved (1/2" - 2" T-1001/T-1001NL)



Part No.	Size	Configuration	Model No.	List Price	Cs/Ct
101-300	1/8"	FNPT x FNPT	T-1001	11.37	200/20
101-300NL	1/8"	FNPT x FNPT	T-1001NL	13.38	200/20
101-101	1/4"	FNPT x FNPT	T-1001	9.49	200/20
101-101NL	1/4"	FNPT x FNPT	T-1001NL	11.01	200/20
101-102	3/8"	FNPT x FNPT	T-1001	14.43	100/10
101-102NL	3/8"	FNPT x FNPT	T-1001NL	18.73	100/10
101-023	1/2"	FNPT x FNPT	T-1001	9.80	100/10
101-023NL	1/2"	FNPT x FNPT	T-1001NL	12.99	100/10
101-024	3/4"	FNPT x FNPT	T-1001	15.67	100/10
101-024NL	3/4"	FNPT x FNPT	T-1001NL	20.31	100/10
101-025	1"	FNPT x FNPT	T-1001	23.82	50/10
101-025NL	1"	FNPT x FNPT	T-1001NL	29.83	50/10
101-026	1-1/4"	FNPT x FNPT	T-1001	42.75	20/10
101-026NL	1-1/4"	FNPT x FNPT	T-1001NL	51.50	20/10
101-027	1-1/2"	FNPT x FNPT	T-1001	52.34	20/4
101-027NL	1-1/2"	FNPT x FNPT	T-1001NL	68.40	20/4
101-028	2"	FNPT x FNPT	T-1001	82.65	20/4
101-028NL	2"	FNPT x FNPT	T-1001NL	103.75	20/4
101-109	2-1/2"	FNPT x FNPT	T-1001	294.44	6/2
101-109NL	2-1/2"	FNPT x FNPT	T-1001NL	315.81	6/2
101-110	3"	FNPT x FNPT	T-1001	388.61	4/2
101-110NL	3"	FNPT x FNPT	T-1001NL	432.45	4/2
101-111	4"	FNPT x FNPT	T-1001	823.22	2/1
101-111NL	4"	FNPT x FNPT	T-1001NL	846.36	2/1



101-043	1/2"	Sweat x Sweat	S-1001	9.80	100/10
101-043NL	1/2"	Sweat x Sweat	S-1001NL	12.99	100/10
101-044	3/4"	Sweat x Sweat	S-1001	15.67	60/10
101-044NL	3/4"	Sweat x Sweat	S-1001NL	20.31	60/10
101-045	1"	Sweat x Sweat	S-1001	23.82	36/6
101-045NL	1"	Sweat x Sweat	S-1001NL	29.83	36/6
101-046	1-1/4"	Sweat x Sweat	S-1001	42.75	24/4
101-046NL	1-1/4"	Sweat x Sweat	S-1001NL	51.50	24/4
101-047	1-1/2"	Sweat x Sweat	S-1001	52.34	16/4
101-047NL	1-1/2"	Sweat x Sweat	S-1001NL	68.40	16/4
101-048	2"	Sweat x Sweat	S-1001	82.65	10/2
101-048NL	2"	Sweat x Sweat	S-1001NL	101.56	10/2
101-209	2-1/2"	Sweat x Sweat	S-1001	294.44	6/2
101-209NL	2-1/2"	Sweat x Sweat	S-1001NL	315.81	6/2
101-210	3"	Sweat x Sweat	S-1001	388.61	4/2
101-210NL	3"	Sweat x Sweat	S-1001NL	432.45	4/2
101-211	4"	Sweat x Sweat	S-1001	823.22	4/1

4" S-1001 is conventional port.



FULL PORT BALL VALVES

Full Port Ball Valve, Pro Pattern	Part No.	Size	Configuration	Model No.	List Price	Cs/Ct	
Traditional & no lead forged brass ISO 9002, 600 CWP, 150 WSP ANSI/NSF 61-G Listed (T/S-1004NL) CSA certified 1/2, 5, 125 psig (1/2"-2" T-1004) 5, 125 psig (1/2"-2" T-1004NL) UL listed (1/2" - 2" T-1004) FM approved (1/2" - 2" T-1004 / T-1004NL)	101-013	1/2"	FNPT x FNPT	T-1004	13.69	100/10	
	101-013NL	1/2"	FNPT x FNPT	T-1004NL	18.22	100/10	
	101-014	3/4"	FNPT x FNPT	T-1004	19.90	100/10	
	101-014NL	3/4"	FNPT x FNPT	T-1004NL	25.79	100/10	
	101-015	1"	FNPT x FNPT	T-1004	34.37	50/10	
	101-015NL	1"	FNPT x FNPT	T-1004NL	41.00	50/10	
	101-016	1-1/4"	FNPT x FNPT	T-1004	61.10	20/10	
	101-016NL	1-1/4"	FNPT x FNPT	T-1004NL	74.00	20/10	
	101-017	1-1/2"	FNPT x FNPT	T-1004	77.26	20/4	
	101-017NL	1-1/2"	FNPT x FNPT	T-1004NL	92.21	20/4	
	101-018	2"	FNPT x FNPT	T-1004	111.94	20/4	
	101-018NL	2"	FNPT x FNPT	T-1004NL	139.43	20/4	
	101-019	2-1/2"	FNPT x FNPT	T-1004	424.35	6/2	
	101-020	3"	FNPT x FNPT	T-1004	602.88	4/2	
	101-021	4"	FNPT x FNPT	T-1004	1010.09	2/1	
	Traditional & no lead forged brass ISO 9002, 600 CWP, 150 WSP ANSI/NSF 61-G Listed (T/S-1002NL) CSA certified 1/2, 5, 125 psig (1/2"-2" T-1002/T-1002NL) UL listed (1/2" - 2" T-1002) FM approved (1/2" - 2" T-1002) Third party certified Truesdail	101-033	1/2"	Sweat x Sweat	S-1004	13.69	100/10
		101-033NL	1/2"	Sweat x Sweat	S-1004NL	18.22	100/10
		101-034	3/4"	Sweat x Sweat	S-1004	19.90	100/10
		101-034NL	3/4"	Sweat x Sweat	S-1004NL	25.79	100/10
		101-035	1"	Sweat x Sweat	S-1004	34.37	50/10
		101-035NL	1"	Sweat x Sweat	S-1004NL	41.00	50/10
101-036		1-1/4"	Sweat x Sweat	S-1004	61.10	20/10	
101-036NL		1-1/4"	Sweat x Sweat	S-1004NL	74.00	20/10	
101-037		1-1/2"	Sweat x Sweat	S-1004	77.26	20/4	
101-037NL		1-1/2"	Sweat x Sweat	S-1004NL	92.21	20/4	
101-038		2"	Sweat x Sweat	S-1004	111.94	4/2	
101-038NL		2"	Sweat x Sweat	S-1004NL	139.43	4/2	
101-039		2-1/2"	Sweat x Sweat	S-1004	424.35	6/2	
101-040		3"	Sweat x Sweat	S-1004	602.88	4/2	



Cubic Ball

T-1004



Cubic Ball

S-1004

Full Port Ball Valve, Gland Follower Design

Traditional & no lead forged brass
 ISO-9002, 600 CWP, 150 WSP
 ANSI/NSF 61-G (T/S-1002NL)
 CSA certified 1/2, 5, 125 psig
 (1/2"-2" T-1002/T-1002NL)
 UL listed (1/2" - 2" T-1002)
 FM approved (1/2" - 2" T-1002)
 Third party certified Truesdail



T-1002

101-061	1/4"	FNPT x FNPT	T-1002	10.44	180/10
101-061NL	1/4"	FNPT x FNPT	T-1002NL	12.41	180/10
101-062	3/8"	FNPT x FNPT	T-1002	10.44	180/10
101-062NL	3/8"	FNPT x FNPT	T-1002NL	12.41	180/10
101-063	1/2"	FNPT x FNPT	T-1002	9.12	120/10
101-063NL	1/2"	FNPT x FNPT	T-1002NL	11.27	120/10
101-064	3/4"	FNPT x FNPT	T-1002	15.47	90/10
101-064NL	3/4"	FNPT x FNPT	T-1002NL	19.61	90/10
101-065	1"	FNPT x FNPT	T-1002	24.09	60/6
101-065NL	1"	FNPT x FNPT	T-1002NL	29.76	60/6
101-066	1-1/4"	FNPT x FNPT	T-1002	42.73	36/4
101-066NL	1-1/4"	FNPT x FNPT	T-1002NL	52.79	36/4
101-067	1-1/2"	FNPT x FNPT	T-1002	56.78	24/4
101-067NL	1-1/2"	FNPT x FNPT	T-1002NL	70.15	24/4

FULL PORT BALL VALVES

Full Port Ball Valve, Gland Follower Design (cont.)

Traditional & no lead forged brass
ISO-9002, 600 CWP, 150 WSP
ANSI/NSF 61-G (T/S-1002NL)
CSA certified 1/2, 5, 125 psig
(1/2"-2" T-1002/T-1002NL)
UL listed (1/2" - 2" T-1002)
FM approved (1/2" - 2" T-1002)



Part No.	Size	Configuration	Model No.	List Price	Cs/Ct
101-068	2"	FNPT x FNPT	T-1002	80.24	12/2
101-068NL	2"	FNPT x FNPT	T-1002NL	99.12	12/2
101-069	2-1/2"	FNPT x FNPT	T-1002	286.40	8/2
101-069NL	2-1/2"	FNPT x FNPT	T-1002NL	323.24	8/2
101-070	3"	FNPT x FNPT	T-1002	371.73	6/2
101-070NL	3"	FNPT x FNPT	T-1002NL	479.19	6/2
101-082	3/8"	Sweat x Sweat	S-1002	10.44	180/10
101-082NL	3/8"	Sweat x Sweat	S-1002NL	12.41	180/10
101-083	1/2"	Sweat x Sweat	S-1002	9.12	120/10
101-083NL	1/2"	Sweat x Sweat	S-1002NL	11.27	120/10
101-084	3/4"	Sweat x Sweat	S-1002	15.47	90/10
101-084NL	3/4"	Sweat x Sweat	S-1002NL	19.61	90/10
101-085	1"	Sweat x Sweat	S-1002	24.09	60/6
101-085NL	1"	Sweat x Sweat	S-1002NL	29.76	60/6
101-086	1-1/4"	Sweat x Sweat	S-1002	42.73	36/4
101-086NL	1-1/4"	Sweat x Sweat	S-1002NL	52.79	36/4
101-087	1-1/2"	Sweat x Sweat	S-1002	56.78	24/4
101-087NL	1-1/2"	Sweat x Sweat	S-1002NL	70.15	24/4
101-088	2"	Sweat x Sweat	S-1002	80.24	12/2
101-088NL	2"	Sweat x Sweat	S-1002NL	99.12	12/2
101-089	2-1/2"	Sweat x Sweat	S-1002	286.40	8/2
101-089NL	2-1/2"	Sweat x Sweat	S-1002NL	323.24	8/2
101-090	3"	Sweat x Sweat	S-1002	371.73	6/2
101-090NL	3"	Sweat x Sweat	S-1002NL	479.19	6/2

Full Port Ball Valve

Traditional & no lead forged brass
ISO-9002, 600 CWP (1/4" - 2"), 400 CWP (2-1/2" - 4")
150 WSP
ANSI/NSF 61-G (T/S-2000NL) UPC 250 psi max.
CSA certified 1/2, 5, 125 psig
(1/4"- 4" T-2000)(1/4"- 2" T-2000NL)
UL listed LP Gas (1/2" - 2" T-2000/T-2000NL)
UPC/IAMPO
FM approved (1/2" - 2" T-2000/T-2000NL)
Third party certified Truesdail



101-411	1/4"	FNPT x FNPT	T-2000	7.27	120/12
101-411NL	1/4"	FNPT x FNPT	T-2000NL	8.24	120/12
101-412	3/8"	FNPT x FNPT	T-2000	6.76	120/12
101-412NL	3/8"	FNPT x FNPT	T-2000NL	7.67	120/12
101-413	1/2"	FNPT x FNPT	T-2000	9.64	100/10
101-413NL	1/2"	FNPT x FNPT	T-2000NL	10.93	100/10
101-414	3/4"	FNPT x FNPT	T-2000	13.96	64/8
101-414NL	3/4"	FNPT x FNPT	T-2000NL	17.38	64/8
101-415	1"	FNPT x FNPT	T-2000	21.19	30/6
101-415NL	1"	FNPT x FNPT	T-2000NL	28.40	30/6
101-416	1-1/4"	FNPT x FNPT	T-2000	36.50	24/6
101-416NL	1-1/4"	FNPT x FNPT	T-2000NL	41.37	24/6
101-417	1-1/2"	FNPT x FNPT	T-2000	49.79	16/4
101-417NL	1-1/2"	FNPT x FNPT	T-2000NL	59.80	16/4
101-418	2"	FNPT x FNPT	T-2000	70.35	4/2
101-418NL	2"	FNPT x FNPT	T-2000NL	85.08	4/2
101-419	2-1/2"	FNPT x FNPT	T-2000	183.15	4/2
101-419NL	2-1/2"	FNPT x FNPT	T-2000NL	207.57	4/2
101-420	3"	FNPT x FNPT	T-2000	227.95	4/2
101-420NL	3"	FNPT x FNPT	T-2000NL	279.90	4/2
101-421	4"	FNPT x FNPT	T-2000	432.25	2/1
101-421NL	4"	FNPT x FNPT	T-2000NL	486.77	2/1



FULL PORT BALL VALVES

Full Port Ball Valve (cont.)

Traditional & no lead forged brass
ISO-9002, 600 CWP (1/4" - 2"), 400 CWP (2-1/2" - 4")
150 WSP
ANSI/NSF 61-G (T/S-2000NL) UPC / IAPMO
CSA certified 1/2, 5, 125 psig
(1/4" - 4" T-2000) (1/4" - 2" T-2000NL)
UL listed LP Gas (1/2" - 2" T-2000/T-2000NL)
FM approved (1/2" - 2" T-2000/T-2000NL)
UL listed T/S 2000 only
Third party certified Truesdail



S-2000NL

Part No.	Size	Configuration	Model No.	List Price	Cs/Ct
101-423	1/2"	Sweat x Sweat	S-2000	9.64	100/10
101-423NL	1/2"	Sweat x Sweat	S-2000NL	10.93	100/10
101-424	3/4"	Sweat x Sweat	S-2000	13.96	64/8
101-424NL	3/4"	Sweat x Sweat	S-2000NL	17.38	64/8
101-425	1"	Sweat x Sweat	S-2000	21.19	30/6
101-425NL	1"	Sweat x Sweat	S-2000NL	28.40	30/6
101-426	1-1/4"	Sweat x Sweat	S-2000	36.50	24/6
101-426NL	1-1/4"	Sweat x Sweat	S-2000NL	41.37	24/6
101-427	1-1/2"	Sweat x Sweat	S-2000	49.79	16/4
101-427NL	1-1/2"	Sweat x Sweat	S-2000NL	59.80	16/4
101-428	2"	Sweat x Sweat	S-2000	70.35	8/2
101-428NL	2"	Sweat x Sweat	S-2000NL	85.08	8/2
101-429	2-1/2"	Sweat x Sweat	S-2000	183.15	4/2
101-429NL	2-1/2"	Sweat x Sweat	S-2000NL	207.57	4/2
101-430	3"	Sweat x Sweat	S-2000	227.95	4/2
101-430NL	3"	Sweat x Sweat	S-2000NL	279.90	4/2
101-431	4"	Sweat x Sweat	S-2000	432.25	2/1
101-431NL	4"	Sweat x Sweat	S-2000NL	486.77	2/1

Waterball™ Full Port Ball Valve

No lead & DZR forged brass
600 CWP,
ANSI/NSF 61-G
Third party certified IAPMO



T-2001NL

101-323NL	1/2"	FNPT x FNPT	T-2001NL	9.79	100/10
101-324NL	3/4"	FNPT x FNPT	T-2001NL	14.56	64/8
101-325NL	1"	FNPT x FNPT	T-2001NL	23.78	30/6
101-326NL	1-1/4"	FNPT x FNPT	T-2001NL	37.02	24/6
101-327NL	1-1/2"	FNPT x FNPT	T-2001NL	48.43	16/4
101-328NL	2"	FNPT x FNPT	T-2001NL	83.88	8/2



S-2001NL

101-333NL	1/2"	Sweat x Sweat	S-2001NL	9.79	100/10
101-334NL	3/4"	Sweat x Sweat	S-2001NL	14.56	64/8
101-335NL	1"	Sweat x Sweat	S-2001NL	23.78	30/6
101-336NL	1-1/4"	Sweat x Sweat	S-2001NL	37.02	24/6
101-337NL	1-1/2"	Sweat x Sweat	S-2001NL	48.43	16/4
101-338NL	2"	Sweat x Sweat	S-2001NL	83.88	8/2

BRONZE BALL VALVES

Bronze Full Port Ball Valve

ISO 9002, 600 CWP, 150 WSP
ANSI/NSF 61-G (T/S-901NL)
Third party certified Truesdail



T-901

101-221	1/4"	FNPT x FNPT	T-901	19.00	180/10
101-221NL	1/4"	FNPT x FNPT	T-901NL	18.36	180/10
101-222	3/8"	FNPT x FNPT	T-901	19.00	180/10
101-222NL	3/8"	FNPT x FNPT	T-901NL	18.36	180/10
101-223	1/2"	FNPT x FNPT	T-901	17.99	120/10
101-223NL	1/2"	FNPT x FNPT	T-901NL	18.69	120/10
101-224	3/4"	FNPT x FNPT	T-901	29.99	90/10
101-224NL	3/4"	FNPT x FNPT	T-901NL	31.88	90/10
101-225	1"	FNPT x FNPT	T-901	46.00	60/6
101-225NL	1"	FNPT x FNPT	T-901NL	48.23	60/6

BRONZE BALL VALVES

Bronze Full Port Ball Valve (cont.)

ISO 9002, 600 CWP, 150 WSP
ANSI/NSF 61-G (T/S-901NL)
Third party certified Truesdail



T-901



S-901

Part No.	Size	Configuration	Model No.	List Price	Cs/Ct
101-226	1-1/4"	FNPT x FNPT	T-901	79.29	36/4
101-226NL	1-1/4"	FNPT x FNPT	T-901NL	81.70	36/4
101-227	1-1/2"	FNPT x FNPT	T-901	98.90	24/4
101-227NL	1-1/2"	FNPT x FNPT	T-901NL	108.17	24/4
101-228	2"	FNPT x FNPT	T-901	146.66	12/2
101-228NL	2"	FNPT x FNPT	T-901NL	175.00	12/2
101-229	2-1/2"	FNPT x FNPT	T-901	407.30	8/2
101-230	3"	FNPT x FNPT	T-901	645.00	6/2
101-233	1/2"	Sweat x Sweat	S-901	17.99	120/10
101-233NL	1/2"	Sweat x Sweat	S-901NL	18.69	120/10
101-234	3/4"	Sweat x Sweat	S-901	29.99	90/10
101-234NL	3/4"	Sweat x Sweat	S-901NL	31.88	90/10
101-235	1"	Sweat x Sweat	S-901	46.00	60/6
101-235NL	1"	Sweat x Sweat	S-901NL	48.23	60/6
101-236	1-1/4"	Sweat x Sweat	S-901	79.29	36/4
101-236NL	1-1/4"	Sweat x Sweat	S-901NL	81.70	36/4
101-237	1-1/2"	Sweat x Sweat	S-901	98.90	24/4
101-237NL	1-1/2"	Sweat x Sweat	S-901NL	108.17	24/4
101-238	2"	Sweat x Sweat	S-901	146.66	12/2
101-238NL	2"	Sweat x Sweat	S-901NL	175.00	12/2

SPECIALTY BALL VALVES

Full Port Ball Valve With Drain

Traditional & no lead forged brass
ISO 9002, 500 CWP
NSF 61-G (NL only)



T-1100



S-1100

101-503	1/2"	FNPT x FNPT	T-1100	20.66	100/10
101-503NL	1/2"	FNPT x FNPT	T-1100NL	23.61	100/10
101-504	3/4"	FNPT x FNPT	T-1100	32.00	60/10
101-504NL	3/4"	FNPT x FNPT	T-1100NL	35.48	60/10
101-505	1"	FNPT x FNPT	T-1100	42.00	36/6
101-505NL	1"	FNPT x FNPT	T-1100NL	46.26	36/6
101-513	1/2"	Sweat x Sweat	S-1100	20.66	100/10
101-513NL	1/2"	Sweat x Sweat	S-1100NL	23.61	100/10
101-514	3/4"	Sweat x Sweat	S-1100	32.00	60/10
101-514NL	3/4"	Sweat x Sweat	S-1100NL	35.48	60/10
101-515	1"	Sweat x Sweat	S-1100	42.00	36/6
101-515NL	1"	Sweat x Sweat	S-1100NL	46.26	36/6
101-606NL	1/2"	FNPT x FNPT	T-1102NL	15.53	120/10
101-607NL	3/4"	FNPT x FNPT	T-1102NL	26.57	60/10
101-608NL	1"	FNPT x FNPT	T-1102NL	38.42	36/6
101-603NL	1/2"	Sweat x Sweat	S-1102NL	15.53	120/10
101-604NL	3/4"	Sweat x Sweat	S-1102NL	26.57	60/10
101-605NL	1"	Sweat x Sweat	S-1102NL	38.42	36/6

Third party certified Truesdail



T-1102

S-1102



SPECIALTY BALL VALVES

Full Port Ball Valve With Drain (cont.)

No lead & DZR forged brass
ISO 9002, 600 CWP
NSF 61-G



	Part No.	Size	Configuration	Model No.	List Price	Cs/Ct
NEW	101-703NL	1/2"	FNPT x FNPT	T-2102NL	14.14	120/10
NEW	101-704NL	3/4"	FNPT x FNPT	T-2102NL	18.53	60/10
NEW	101-705NL	1"	FNPT x FNPT	T-2102NL	28.50	36/6
NEW	101-706NL	1/2"	Sweat x Sweat	S-2102NL	14.14	120/10
NEW	101-707NL	3/4"	Sweat x Sweat	S-2102NL	18.53	60/10
NEW	101-708NL	1"	Sweat x Sweat	S-2102NL	28.50	36/6

Full Port Ball Valve, SS Ball & Stem

Traditional forged brass
ISO 9002, 600 CWP, 150 WSP
CSA certified, UL listed, FM approved



T-1002ST

	101-723	1/2"	FNPT x FNPT	T-1002ST	30.72	120/10
	101-724	3/4"	FNPT x FNPT	T-1002ST	49.80	90/10
	101-725	1"	FNPT x FNPT	T-1002ST	66.33	60/6
	101-726	1-1/4"	FNPT x FNPT	T-1002ST	102.92	36/4
	101-727	1-1/2"	FNPT x FNPT	T-1002ST	125.60	24/4
	101-728	2"	FNPT x FNPT	T-1002ST	241.47	12/2

304 Stainless Steel Ball & Stem. Stainless steel handle sold separately.

Full Port Ball Valve, SS Ball & Stem w / LD

Traditional forged brass
ISO 9002, 600 CWP, 150 WSP
CSA certified, UL listed
FM approved



T-1002STLD

	101-733	1/2"	FNPT x FNPT	T-1002STLD	29.99	120/10
	101-734	3/4"	FNPT x FNPT	T-1002STLD	56.23	90/10
	101-735	1"	FNPT x FNPT	T-1002STLD	69.99	90/10
	101-736	1-1/4"	FNPT x FNPT	T-1002STLD	112.63	60/6
	101-737	1-1/2"	FNPT x FNPT	T-1002STLD	148.00	36/4
	101-738	2"	FNPT x FNPT	T-1002STLD	287.16	12/2

304 Stainless Steel Ball & Stem with locking device.

Full Port Ball Valve, Locking Device

Traditional forged brass
ISO 9002, 600 CWP, 150 WSP
CSA certified, UL listed (1/2" - 2")
FM approved (1/2" - 2")



T-1002LD



	101-611	1/4"	FNPT x FNPT	T-1002LD	17.49	180/10
	101-612	3/8"	FNPT x FNPT	T-1002LD	17.49	180/10
	101-613	1/2"	FNPT x FNPT	T-1002LD	17.49	120/10
	101-614	3/4"	FNPT x FNPT	T-1002LD	27.55	90/10
	101-615	1"	FNPT x FNPT	T-1002LD	36.39	60/6
	101-616	1-1/4"	FNPT x FNPT	T-1002LD	61.10	36/4
	101-617	1-1/2"	FNPT x FNPT	T-1002LD	75.60	24/4
	101-618	2"	FNPT x FNPT	T-1002LD	117.32	12/2

FNPT x Sweat Full Port Ball Valve

Traditional forged brass
ISO 9002, 600 CWP, 150 WSP



T-1007

For Connecting Boilers to Copper Tube

	101-623	1/2"	FNPT x Sweat	T-1007	13.03	120/10
	101-624	3/4"	FNPT x Sweat	T-1007	21.79	90/10
	101-625	1"	FNPT x Sweat	T-1007	33.72	60/6

SPECIALTY BALL VALVES

Full Port Ball Valve, Locking Device

Traditional & no lead forged brass
ISO 9002, 600 CWP (1/2" - 2"), 400 CWP (2-1/2" - 4")
150 WSP
NSF 61-G Listed (T/S-1001NL)
UL listed (1/4" - 2" T-1001/T-1001NL)
CSA certified 1/2, 5, 125 psig
(1/4" & 1/2"-2" T-1001/T-1001NL)
FM approved (1/2" - 2" T-1001/T-1001NL)



T-1001LD



Part No.	Size	Configuration	Model No.	List Price	Cs/Ct
101-053	1/2"	FNPT x FNPT	T-1001LD	16.99	100/10
101-053NL	1/2"	FNPT x FNPT	T-1001LDNL	19.88	100/10
101-054	3/4"	FNPT x FNPT	T-1001LD	26.28	100/10
101-054NL	3/4"	FNPT x FNPT	T-1001LDNL	29.67	100/10
101-055	1"	FNPT x FNPT	T-1001LD	37.13	50/10
101-055NL	1"	FNPT x FNPT	T-1001LDNL	43.42	50/10
101-056	1-1/4"	FNPT x FNPT	T-1001LD	55.89	20/10
101-056NL	1-1/4"	FNPT x FNPT	T-1001LDNL	65.36	20/10
101-057	1-1/2"	FNPT x FNPT	T-1001LD	71.04	20/4
101-057NL	1-1/2"	FNPT x FNPT	T-1001LDNL	82.21	20/4
101-058	2"	FNPT x FNPT	T-1001LD	104.92	20/4
101-058NL	2"	FNPT x FNPT	T-1001LDNL	120.20	20/4

Full Port Ball Valve with T-Handle

Traditional & no lead forged brass
ISO 9002, 600 CWP, 150 WSP
NSF 61-G Listed (T/S-1001NL)
UL listed (1/4" - 2" T-1001/T-1001NL)
CSA certified 1/2, 5, 125 psig
(1/4" & 1/2"-2" T-1001/T-1001NL)
FM approved
(1/2" - 2" T-1001/T-1001NL)



T-1001T



S-1001T

101-653	1/2"	FNPT x FNPT	T-1001T	10.53	100/10
101-653NL	1/2"	FNPT x FNPT	T-1001TNL	14.91	100/10
101-654	3/4"	FNPT x FNPT	T-1001T	17.09	60/10
101-654NL	3/4"	FNPT x FNPT	T-1001TNL	20.86	60/10
101-655	1"	FNPT x FNPT	T-1001T	27.28	50/5
101-655NL	1"	FNPT x FNPT	T-1001TNL	29.55	50/5
101-633	1/2"	Sweat x Sweat	S-1001T	10.53	100/10
101-633NL	1/2"	Sweat x Sweat	S-1001TNL	14.91	100/10
101-634	3/4"	Sweat x Sweat	S-1001T	17.09	60/10
101-634NL	3/4"	Sweat x Sweat	S-1001TNL	20.86	60/10
101-635	1"	Sweat x Sweat	S-1001T	27.28	36/6
101-635NL	1"	Sweat x Sweat	S-1001TNL	29.55	36/6

No Lead Full Port Ball Valve, Compression

No lead forged brass
ISO 9002, 600 CWP
ANSI/NSF 61-G



T-1009NL

No lead DZR forged brass
ISO 9002, 600 CWP
ANSI/NSF 61-G
UPC/IAPMO, 150 WSP



T-2009NL

No lead DZR forged brass
ISO 9002, 600 CWP
ANSI/NSF 61-G
UPC/IAPMO





T-2002NL
With Drain



101-643NL	1/2"	Comp x Comp	T-1009NL	32.75	100/10
101-644NL	3/4"	Comp x Comp	T-1009NL	39.08	60/10
101-645NL	1"	Comp x Comp	T-1009NL	68.37	36/6
101-453NL	1/2"	Comp x Comp	T-2009NL	16.99	96/12
101-454NL	3/4"	Comp x Comp	T-2009NL	29.85	64/8
101-455NL	1"	Comp x Comp	T-2009NL	45.01	36/6
With Drain					
101-433NL	1/2"	Comp x Comp	T-2002NL	17.06	80/10
101-434NL	3/4"	Comp x Comp	T-2002NL	27.56	48/6
101-435NL	1"	Comp x Comp	T-2002NL	44.83	24/12









SPECIALTY BALL VALVES

Full Port Three-Way Ball Valve	Part No.	Size	Configuration	Model No.	List Price	Cs/Ct
Forged brass ISO 9002, 600 CWP, 150 WSP L-port style  T-2100	101-441	1/4"	FNPT x FNPT	T-2100	11.99	100/10
	101-442	3/8"	FNPT x FNPT	T-2100	12.69	100/10
	101-443	1/2"	FNPT x FNPT	T-2100	17.19	60/6
	101-444	3/4"	FNPT x FNPT	T-2100	27.81	48/6
	101-445	1"	FNPT x FNPT	T-2100	42.36	24/6
	101-446	1-1/4"	FNPT x FNPT	T-2100	93.33	24/6
	101-447	1-1/2"	FNPT x FNPT	T-2100	158.22	24/6
	101-448	2"	FNPT x FNPT	T-2100	244.66	24/6

Full Port Ball Valve with Cap & Chain	Part No.	Size	Configuration	Model No.	List Price	Cs/Ct
Forged brass ISO 9002, 600 CWP  T-1002CC	101-570	3/4"	FNPT x MGHT	T-1002CC	30.77	50/10

T-2000 MxSNL Full Port Ball Valve	Part No.	Size	Configuration	Model No.	List Price	Cs/Ct
No lead DZR forged brass 600 CWP, 150 WSP ANSI/NSF 61-G Third party certified IAPMO   T-2000MxSNL	NEW 101-684NL	3/4"	MNPT x Sweat	T-2000MxSNL	17.36	64/8

Isolation Ball Valve - Flanged	Part No.	Size	Configuration	Model No.	List Price	Cs/Ct
Forged brass ISO 9002, 600 CWP, 150 WSP Bolt set included   T-1002FLG  S-1002FLG	101-074	3/4"	FNPT x Flange	T-1002FLG	34.28	36/6
	101-075	1"	FNPT x Flange	T-1002FLG	36.96	32/4
	101-076	1-1/4"	FNPT x Flange	T-1002FLG	46.88	24/4
	101-094	3/4"	Sweat x Flange	S-1002FLG	34.28	36/6
	101-095	1"	Sweat x Flange	S-1002FLG	36.96	32/4
	101-096	1-1/4"	Sweat x Flange	S-1002FLG	46.88	24/4

Isolation Ball Valve - Rotating Flange	Part No.	Size	Configuration	Model No.	List Price	Cs/Ct
Forged brass ISO 9002, 600 CWP Bolt set included   T-2011RFLG  S-2011RFLG	101-274	3/4"	FNPT x Flange	T-2011RFLG	39.99	24/1
	101-275	1"	FNPT x Flange	T-2011RFLG	46.11	18/1
	101-276	1-1/4"	FNPT x Flange	T-2011RFLG	58.56	12/1
	101-294	3/4"	Sweat x Flange	S-2011RFLG	39.99	24/1
	101-295	1"	Sweat x Flange	S-2011RFLG	46.11	18/1
	101-296	1-1/4"	Sweat x Flange	S-2011RFLG	58.56	12/1

Rotating flange for greater installation ease

SPECIALTY BALL VALVES

Isolation Ball Valve - Rotating Flange

Forged brass
ISO 9002, 600 CWP
Bolt set included



P-2011

NEW
NEW
NEW

Part No.	Size	Configuration	Model No.	List Price	Cs/Ct
Rotating Flange LegendPress™					
101-284	3/4"	Press x Flange	P-2011	44.43	24/1
101-285	1"	Press x Flange	P-2011	51.23	18/1
101-286	1-1/4"	Press x Flange	P-2011	65.07	12/1

Isolation Ball Valve - Rotating Flange & Purge

Forged brass
ISO 9002, 600 CWP
Bolt set included



T-2012RFLG



S-2012RFLG

101-174	3/4"	FNPT x Flange	T-2012RFLG	44.34	24/1
101-175	1"	FNPT x Flange	T-2012RFLG	52.41	18/1
101-176	1-1/4"	FNPT x Flange	T-2012RFLG	66.71	12/1
101-194	3/4"	Sweat x Flange	S-2012RFLG	44.34	24/1
101-195	1"	Sweat x Flange	S-2012RFLG	52.41	18/1
101-196	1-1/4"	Sweat x Flange	S-2012RFLG	66.71	12/1

Rotating flange for greater installation ease. Purge feature saves system down time.

LEGENDPRESS™ BALL VALVES

LegendPress™ Ball Valve

Traditional & no lead forged brass
ISO 9002
600 CWP (1/2", 3/4"),
500 CWP (1", 1-1/4")
400 CWP (1-1/2" - 4")
NSF 61-G Listed (P-200NL)



P-200

101-003	1/2"	Press x Press	P-200	19.29	50/5
101-003NL	1/2"	Press x Press	P-200NL	22.25	50/5
101-004	3/4"	Press x Press	P-200	28.89	30/5
101-004NL	3/4"	Press x Press	P-200NL	32.41	30/5
101-005	1"	Press x Press	P-200	41.56	18/3
101-005NL	1"	Press x Press	P-200NL	46.79	18/3
101-006	1-1/4"	Press x Press	P-200	61.90	12/2
101-006NL	1-1/4"	Press x Press	P-200NL	70.34	12/2
101-007	1-1/2"	Press x Press	P-200	108.51	10/2
101-007NL	1-1/2"	Press x Press	P-200NL	121.81	10/2
101-008	2"	Press x Press	P-200	147.38	8/2
101-008NL	2"	Press x Press	P-200NL	164.88	8/2
101-009	2-1/2"	Press x Press	P-200	287.85	2/1
101-009NL	2-1/2"	Press x Press	P-200NL	314.04	2/1
101-010	3"	Press x Press	P-200	419.93	2/1
101-010NL	3"	Press x Press	P-200NL	474.91	2/1
101-011	4"	Press x Press	P-200	772.82	- / -
101-011NL	4"	Press x Press	P-200NL	851.85	- / -

PUSH FIT BALL VALVES

Insta-Loc II™ Push Fit Ball Valve

No lead DZR forged brass
200 CWP, max. temp 250°F, DZR brass
ANSI/NSF 61-G, NSF 14, ASSE 1061
ISO 9002, UPC/IAPMO



P-2200NL

456-003NL	1/2"	Push x Push	P-2200NL	20.17	100/10
456-004NL	3/4"	Push x Push	P-2200NL	27.37	100/10
456-005NL	1"	Push x Push	P-2200NL	42.04	50/5



PUSH FIT BALL VALVES

Insta-Loc II™ No Lead Drop Ear Push Fit Ball Valve

No lead DZR forged brass, ISO 9002
200 CW/P, Max. temp. 250°F
ANSI/NSF 61-G, NSF 14, ASSE 1061
UPC/IAPMO



P-2200NL Drop Ear



P-2200NL

	Part No.	Size	Configuration	Model No.	List Price	Cs/Ct
NEW	456-023NL	1/2"	Push x Push	P-2200NL Drop Ear	21.81	10
NEW	456-024NL	3/4"	Push x Push	P-2200NL Drop Ear	31.25	10
NEW	456-025NL	1"	Push x Push	P-2200NL Drop Ear	55.47	5
NEW	456-013NL	1/2"	Push x FNPT	P-2200NL	21.25	10
NEW	456-014NL	3/4"	Push x FNPT	P-2200NL	29.89	10
NEW	456-015NL	1"	Push x FNPT	P-2200NL	58.28	5

PEX BALL VALVES

PEX End Ball Valve

No lead forged brass
ANSI/NSF 61-G
ASTM F 1807, ISO 9002
400 CWP



T-806NL



T-805NL
Sweat x PEX



T-805NL
MNPT x PEX

	101-582NL	3/8"	PEX x PEX	T-806NL	13.95	100/10
	101-585NL	1/2"	PEX x PEX	T-806NL	10.53	120/10
	101-586NL	3/4"	PEX x PEX	T-806NL	13.58	120/10
	101-587NL	1"	PEX x PEX	T-806NL	19.67	50/5
	101-583NL	1/2"	Sweat x PEX	T-805NL	15.06	100/10
	101-584NL	3/4"	Sweat x PEX	T-805NL	17.76	100/10
	101-580NL	1/2"	MNPT x PEX	T-805NL	16.30	100/10
	101-581NL	3/4"	MNPT x PEX	T-805NL	19.11	100/10

PEX End Ball Valve

No lead DZR forged brass
400 CW/P, DZR, ANSI/NSF 61-G,
NSF 14, ISO 9002,
ASTM F 1807



T-2006NL
PEX x PEX



T-2006NL
Tee handle

	101-593NL	1/2"	PEX x PEX	T-2006NL	7.65	100/10
	101-594NL	3/4"	PEX x PEX	T-2006NL	10.92	100/10
	101-595NL	1"	PEX x PEX	T-2006NL	18.99	60/12
	101-588NL	1-1/4"	PEX x PEX	T-2006NL	26.76	60/12
NEW	101-573NL	1-1/2"	PEX x PEX	T-2006NL	36.56	16/4
NEW	101-574NL	2"	PEX x PEX	T-2006NL	61.49	8/2
	Tee Handle					
NEW	101-579NL	1/2"	PEX x PEX	T-2006NL	8.05	100/10
NEW	101-589NL	3/4"	PEX x PEX	T-2006NL	11.49	10/10

PEX BALL VALVES

PEX End Ball Valve (cont.)

No lead DZR forged brass
400 CWP, ANSI/NSF 61-G NSF 14,
ASTM F 1807, ISO 9002



T-2007NL
PEX x PEX



T-2007NL
Sweat x PEX



T-2005NL
MNPT x PEX



T-2008NL
PEX x PEX

Part No.	Size	Configuration	Model No.	List Price	Cs/Ct
----------	------	---------------	-----------	------------	-------

Tee Handle & Drainable

101-596NL	1/2"	PEX x PEX	T-2007NL	10.31	80/8
101-597NL	3/4"	PEX x PEX	T-2007NL	13.27	80/8
101-598NL	1"	PEX x PEX	T-2007NL	23.10	80/8
101-600NL	1/2"	Sweat x PEX	T-2007NL	10.17	80/8
101-601NL	3/4"	Sweat x PEX	T-2007NL	13.83	80/8
101-602NL	1"	Sweat x PEX	T-2007NL	23.01	80/8
101-590NL	1/2"	MNPT x PEX	T-2005NL	8.50	100/10
101-591NL	3/4"	MNPT x PEX	T-2005NL	12.33	80/8
101-592NL	1"	MNPT x PEX	T-2005NL	21.84	48/6

Drop Ear

101-576NL	1/2"	PEX x PEX	T-2008NL	9.99	80/8
101-577NL	3/4"	PEX x PEX	T-2008NL	13.15	64/8
NEW 101-578NL	1"	PEX x PEX	T-2008NL	20.47	36/6

PEX End Ball Valve (Cold Expansion)

No lead DZR forged brass
400 CWP, ISO 9002, UPC/IAPMO
ANSI/NSF 61-G, NSF 14
ASTM F 1960 cold expansion



T-1960NL



Drop Ear & Drain



MNPT x PEX

NEW 101-543NL	1/2"	PEX x PEX	T-1960NL	8.25	100/10
NEW 101-544NL	3/4"	PEX x PEX	T-1960NL	13.06	100/10
NEW 101-545NL	1"	PEX x PEX	T-1960NL	21.76	60/12
NEW 101-546NL	1-1/4"	PEX x PEX	T-1960NL	38.92	24/6
NEW 101-547NL	1-1/2"	PEX x PEX	T-1960NL	46.63	16/4
NEW 101-548NL	2"	PEX x PEX	T-1960NL	86.40	8/2

Drainable with Drop Ear

NEW 101-563NL	1/2"	PEX x PEX	T-1960NL	11.69	48/6
NEW 101-564NL	3/4"	PEX x PEX	T-1960NL	16.76	48/6
NEW 101-565NL	1"	PEX x PEX	T-1960NL	29.91	36/6
NEW 101-463NL	1/2"	MNPT x PEX	T-1960NL	8.75	100/10
NEW 101-464NL	3/4"	MNPT x PEX	T-1960NL	12.99	80/8
NEW 101-465NL	1"	MNPT x PEX	T-1960NL	22.67	48/6

Did you know? Legend does not have a minimum order.



MINI BALL VALVES

MNPT x FNPT Large Port Ball Valves

ISO 9002, 600 CWP (1/8" - 3/4"), 500 CWP (1" only)
150 WSP
CSA certified (1/2" - 1")
UL listed (1/2" - 1") - T-900 only not NL
NSF 61-G (T-900NL)



T-900
MNPT x FNPT

Part No.	Size	Configuration	Model No.	List Price	Cs/Ct
101-520	1/8"	MNPT x FNPT	T-900MxF	12.39	200/20
101-520NL	1/8"	MNPT x FNPT	T-900MxFNL	16.09	200/20
101-521	1/4"	MNPT x FNPT	T-900MxF	12.39	200/20
101-521NL	1/4"	MNPT x FNPT	T-900MxFNL	16.09	200/20
101-522	3/8"	MNPT x FNPT	T-900MxF	16.08	100/10
101-522NL	3/8"	MNPT x FNPT	T-900MxFNL	20.93	100/10
101-523	1/2"	MNPT x FNPT	T-900MxF	17.92	100/10
101-523NL	1/2"	MNPT x FNPT	T-900MxFNL	20.93	100/10
101-524	3/4"	MNPT x FNPT	T-900MxF	29.71	60/10
101-524NL	3/4"	MNPT x FNPT	T-900MxFNL	37.87	60/10
101-525	1"	MNPT x FNPT	T-900MxF	43.39	36/6
101-525NL	1"	MNPT x FNPT	T-900MxFNL	54.13	36/6

MNPT x FNPT Ball Valve with Tee Handle

ISO 9002, 400 CWP, 125 WSP
NSF 61-G, (T-800TNL)



T-900
MNPT x FNPT-TNL

101-530	1/8"	MNPT x FNPT	T-900MxF-T	12.39	200/20
101-530NL	1/8"	MNPT x FNPT	T-900MxF-TNL	16.09	200/20
101-531	1/4"	MNPT x FNPT	T-900MxF-T	12.39	200/20
101-531NL	1/4"	MNPT x FNPT	T-900MxF-TNL	16.09	200/20
101-532	3/8"	MNPT x FNPT	T-900MxF-T	15.59	100/10
101-532NL	3/8"	MNPT x FNPT	T-900MxF-TNL	20.30	100/10
101-533	1/2"	MNPT x FNPT	T-900MxF-T	17.02	100/10
101-533NL	1/2"	MNPT x FNPT	T-900MxF-TNL	19.88	100/10
101-534	3/4"	MNPT x FNPT	T-900MxF-T	28.82	60/10
101-534NL	3/4"	MNPT x FNPT	T-900MxF-TNL	36.73	60/10
101-535	1"	MNPT x FNPT	T-900MxF-T	37.00	36/6
101-535NL	1"	MNPT x FNPT	T-900MxF-TNL	46.99	36/6

MICRO BALL™ Lever Handle

ISO 9002, 400 CWP, 125 WSP



T-810

101-000	1/8"	FNPT x FNPT	T-810	10.00	200/20
101-001	1/4"	FNPT x FNPT	T-810	9.00	200/20

MICRO BALL™ Tee Handle

ISO 9002, 400 CWP, 125 WSP
NSF 61-G, (T-800TNL)



T-800T



101-540	1/8"	FNPT x FNPT	T-800T	9.70	200/20
101-540NL	1/8"	FNPT x FNPT	T-800TNL	12.85	200/20
101-541	1/4"	FNPT x FNPT	T-800T	8.73	200/20
101-541NL	1/4"	FNPT x FNPT	T-800TNL	10.63	200/20

Ball Valve Test Cock, Screwdriver Slot

ISO 9002, 600 CWP, 150 WSP
ANSI/NSF 61-G
Third party certified Truesdail



T-801NL



101-550NL	1/4" x 1/8"	FNPT x MNPT	T-801NL	10.61	200/20
101-551NL	1/4"	FNPT x MNPT	T-801NL	10.61	200/20

MINI BALL VALVES

Stainless Steel Mini Ball Valve

ISO 9002, 800 CWP, 150 WSP
with tee handle
Naturally lead free



Part No.	Size	Configuration	Model No.	List Price	Cs/Ct
113-301	1/4"	FNPT x FNPT	T-710T	36.89	240/60
113-311	1/4"	MNPT x FNPT	T-710MxF-T	34.00	240/60

BALL VALVE ACCESSORIES

Accessories

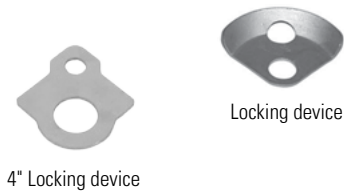

4" Locking device



Locking device

Fits Models 1001, 1004, 1100, 1009, 806, P-200. Does not fit T-handle ball valves

101-954	1/4" - 1/2"	Locking Device	5.00	- / -
101-955	3/4" - 1-1/4"	Locking Device	6.08	- / -
101-956	1-1/2" - 2"	Locking Device	9.22	- / -
101-957	2-1/2" - 3"	Locking Device	11.71	- / -
NEW 101-950	4"	Locking Device	15.80	20



Memory stop

Fits Models 1001, 1004, 1100, 1009, 806, P-200

101-951	1/4" - 1/2"	Memory Stop	4.76	- / -
101-952	3/4" - 1-1/4"	Memory Stop	4.76	- / -
101-953	1-1/2" - 2"	Memory Stop	4.76	- / -



Stem extension

Fits Models 1001, 1004, 1100, 1009, 806, 805, P-200

101-958*	3/8" - 1/2"	Stem Extension	8.98	- / -
101-959	3/4" - 1-1/4"	Stem Extension	11.04	- / -
101-960	1-1/2" - 2"	Stem Extension	20.53	- / -
101-964	2-1/2" - 3"	Stem Extension	29.40	- / -
101-965	4"	Stem Extension	40.97	- / -

*101-958 fits 1/2" & 3/4" T-806 PEX ball valves



Extension handle

Fits Models 1001, 1004, 1100, 1009, 806, 805, P-200

101-931	3/8" - 1/2"	Extension Handle	7.67	- / -
101-932	3/4" - 1-1/4"	Extension Handle	7.85	- / -
101-933	1-1/2" - 2"	Extension Handle	10.21	- / -



T-Handle

Fits Models 1001, 1004, 1100, 1009, 806, 805, P-200

101-961	1/8" - 1/4"	T-handle	6.59	- / -
101-962	3/8" - 1/2"	T-handle	6.99	- / -
101-963	3/4" - 1-1/4"	T-handle	7.59	- / -



Handle & Nut

Fits Model T/S-1002

101-982	1/4" - 1/2"	Stainless Steel	Handle & Nut	6.59	- / -
101-983	3/4" - 1"	Stainless Steel	Handle & Nut	10.41	- / -
101-984	1-1/4" - 1-1/2"	Stainless Steel	Handle & Nut	15.97	- / -
101-985	2" - 3"	Stainless Steel	Handle & Nut	31.66	- / -



STAINLESS STEEL BALL VALVES - INVESTMENT CAST

3-Piece 316 Stainless Steel Full Port Ball Valve

ISO 9002, 1000 CWP, 150 WSP
Naturally lead free



T-717

Part No.	Size	Configuration	Model No.	List Price	Cs/Ct
113-161	1/4"	FNPT x FNPT	T-717	45.40	48/12
113-162	3/8"	FNPT x FNPT	T-717	45.40	48/12
113-163	1/2"	FNPT x FNPT	T-717	57.23	36/9
113-164	3/4"	FNPT x FNPT	T-717	70.75	32/8
113-165	1"	FNPT x FNPT	T-717	96.84	24/6
113-166	1-1/4"	FNPT x FNPT	T-717	144.28	16/4
113-167	1-1/2"	FNPT x FNPT	T-717	201.63	8/2
113-168	2"	FNPT x FNPT	T-717	285.47	8/2

2-Piece 316 Stainless Steel Full Port Ball Valve

ISO 9002, 1000 CWP, 150 WSP
Naturally lead free



T-712

113-141	1/4"	FNPT x FNPT	T-712	36.67	80/10
113-142	3/8"	FNPT x FNPT	T-712	36.67	80/10
113-143	1/2"	FNPT x FNPT	T-712	45.01	80/10
113-144	3/4"	FNPT x FNPT	T-712	58.35	60/10
113-145	1"	FNPT x FNPT	T-712	83.91	36/6
113-146	1-1/4"	FNPT x FNPT	T-712	118.70	24/6
113-147	1-1/2"	FNPT x FNPT	T-712	165.65	12/2
113-148	2"	FNPT x FNPT	T-712	225.00	8/2
113-109	2-1/2"	FNPT x FNPT	T-712	666.80	4/1
113-110	3"	FNPT x FNPT	T-712	763.30	- / -
113-111	4"	FNPT x FNPT	T-712	1649.53	- / -

2-Piece 316 Stainless Steel Large Port Ball Valve

ISO 9002, 150 WSP
2000 CWP (1/4" - 1")
1500 CWP (1-1/4" - 2")
Naturally lead free



T-715

113-101	1/4"	FNPT x FNPT	T-715	38.00	80/10
113-102	3/8"	FNPT x FNPT	T-715	38.00	80/10
113-103	1/2"	FNPT x FNPT	T-715	43.66	60/10
113-104	3/4"	FNPT x FNPT	T-715	58.35	60/10
113-105	1"	FNPT x FNPT	T-715	83.50	36/6
113-106	1-1/4"	FNPT x FNPT	T-715	106.53	24/6
113-107	1-1/2"	FNPT x FNPT	T-715	139.15	16/4
113-108	2"	FNPT x FNPT	T-715	205.08	8/2

1-Piece 316 Stainless Steel Conv. Port Ball Valve

ISO 9002, 800 CWP, 150 WSP
Naturally lead free



T-710

113-120*	1/8"	FNPT x FNPT	T-710	34.52	160/10
113-121	1/4"	FNPT x FNPT	T-710	25.03	160/10
113-122	3/8"	FNPT x FNPT	T-710	26.74	160/10
113-123	1/2"	FNPT x FNPT	T-710	32.81	100/10
113-124	3/4"	FNPT x FNPT	T-710	39.49	80/10
113-125	1"	FNPT x FNPT	T-710	58.79	48/6
113-126	1-1/4"	FNPT x FNPT	T-710	78.46	24/6
113-127	1-1/2"	FNPT x FNPT	T-710	97.89	16/4
113-128	2"	FNPT x FNPT	T-710	123.66	8/2

*Note: 1/8" not locking

CARBON STEEL BALL VALVES - INVESTMENT CAST

2-Piece Carbon Steel Full Port Ball Valve

ISO 9002, 150 WSP
2000 CWP (1/4" - 1")
1500 CWP (1-1/4" - 2")
MSS-SP110
Naturally lead free



T-730

Part No.	Size	Configuration	Model No.	List Price	Cs/Ct
113-221	1/4"	FNPT x FNPT	T-730	35.15	80/10
113-222	3/8"	FNPT x FNPT	T-730	35.15	80/10
113-223	1/2"	FNPT x FNPT	T-730	41.05	60/10
113-224	3/4"	FNPT x FNPT	T-730	51.00	60/10
113-225	1"	FNPT x FNPT	T-730	73.15	36/6
113-226	1-1/4"	FNPT x FNPT	T-730	98.27	24/6
113-227	1-1/2"	FNPT x FNPT	T-730	141.57	12/2
113-228	2"	FNPT x FNPT	T-730	201.51	8/2

2-Piece Carbon Steel Large Port Ball Valve

ISO 9002, 150 WSP
2000 CWP (1/4" - 1")
1500 CWP (1-1/4" - 2")
Naturally lead free



T-725

113-211	1/4"	FNPT x FNPT	T-725	36.33	80/10
113-212	3/8"	FNPT x FNPT	T-725	36.33	80/10
113-213	1/2"	FNPT x FNPT	T-725	40.81	60/10
113-214	3/4"	FNPT x FNPT	T-725	54.33	60/10
113-215	1"	FNPT x FNPT	T-725	80.98	36/6
113-216	1-1/4"	FNPT x FNPT	T-725	99.20	24/4
113-217	1-1/2"	FNPT x FNPT	T-725	129.49	16/4
113-218	2"	FNPT x FNPT	T-725	177.46	8/2

1-Piece Carbon Steel Conv. Port Ball Valve

ISO 9002
2000 CWP (1/4" - 1"), 150 WSP
1500 CWP (1-1/4" - 2")
Naturally lead free



T-720

113-201	1/4"	FNPT x FNPT	T-720	24.79	160/10
113-202	3/8"	FNPT x FNPT	T-720	26.89	160/10
113-203	1/2"	FNPT x FNPT	T-720	33.26	60/10
113-204	3/4"	FNPT x FNPT	T-720	40.17	40/10
113-205	1"	FNPT x FNPT	T-720	49.95	36/6
113-206	1-1/4"	FNPT x FNPT	T-720	85.58	24/6
113-207	1-1/2"	FNPT x FNPT	T-720	102.35	16/4
113-208	2"	FNPT x FNPT	T-720	112.29	8/2

GAS BALL VALVES

Drip Leg Kit



102-836

Includes 1/2" x 3" & 1/2" X 6" Black Nipples, 1/2" Union, Tee, Cap & Valve

102-836	1/2" Kit with T-3000	25.51	- / -
102-837	1/2" Kit with T-3005	23.97	- / -

Blue Top™ Patented One-Piece Design

Forged brass, 175 psi
CSA Certified, UL listed (1/2" & 3/4" only)
ISO 9002



T-3000



Flare x FNPT
T-3000

See T-1001 on page 10 for 1-1/4" to 3" CSA gas ball valves

102-102	3/8"	FNPT x FNPT	T-3000	13.08	100/10
102-103	1/2"	FNPT x FNPT	T-3000	9.48	100/10
102-104	3/4"	FNPT x FNPT	T-3000	14.01	100/10
102-112	3/8" x 1/2"	Flare x FNPT	T-3000	12.45	100/10
102-113	1/2" x 1/2"	Flare x FNPT	T-3000	12.45	100/10
102-118	1/2" x 3/4"	Flare x FNPT	T-3000	21.24	100/10



GAS BALL VALVES

Blue Top™ Patented One-Piece Design (cont.)

Forged brass, 175 psi
CSA certified, UL listed (1/2" & 3/4" only)
ISO 9002



Flare x MNPT
T-3000



Flare x Flare
T-3000



Flare x FNPT T-3000



FNPT x Texas
Pattern-3000



T-3000A Angle

Massachusetts Code



T-3001



T-3002



FNPT x FNPT
T-3100



Flare x Flare
T-3100

Part No.	Size	Configuration	Model No.	List Price	Cs/Ct
102-121	5/8" (15/16-16) x 1/2"	Flare x FNPT	T-3000	17.68	100/10
102-114	5/8" (7/8-14) x 3/4"	Flare x FNPT	T-3000	22.16	100/10
102-115	5/8" (15/16-16) x 3/4"	Flare x FNPT	T-3000	22.16	100/10
102-212	3/8" x 1/2"	Flare x MNPT	T-3000	14.87	100/10
102-213	1/2" x 1/2"	Flare x MNPT	T-3000	14.87	100/10
102-312	3/8" x 3/8"	Flare x Flare	T-3000	15.79	100/10
102-313	1/2" x 1/2"	Flare x Flare	T-3000	15.79	100/10
102-314	5/8" x 5/8"	Flare x Flare	T-3000	24.50	100/10
102-413	1/2" x 1/8"	FNPT x Texas	T-3000	16.23	100/10
102-414	3/4" x 1/8"	FNPT x Texas	T-3000	22.08	100/10
102-119	3/8" (9/16-24) x 1/2"	Flare x FNPT	T-3000 Heater Valve	15.62	100/10
Angle Valve					
102-122	3/8" x 1/2"	Flare x FNPT	T-3000A	20.81	100/10
102-120	5/8" (15/16-16) x 3/4"	Flare x FNPT	T-3000A	27.84	100/10
102-612	3/8"	FNPT x FNPT	T-3001 T-handle	12.01	100/10
102-613	1/2"	FNPT x FNPT	T-3001 T-handle	9.46	100/10
102-614	3/4"	FNPT x FNPT	T-3001 T-handle	14.75	100/10
102-615	1"	FNPT x FNPT	T-3001 T-handle	30.40	36/6
102-616	1-1/4"	FNPT x FNPT	T-3001 T-handle	61.00	24/4
102-617	1-1/2"	FNPT x FNPT	T-3001 T-handle	77.60	24/4
102-618	2"	FNPT x FNPT	T-3001 T-handle	103.66	12/2
102-713	1/2"	FNPT x FNPT	T-3002 Flathead	11.39	100/10
102-714	3/4"	FNPT x FNPT	T-3002 Flathead	14.16	100/10
102-513	1/2"	FNPT x FNPT	T-3100 Sidetap	15.79	100/10
102-514	3/4"	FNPT x FNPT	T-3100 Sidetap	22.08	100/10
102-515	1"	FNPT x FNPT	T-3100 Sidetap	37.61	36/6
102-522	3/8"	Flare x Flare	T-3100 Sidetap	20.61	100/10
102-523	1/2"	Flare x Flare	T-3100 Sidetap	21.69	100/10

Red Top™ Economy Gas Ball Valve

Forged brass
400 psi, CSA Certified
UL Listed (1/2" & 3/4")
Massachusetts code compliant
ISO 9002



T-3005

102-903	1/2"	FNPT x FNPT	T-3005	7.32	144/12
102-904	3/4"	FNPT x FNPT	T-3005	10.94	144/12
102-905	1"	FNPT x FNPT	T-3005	20.13	60/6

STAINLESS STEEL GATE VALVES

316 Stainless Steel Gate Valve

600 CWP, 125 WSP
Naturally lead free



T-751

Part No.	Size	Configuration	Model No.	List Price	Cs/Ct
113-403	1/2"	FNPT x FNPT	T-751	81.57	48/12
113-404	3/4"	FNPT x FNPT	T-751	87.71	48/12
113-405	1"	FNPT x FNPT	T-751	137.77	40/10
113-406	1-1/4"	FNPT x FNPT	T-751	175.00	20/5
113-407	1-1/2"	FNPT x FNPT	T-751	238.41	16/4
113-408	2"	FNPT x FNPT	T-751	248.83	8/2

BRONZE GATE VALVES

Rising Stem

300 CWP, 150 WSP, conforms to MSS SP-80



T-416

104-613	1/2"	FNPT x FNPT	T-416	41.75	84/6
104-614	3/4"	FNPT x FNPT	T-416	62.27	50/5
104-615	1"	FNPT x FNPT	T-416	93.64	35/5
104-616	1-1/4"	FNPT x FNPT	T-416	126.22	28/4
104-617	1-1/2"	FNPT x FNPT	T-416	169.00	16/4
104-618	2"	FNPT x FNPT	T-416	242.37	12/1

Screw-Over Bonnet

ISO 9002, 200 CWP, 125 WSP, conforms to MSS SP-80



S-414



T-414

104-653	1/2"	FNPT x FNPT	T-414	18.47	120/6
104-654	3/4"	FNPT x FNPT	T-414	25.69	84/6
104-655	1"	FNPT x FNPT	T-414	34.86	60/5
104-656	1-1/4"	FNPT x FNPT	T-414	47.26	40/4
104-657	1-1/2"	FNPT x FNPT	T-414	65.46	28/4
104-658	2"	FNPT x FNPT	T-414	99.17	18/3
104-663	1/2"	Sweat x Sweat	S-414	18.47	120/6
104-664	3/4"	Sweat x Sweat	S-414	25.69	84/6
104-665	1"	Sweat x Sweat	S-414	34.86	60/5
104-666	1-1/4"	Sweat x Sweat	S-414	47.26	40/4
104-667	1-1/2"	Sweat x Sweat	S-414	65.46	28/4
104-668	2"	Sweat x Sweat	S-414	99.17	18/3

Inserted Bonnet

ISO 9002, 200 CWP, 125 WSP



T-415

104-501	1/4"	FNPT x FNPT	T-415	18.34	120/10
104-502	3/8"	FNPT x FNPT	T-415	18.34	120/10
104-503	1/2"	FNPT x FNPT	T-415	18.34	120/10
104-504	3/4"	FNPT x FNPT	T-415	25.72	90/10
104-505	1"	FNPT x FNPT	T-415	37.20	60/5
104-506	1-1/4"	FNPT x FNPT	T-415	56.49	40/5
104-507	1-1/2"	FNPT x FNPT	T-415	72.25	32/4
104-508	2"	FNPT x FNPT	T-415	110.75	20/2
104-509	2-1/2"	FNPT x FNPT	T-415	233.87	12/2
104-510	3"	FNPT x FNPT	T-415	351.70	8/1
104-511	4"	FNPT x FNPT	T-415	687.09	4/1



BRONZE GATE VALVES

Inserted Bonnet (cont.)	Part No.	Size	Configuration	Model No.	List Price	Cs/Ct
ISO 9002, 200 CWP, 125 WSP	104-603	1/2"	Sweat x Sweat	S-415	18.34	120/10
	104-604	3/4"	Sweat x Sweat	S-415	25.72	90/10
	104-605	1"	Sweat x Sweat	S-415	37.20	60/5
	104-606	1-1/4"	Sweat x Sweat	S-415	56.49	40/5
	104-607	1-1/2"	Sweat x Sweat	S-415	72.25	32/4
	104-608	2"	Sweat x Sweat	S-415	110.75	20/2
	104-609	2-1/2"	Sweat x Sweat	S-415	233.87	10/2
	104-610	3"	Sweat x Sweat	S-415	351.70	6/2
	104-611	4"	Sweat x Sweat	S-415	687.09	4/1



S-415

T-420 Quick Opening Gate Valve

TPR coated handle
200 CWP



T-420

104-416	3"	FNPT x FNPT	T-420	189.00	1
104-417	4"	FNPT x FNPT	T-420	325.55	1

T-420 Brass Handle

Replacement handle for T-420 quick opening gate valve.



T-420

104-414	3"	Handle	T-420	14.99	50/10
104-415	4"	Handle	T-420	15.29	50/10

BRASS GATE VALVES

Brass Gate Valve

Traditional & no lead brass
ISO 9002, 200 CWP
ANSI/NSF 61-G (T/S-401NL)



T-401

104-301	1/4"	FNPT x FNPT	T-401	11.99	120/10
104-302	3/8"	FNPT x FNPT	T-401	11.83	120/10
104-303	1/2"	FNPT x FNPT	T-401	11.09	120/10
104-303NL	1/2"	FNPT x FNPT	T-401NL	15.02	120/10
104-304	3/4"	FNPT x FNPT	T-401	15.67	90/10
104-304NL	3/4"	FNPT x FNPT	T-401NL	20.56	90/10
104-305	1"	FNPT x FNPT	T-401	24.23	60/5
104-305NL	1"	FNPT x FNPT	T-401NL	32.64	60/5
104-306	1-1/4"	FNPT x FNPT	T-401	34.75	40/5
104-306NL	1-1/4"	FNPT x FNPT	T-401NL	45.70	40/5
104-307	1-1/2"	FNPT x FNPT	T-401	41.58	32/4
104-307NL	1-1/2"	FNPT x FNPT	T-401NL	54.93	32/4
104-308	2"	FNPT x FNPT	T-401	63.28	20/2
104-308NL	2"	FNPT x FNPT	T-401NL	86.77	20/2
104-309	2-1/2"	FNPT x FNPT	T-401	144.45	12/2
104-310	3"	FNPT x FNPT	T-401	188.33	8/1
104-311	4"	FNPT x FNPT	T-401	339.36	8/1

BRASS GATE VALVES

Brass Gate Valve (cont.)

Traditional & no lead brass
ISO 9002, 200 CWP
ANSI/NSF 61-G (T/S-401NL)



S-401

Part No.	Size	Configuration	Model No.	List Price	Cs/Ct
104-403	1/2"	Sweat x Sweat	S-401	11.09	120/10
104-403NL	1/2"	Sweat x Sweat	S-401NL	15.02	120/10
104-404	3/4"	Sweat x Sweat	S-401	15.67	90/10
104-404NL	3/4"	Sweat x Sweat	S-401NL	20.56	90/10
104-405	1"	Sweat x Sweat	S-401	24.23	60/5
104-405NL	1"	Sweat x Sweat	S-401NL	32.64	60/5
104-406	1-1/4"	Sweat x Sweat	S-401	34.75	40/5
104-406NL	1-1/4"	Sweat x Sweat	S-401NL	45.70	40/5
104-407	1-1/2"	Sweat x Sweat	S-401	41.58	32/4
104-407NL	1-1/2"	Sweat x Sweat	S-401NL	54.93	32/4
104-408	2"	Sweat x Sweat	S-401	63.28	20/2
104-408NL	2"	Sweat x Sweat	S-401NL	86.77	20/2
104-409	2-1/2"	Sweat x Sweat	S-401	144.45	12/2
104-410	3"	Sweat x Sweat	S-401	188.33	8/1

Economy Brass Gate Valve

Traditional & no lead brass
ISO 9002, 200 CWP
NSF 61-G (T/S-408NL)



T-408

104-703	1/2"	FNPT x FNPT	T-408	10.44	120/10
104-703NL	1/2"	FNPT x FNPT	T-408NL	14.41	120/10
104-704	3/4"	FNPT x FNPT	T-408	13.97	80/10
104-704NL	3/4"	FNPT x FNPT	T-408NL	19.64	80/10
104-705	1"	FNPT x FNPT	T-408	20.52	60/5
104-705NL	1"	FNPT x FNPT	T-408NL	31.01	60/5
104-706	1-1/4"	FNPT x FNPT	T-408	30.35	40/5
104-706NL	1-1/4"	FNPT x FNPT	T-408NL	41.16	40/5
104-707	1-1/2"	FNPT x FNPT	T-408	37.45	30/5
104-707NL	1-1/2"	FNPT x FNPT	T-408NL	52.35	30/5
104-708	2"	FNPT x FNPT	T-408	57.58	24/2
104-708NL	2"	FNPT x FNPT	T-408NL	79.62	24/2
104-709	2-1/2"	FNPT x FNPT	T-408	125.40	10/1
104-709NL	2-1/2"	FNPT x FNPT	T-408NL	161.87	10/1
104-710	3"	FNPT x FNPT	T-408	159.50	6/1
104-710NL	3"	FNPT x FNPT	T-408NL	214.39	6/1
104-711	4"	FNPT x FNPT	T-408	280.49	4/1
104-711NL	4"	FNPT x FNPT	T-408NL	366.06	4/1



S-408

104-723	1/2"	Sweat x Sweat	S-408	10.44	120/10
104-723NL	1/2"	Sweat x Sweat	S-408NL	14.41	120/10
104-724	3/4"	Sweat x Sweat	S-408	13.97	80/10
104-724NL	3/4"	Sweat x Sweat	S-408NL	19.64	80/10
104-725	1"	Sweat x Sweat	S-408	20.52	60/5
104-725NL	1"	Sweat x Sweat	S-408NL	31.01	60/5
104-726	1-1/4"	Sweat x Sweat	S-408	30.35	40/5
104-726NL	1-1/4"	Sweat x Sweat	S-408NL	41.16	40/5
104-727	1-1/2"	Sweat x Sweat	S-408	37.45	30/5
104-727NL	1-1/2"	Sweat x Sweat	S-408NL	52.35	30/5
104-728	2"	Sweat x Sweat	S-408	57.58	24/2
104-728NL	2"	Sweat x Sweat	S-408NL	79.62	24/2

GATE, CHECK, LOW PRESSURE VALVES & Y-STRAINERS



BRASS GATE VALVES

Cross Handle Gate Valve

200 CWP
ISO 9002



T-408X

Part No.	Size	Configuration	Model No.	List Price	Cs/Ct
104-733	1/2"	FNPT x FNPT	T-408X	12.12	120/10
104-734	3/4"	FNPT x FNPT	T-408X	16.25	80/20
104-735	1"	FNPT x FNPT	T-408X	23.24	60/5
104-736	1-1/4"	FNPT x FNPT	T-408X	33.12	40/5
104-737	1-1/2"	FNPT x FNPT	T-408X	41.71	30/5
104-738	2"	FNPT x FNPT	T-408X	62.78	24/2

Compact Pattern Conventional Port

Traditional & no lead brass
ISO 9002, 200 CWP
ANSI/NSF 61-G (T/S-400NL)
Third party certified Truesdail



T-400

104-463	1/2"	FNPT x FNPT	T-400	9.17	160/10
104-463NL	1/2"	FNPT x FNPT	T-400NL	11.45	160/10
104-464	3/4"	FNPT x FNPT	T-400	12.14	100/10
104-464NL	3/4"	FNPT x FNPT	T-400NL	15.16	100/10
104-465	1"	FNPT x FNPT	T-400	16.53	80/8
104-465NL	1"	FNPT x FNPT	T-400NL	20.64	80/8
104-466	1-1/4"	FNPT x FNPT	T-400	23.45	50/5
104-466NL	1-1/4"	FNPT x FNPT	T-400NL	29.28	50/5
104-467	1-1/2"	FNPT x FNPT	T-400	33.57	40/4
104-467NL	1-1/2"	FNPT x FNPT	T-400NL	41.91	40/4
104-468	2"	FNPT x FNPT	T-400	43.98	30/3
104-468NL	2"	FNPT x FNPT	T-400NL	54.91	30/3
104-469	2-1/2"	FNPT x FNPT	T-400	82.87	20/2
104-470	3"	FNPT x FNPT	T-400	131.54	12/2
104-471	4"	FNPT x FNPT	T-400	233.14	8/1



S-400

104-473	1/2"	Sweat x Sweat	S-400	9.17	160/10
104-473NL	1/2"	Sweat x Sweat	S-400NL	11.45	160/10
104-474	3/4"	Sweat x Sweat	S-400	12.14	100/10
104-474NL	3/4"	Sweat x Sweat	S-400NL	15.16	100/10
104-475	1"	Sweat x Sweat	S-400	16.53	80/8
104-475NL	1"	Sweat x Sweat	S-400NL	20.64	80/8
104-476	1-1/4"	Sweat x Sweat	S-400	23.45	50/5
104-476NL	1-1/4"	Sweat x Sweat	S-400NL	29.28	50/5
104-477	1-1/2"	Sweat x Sweat	S-400	33.57	40/4
104-477NL	1-1/2"	Sweat x Sweat	S-400NL	41.91	40/4
104-478	2"	Sweat x Sweat	S-400	43.98	30/2
104-478NL	2"	Sweat x Sweat	S-400NL	54.91	30/2

Brass Cross Handle

Fits 414, 415, 401, 400, & 408 series gate valves



Cross Handle

Fits Valve sizes...

104-451	1/4" - 3/4"*	Cross Handle	3.86	- / -
104-452	1"	Cross Handle	3.86	- / -
104-453	1-1/4" - 1-1/2"	Cross Handle	3.86	- / -
104-454	2" - 2-1/2"	Cross Handle	3.86	- / -
104-455	3"	Cross Handle	7.34	- / -
104-456	4"	Cross Handle	7.35	- / -

*Fits T-501 stop valve

GLOBE VALVES

Bronze Globe Valve

Traditional & no lead bronze
200 CWP, 125 WSP to 350° F max temp
ANSI/NSF 372 (T-421NL)



T-421

Part No.	Size	Configuration	Model No.	List Price	Cs/Ct
103-103	1/2"	FNPT x FNPT	T-421	21.05	100/10
103-103NL	1/2"	FNPT x FNPT	T-421NL	26.86	100/10
103-104	3/4"	FNPT x FNPT	T-421	27.55	60/10
103-104NL	3/4"	FNPT x FNPT	T-421NL	35.16	60/10
103-105	1"	FNPT x FNPT	T-421	41.20	40/8
103-105NL	1"	FNPT x FNPT	T-421NL	52.59	40/8
103-106	1-1/4"	FNPT x FNPT	T-421	68.46	30/6
103-106NL	1-1/4"	FNPT x FNPT	T-421NL	87.49	30/6
103-107	1-1/2"	FNPT x FNPT	T-421	91.17	20/5
103-107NL	1-1/2"	FNPT x FNPT	T-421NL	115.37	20/5
103-108	2"	FNPT x FNPT	T-421	139.43	16/4
103-108NL	2"	FNPT x FNPT	T-421NL	171.00	16/4

Union Bonnet Bronze Globe Valve

300 CWP, 150 WSP, MSS SP-80
Rising stem



T-422

103-113	1/2"	FNPT x FNPT	T-422	48.39	80/8
103-114	3/4"	FNPT x FNPT	T-422	71.15	60/6
103-115	1"	FNPT x FNPT	T-422	102.99	36/6
103-116	1-1/4"	FNPT x FNPT	T-422	143.05	24/4
103-117	1-1/2"	FNPT x FNPT	T-422	213.73	16/4
103-118	2"	FNPT x FNPT	T-422	314.63	9/3

316 Stainless Steel Globe Valve

Naturally lead free
200 CWP, 125 WSP



T-752

113-473	1/2"	FNPT x FNPT	T-752	86.59	48/12
113-474	3/4"	FNPT x FNPT	T-752	104.11	48/12
113-475	1"	FNPT x FNPT	T-752	128.88	40/10
113-476	1-1/4"	FNPT x FNPT	T-752	176.60	24/6
113-477	1-1/2"	FNPT x FNPT	T-752	235.05	16/4
113-478	2"	FNPT x FNPT	T-752	290.95	8/2

CHECK VALVES

Brass Swing Check Valve

Traditional & no lead brass ISO 9002, 200 CWP
ANSI/NSF 372 (T/S-451NL)



T-451

105-101	1/4"	FNPT x FNPT	T-451	16.02	150/10
105-101NL	1/4"	FNPT x FNPT	T-451NL	23.46	150/10
105-102	3/8"	FNPT x FNPT	T-451	16.02	150/10
105-102NL	3/8"	FNPT x FNPT	T-451NL	23.46	150/10
105-103	1/2"	FNPT x FNPT	T-451	12.62	150/10
105-103NL	1/2"	FNPT x FNPT	T-451NL	19.66	150/10
105-104	3/4"	FNPT x FNPT	T-451	15.11	120/10
105-104NL	3/4"	FNPT x FNPT	T-451NL	24.17	120/10
105-105	1"	FNPT x FNPT	T-451	20.42	100/10
105-105NL	1"	FNPT x FNPT	T-451NL	33.25	100/10



CHECK VALVES

Brass Swing Check Valve (cont.)

Traditional & no lead brass ISO 9002, 200 CWP
ANSI/NSF 372 (T/S-451NL)



S-451

Part No.	Size	Configuration	Model No.	List Price	Cs/Ct
105-106	1-1/4"	FNPT x FNPT	T-451	31.96	50/5
105-106NL	1-1/4"	FNPT x FNPT	T-451NL	54.82	50/5
105-107	1-1/2"	FNPT x FNPT	T-451	45.09	30/5
105-107NL	1-1/2"	FNPT x FNPT	T-451NL	70.58	30/5
105-108	2"	FNPT x FNPT	T-451	70.92	24/2
105-108NL	2"	FNPT x FNPT	T-451NL	103.57	24/2
105-109	2-1/2"	FNPT x FNPT	T-451	135.94	10/1
105-109NL	2-1/2"	FNPT x FNPT	T-451NL	196.17	10/1
105-110	3"	FNPT x FNPT	T-451	180.82	8/1
105-110NL	3"	FNPT x FNPT	T-451NL	279.19	8/1
105-111	4"	FNPT x FNPT	T-451	302.67	6/1
105-111NL	4"	FNPT x FNPT	T-451NL	410.18	6/1
105-203	1/2"	Sweat x Sweat	S-451	12.62	150/10
105-203NL	1/2"	Sweat x Sweat	S-451NL	19.66	150/10
105-204	3/4"	Sweat x Sweat	S-451	15.11	120/10
105-204NL	3/4"	Sweat x Sweat	S-451NL	24.17	120/10
105-205	1"	Sweat x Sweat	S-451	20.42	50/5
105-205NL	1"	Sweat x Sweat	S-451NL	33.25	50/5
105-206	1-1/4"	Sweat x Sweat	S-451	31.96	50/5
105-206NL	1-1/4"	Sweat x Sweat	S-451NL	54.82	50/5
105-207	1-1/2"	Sweat x Sweat	S-451	45.09	30/5
105-207NL	1-1/2"	Sweat x Sweat	S-451NL	70.58	30/5
105-208	2"	Sweat x Sweat	S-451	70.92	24/2
105-208NL	2"	Sweat x Sweat	S-451NL	103.57	24/2
105-209	2-1/2"	Sweat x Sweat	S-451	168.43	10/1
105-209NL	2-1/2"	Sweat x Sweat	S-451NL	225.88	10/1
105-210	3"	Sweat x Sweat	S-451	251.75	8/2
105-210NL	3"	Sweat x Sweat	S-451NL	334.26	8/2

LegendPress™ Swing Check Valve

No lead DZR & forged brass
200 CWP
ANSI/NSF 61-G
ISO 9002



P-451NL

105-003NL	1/2"	Press x Press	P-451NL	30.38	150/25
105-004NL	3/4"	Press x Press	P-451NL	40.48	108/18
105-005NL	1"	Press x Press	P-451NL	57.60	72/12
105-006NL	1-1/4"	Press x Press	P-451NL	78.89	48/8
105-007NL	1-1/2"	Press x Press	P-451NL	109.75	36/6
105-008NL	2"	Press x Press	P-451NL	159.42	18/3

GATE, CHECK, LOW PRESSURE VALVES & STRAINERS

CHECK VALVES

Bronze Y-Pattern Check Valve

Traditional & no lead bronze
300 CWP, 150 WSP, MSS SP-80
ANSI/NSF 372 (T/S-453NL)
Conforms to MSS SP-80
ISO 9002
Max temp 365°F



T-453



S-453

Part No.	Size	Configuration	Model No.	List Price	Cs/Ct
105-303	1/2"	FNPT x FNPT	T-453	26.96	150/15
105-303NL	1/2"	FNPT x FNPT	T-453NL	35.35	150/15
105-304	3/4"	FNPT x FNPT	T-453	35.68	100/10
105-304NL	3/4"	FNPT x FNPT	T-453NL	46.22	100/10
105-305	1"	FNPT x FNPT	T-453	47.71	70/7
105-305NL	1"	FNPT x FNPT	T-453NL	62.76	70/7
105-306	1-1/4"	FNPT x FNPT	T-453	70.22	42/7
105-306NL	1-1/4"	FNPT x FNPT	T-453NL	90.99	42/7
105-307	1-1/2"	FNPT x FNPT	T-453	90.68	30/3
105-307NL	1-1/2"	FNPT x FNPT	T-453NL	118.94	30/3
105-308	2"	FNPT x FNPT	T-453	137.39	20/2
105-308NL	2"	FNPT x FNPT	T-453NL	180.23	20/2
105-403	1/2"	Sweat x Sweat	S-453	26.96	150/15
105-403NL	1/2"	Sweat x Sweat	S-453NL	35.35	150/15
105-404	3/4"	Sweat x Sweat	S-453	35.68	100/10
105-404NL	3/4"	Sweat x Sweat	S-453NL	46.22	100/10
105-405	1"	Sweat x Sweat	S-453	47.71	70/7
105-405NL	1"	Sweat x Sweat	S-453NL	62.76	70/7
105-406	1-1/4"	Sweat x Sweat	S-453	70.22	42/7
105-406NL	1-1/4"	Sweat x Sweat	S-453NL	90.99	42/7
105-407	1-1/2"	Sweat x Sweat	S-453	90.68	30/3
105-407NL	1-1/2"	Sweat x Sweat	S-453NL	118.94	30/3
105-408	2"	Sweat x Sweat	S-453	137.39	20/2
105-408NL	2"	Sweat x Sweat	S-453NL	180.23	20/2

In-line Bronze Check Valve

Traditional & no lead bronze
250 CWP, ISO 9002
Max temp 200°F @ 25 psi
ANSI/NSF 372 (T/S-455NL)



T-455

105-443	1/2"	FNPT x FNPT	T-455	25.42	224/28
105-443NL	1/2"	FNPT x FNPT	T-455NL	29.98	224/28
105-444	3/4"	FNPT x FNPT	T-455	33.08	144/18
105-444NL	3/4"	FNPT x FNPT	T-455NL	39.02	144/18
105-445	1"	FNPT x FNPT	T-455	45.79	72/18
105-445NL	1"	FNPT x FNPT	T-455NL	54.29	72/18
105-446	1-1/4"	FNPT x FNPT	T-455	58.16	48/12
105-446NL	1-1/4"	FNPT x FNPT	T-455NL	66.89	48/12
105-447	1-1/2"	FNPT x FNPT	T-455	81.28	32/8
105-447NL	1-1/2"	FNPT x FNPT	T-455NL	93.47	32/8
105-448	2"	FNPT x FNPT	T-455	115.90	24/6
105-448NL	2"	FNPT x FNPT	T-455NL	137.81	24/6

GATE, CHECK, LOW PRESSURE VALVES & Y-STRAINERS



CHECK VALVES

In-line Bronze Check Valve (cont.)

Traditional & no lead bronze
250 CWP
Max temp 200°F @ 25 psi
ANSI/NSF 372 (T/S-455 NL)
ISO 9002



S-455

No lead bronze
200 CWP
ANSI/NSF 372
Max temp 200°F
ISO 9002



T-450NL

Part No.	Size	Configuration	Model No.	List Price	Cs/Ct
105-463	1/2"	Sweat x Sweat	S-455	25.42	204/34
105-463NL	1/2"	Sweat x Sweat	S-455NL	29.98	204/34
105-464	3/4"	Sweat x Sweat	S-455	33.08	120/40
105-464NL	3/4"	Sweat x Sweat	S-455NL	39.02	120/40
105-465	1"	Sweat x Sweat	S-455	45.79	72/18
105-465NL	1"	Sweat x Sweat	S-455NL	54.29	72/18
105-466	1-1/4"	Sweat x Sweat	S-455	58.16	48/12
105-466NL	1-1/4"	Sweat x Sweat	S-455NL	66.89	48/12
105-467	1-1/2"	Sweat x Sweat	S-455	81.28	36/12
105-467NL	1-1/2"	Sweat x Sweat	S-455NL	93.47	36/12
105-468	2"	Sweat x Sweat	S-455	115.90	24/12
105-468NL	2"	Sweat x Sweat	S-455NL	137.81	24/12

105-423NL	1/2"	FNPT x FNPT	T-450NL	15.64	80/1
105-424NL	3/4"	FNPT x FNPT	T-450NL	20.76	60/1
105-425NL	1"	FNPT x FNPT	T-450NL	24.07	48/1
105-426NL	1-1/4"	FNPT x FNPT	T-450NL	38.64	36/1
105-427NL	1-1/2"	FNPT x FNPT	T-450NL	53.05	24/1
105-428NL	2"	FNPT x FNPT	T-450NL	107.75	12/1
105-430NL	3"	FNPT x FNPT	T-450NL	307.75	4/1
105-431NL	4"	FNPT x FNPT	T-450NL	695.89	2/1

GATE, CHECK, LOW PRESSURE VALVES & STRAINERS

Did you know? Legend ships every order in 24 hours, guaranteed or you get 5% off the order.

STAINLESS STEEL CHECK VALVES

316 Stainless Steel Check Valve

600 CWP, 125 WSP
Naturally lead free



Part No.	Size	Configuration	Model No.	List Price	Cs/Ct
113-433	1/2"	FNPT x FNPT	T-750	89.23	100/25
113-434	3/4"	FNPT x FNPT	T-750	105.84	80/20
113-435	1"	FNPT x FNPT	T-750	130.10	60/15
113-436	1-1/4"	FNPT x FNPT	T-750	170.83	40/10
113-437	1-1/2"	FNPT x FNPT	T-750	218.24	24/6
113-438	2"	FNPT x FNPT	T-750	285.45	16/4

304 Stainless Steel In-Line Check Valve

200 CWP, 125 WSP
Naturally lead free



113-455	1"	FNPT x FNPT	T-755	26.29	60/10
113-456	1-1/4"	FNPT x FNPT	T-755	44.16	40/5

FOOT VALVES

Bronze Foot Valve

No lead bronze
ISO 9002, 250 CWP
ANSI/NSF 372



105-474NL	3/4"	FNPT	T-448NL	24.43	100/1
105-475NL	1"	FNPT	T-448NL	33.77	100/1
105-476NL	1-1/4"	FNPT	T-448NL	49.77	50/1
105-477NL	1-1/2"	FNPT	T-448NL	68.57	40/1
105-478NL	2"	FNPT	T-448NL	119.41	20/1

304 Stainless Steel Foot Valve

250 CWP
Naturally lead free



113-465	1"	FNPT	T-756	49.94	60/10
113-466	1-1/4"	FNPT	T-756	68.35	40/5

Y-STRAINERS

Bronze Y-Strainer

Traditional & no lead bronze
300 CWP, 150 WSP
ANSI/NSF 372 (T/S-15NL)
20 mesh 304 stainless steel screen
Square head closure plug included



105-501	1/4"	FNPT x FNPT	T-15	27.37	60/12
105-501NL	1/4"	FNPT x FNPT	T-15NL	30.59	60/12
105-502	3/8"	FNPT x FNPT	T-15	27.37	60/12
105-502NL	3/8"	FNPT x FNPT	T-15NL	30.59	60/12
105-503	1/2"	FNPT x FNPT	T-15	27.37	60/12
105-503NL	1/2"	FNPT x FNPT	T-15NL	35.23	60/12
105-504	3/4"	FNPT x FNPT	T-15	38.55	48/8
105-504NL	3/4"	FNPT x FNPT	T-15NL	51.31	48/8
105-505	1"	FNPT x FNPT	T-15	58.14	32/8
105-505NL	1"	FNPT x FNPT	T-15NL	75.14	32/8
105-506	1-1/4"	FNPT x FNPT	T-15	87.94	32/8
105-506NL	1-1/4"	FNPT x FNPT	T-15NL	113.56	32/8
105-507	1-1/2"	FNPT x FNPT	T-15	117.15	16/2
105-507NL	1-1/2"	FNPT x FNPT	T-15NL	151.38	16/2



Y-STRAINERS

Bronze Y-Strainer (cont.)

Traditional & no lead bronze
300 CWP, 150 WSP
ANSI/NSF 372 (T/S-15NL)
20 mesh 304 stainless steel screen (1/4" - 2")
Square head closure plug included

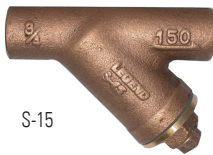

S-15

Part No.	Size	Configuration	Model No.	List Price	Cs/Ct
105-508	2"	FNPT x FNPT	T-15	180.74	8/2
105-508NL	2"	FNPT x FNPT	T-15NL	233.91	8/2

2-1/2" & 3" With 304 Stainless Steel 1/16" Perforated Strainer

105-509	2-1/2"	FNPT x FNPT	T-15	302.07	6/1
105-509NL	2-1/2"	FNPT x FNPT	T-15NL	395.21	6/1
105-510	3"	FNPT x FNPT	T-15	445.52	4/1
105-510NL	3"	FNPT x FNPT	T-15NL	580.50	4/1

105-513	1/2"	Sweat x Sweat	S-15	27.37	60/10
105-513NL	1/2"	Sweat x Sweat	S-15NL	35.23	60/10
105-514	3/4"	Sweat x Sweat	S-15	38.55	48/8
105-514NL	3/4"	Sweat x Sweat	S-15NL	51.31	48/8
105-515	1"	Sweat x Sweat	S-15	58.14	32/8
105-515NL	1"	Sweat x Sweat	S-15NL	75.14	32/8
105-516	1-1/4"	Sweat x Sweat	S-15	87.94	32/8
105-516NL	1-1/4"	Sweat x Sweat	S-15NL	113.56	32/8
105-517	1-1/2"	Sweat x Sweat	S-15	117.15	16/2
105-517NL	1-1/2"	Sweat x Sweat	S-15NL	151.38	16/2
105-518	2"	Sweat x Sweat	S-15	180.74	8/2
105-518NL	2"	Sweat x Sweat	S-15NL	233.91	8/2

2-1/2" & 3" With 304 Stainless Steel 1/16" Perforated Strainer

105-519	2-1/2"	Sweat x Sweat	S-15	302.07	6/1
105-519NL	2-1/2"	Sweat x Sweat	S-15NL	395.21	6/1
105-520	3"	Sweat x Sweat	S-15	445.52	4/1
105-520NL	3"	Sweat x Sweat	S-15NL	580.50	4/1

Compact Y-Strainer

Traditional & no lead brass
300 CWP, 150 WSP
ANSI/NSF 372 (T/S-16NL)
20 mesh 304 stainless steel screen
No closure plug
ISO 9002



T-16

105-703	1/2"	FNPT x FNPT	T-16	11.50	48/12
105-703NL	1/2"	FNPT x FNPT	T-16NL	14.27	48/12
105-704	3/4"	FNPT x FNPT	T-16	20.12	48/8
105-704NL	3/4"	FNPT x FNPT	T-16NL	26.06	48/8
105-705	1"	FNPT x FNPT	T-16	29.09	32/8
105-705NL	1"	FNPT x FNPT	T-16NL	36.95	32/8
105-706	1-1/4"	FNPT x FNPT	T-16	42.44	24/6
105-706NL	1-1/4"	FNPT x FNPT	T-16NL	52.31	24/6
105-707	1-1/2"	FNPT x FNPT	T-16	54.65	16/2
105-707NL	1-1/2"	FNPT x FNPT	T-16NL	71.98	16/2
105-708	2"	FNPT x FNPT	T-16	87.95	8/2
105-708NL	2"	FNPT x FNPT	T-16NL	115.85	8/2

Y-STRAINERS

Compact Bronze Y-Strainer (cont.)

Traditional & no lead brass

300 CWP, 150 WSP

ANSI/NSF 372 (T/S-16NL)

20 mesh 304 stainless steel screen

No closure plug

ISO 9002



Part No.	Size	Configuration	Model No.	List Price	Cs/Ct
2-1/2" & 3" With 304 Stainless Steel 1/16" Perforated Strainer					
105-709	2-1/2"	FNPT x FNPT	T-16	236.84	1-Aug
105-709NL	2-1/2"	FNPT x FNPT	T-16NL	311.94	1-Aug
105-710	3"	FNPT x FNPT	T-16	302.83	1-Jun
105-710NL	3"	FNPT x FNPT	T-16NL	494.65	1-Jun

Y-Strainers Screen

304 stainless steel

20 Mesh Stainless Steel Screen

900-090	1/4" - 1/2"	Fits T/S-15	20 Mesh SS	3.91	- / -
900-091	3/4"	Fits T/S-15	20 Mesh SS	4.26	- / -
900-092	1"	Fits T/S-15	20 Mesh SS	5.04	- / -
900-093	1-1/4"	Fits T/S-15	20 Mesh SS	6.75	- / -
900-094	1-1/2"	Fits T/S-15	20 Mesh SS	8.84	- / -
900-095	2"	Fits T/S-15	20 Mesh SS	11.34	- / -



20 Mesh stainless steel screen

1/16" Perforated Stainless Steel Strainer

900-096	2-1/2"	Fits T/S-15	1/16" Perforated SS	17.42	- / -
900-097	3"	Fits T/S-15	1/16" Perforated SS	20.63	- / -

40 Mesh Stainless Steel Screen

105-533	1/4" - 1/2"	Fits T/S-15	40 Mesh SS	4.05	- / -
105-534	3/4"	Fits T/S-15	40 Mesh SS	4.40	- / -
105-535	1"	Fits T/S-15	40 Mesh SS	5.24	- / -
105-536	1-1/4"	Fits T/S-15	40 Mesh SS	7.02	- / -
105-537	1-1/2"	Fits T/S-15	40 Mesh SS	9.18	- / -
105-538	2"	Fits T/S-15	40 Mesh SS	11.79	- / -

80 Mesh Stainless Steel Screen

105-543	1/4" - 1/2"	Fits T/S-15	80 Mesh SS	4.13	- / -
105-544	3/4"	Fits T/S-15	80 Mesh SS	4.49	- / -
105-545	1"	Fits T/S-15	80 Mesh SS	5.35	- / -
105-546	1-1/4"	Fits T/S-15	80 Mesh SS	7.17	- / -
105-547	1-1/2"	Fits T/S-15	80 Mesh SS	9.38	- / -
105-548	2"	Fits T/S-15	80 Mesh SS	12.03	- / -



T/S-15 Screen

20 Mesh Stainless Steel Screen

105-733	1/2"	Fits T-16	20 Mesh SS	2.05	- / -
105-734	3/4"	Fits T-16	20 Mesh SS	2.63	- / -
105-735	1"	Fits T-16	20 Mesh SS	3.08	- / -
105-736	1-1/4"	Fits T-16	20 Mesh SS	4.60	- / -
105-737	1-1/2"	Fits T-16	20 Mesh SS	6.16	- / -
105-738	2"	Fits T-16	20 Mesh SS	7.75	- / -



Y-STRAINERS

Y-Strainers Screen (cont.)

304 stainless steel



Part No.	Size	Configuration	Model No.	List Price	Cs/Ct
1/16" Perforated Stainless Steel Strainer					
105-719	2-1/2"	Fits T-16	1/16" Perforated SS	17.88	- / -
105-720	3"	Fits T-16	1/16" Perforated SS	25.56	- / -
40 Mesh Stainless Steel Screen					
105-713	1/2"	Fits T-16	40 Mesh SS	2.15	- / -
105-714	3/4"	Fits T-16	40 Mesh SS	2.77	- / -
105-715	1"	Fits T-16	40 Mesh SS	3.25	- / -
105-716	1-1/4"	Fits T-16	40 Mesh SS	4.81	- / -
105-717	1-1/2"	Fits T-16	40 Mesh SS	6.44	- / -
105-718	2"	Fits T-16	40 Mesh SS	8.13	- / -
80 Mesh Stainless Steel Screen					
105-723	1/2"	Fits T-16	80 Mesh SS	2.15	- / -
105-724	3/4"	Fits T-16	80 Mesh SS	2.77	- / -
105-725	1"	Fits T-16	80 Mesh SS	3.25	- / -
105-726	1-1/4"	Fits T-16	80 Mesh SS	4.81	- / -
105-727	1-1/2"	Fits T-16	80 Mesh SS	6.44	- / -
105-728	2"	Fits T-16	80 Mesh SS	8.13	- / -

Cast Iron Y- Strainer

ISO 9002, 500 CWP, 250 WSP to 310°F
20 mesh 304 stainless steel screen (1/4" - 2")
304 stainless steel 1/16" round perforated strainer
(2-1/2" - 3")
Naturally lead free
Square head closure plug included



T-17

105-521	1/4"	FNPT x FNPT	T-17	14.79	10/1
105-522	3/8"	FNPT x FNPT	T-17	15.99	24/1
105-523	1/2"	FNPT x FNPT	T-17	16.43	24/1
105-524	3/4"	FNPT x FNPT	T-17	24.95	12/1
105-525	1"	FNPT x FNPT	T-17	32.78	10/1
105-526	1-1/4"	FNPT x FNPT	T-17	52.69	12/1
105-527	1-1/2"	FNPT x FNPT	T-17	66.34	10/1
105-528	2"	FNPT x FNPT	T-17	96.70	5/1
105-529	2-1/2"	FNPT x FNPT	T-17	245.56	1/1
105-530	3"	FNPT x FNPT	T-17	272.98	1/1

Flanged Cast Iron Y- Strainer

200 CWP, 125 WSP to 340° F
Naturally lead free
Square head closure plug included



T-19

With 1/16" Perforated 304 Stainless Steel Strainer

105-611	2"	Flanged	T-19	169.54	- / -
105-612	2-1/2"	Flanged	T-19	209.30	- / -
105-613	3"	Flanged	T-19	259.31	- / -
105-614	4"	Flanged	T-19	389.79	- / -

With 1/8" Perforated 304 Stainless Steel Strainer

105-615	5"	Flanged	T-19	589.99	- / -
105-616	6"	Flanged	T-19	859.00	- / -
105-617	8"	Flanged	T-19	1175.00	- / -

Due to the large freight cost, the flanged Y-Strainers are classified as Cast Iron for freight minimum.

Y-STRAINERS

316 Stainless Steel Y-Strainer

600 CWP, 150 WSP
Naturally lead free
Stainless steel closure plug included

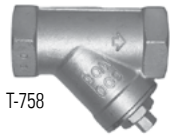

T-758

Part No.	Size	Configuration	Model No.	List Price	Cs/Ct
With 1/16" perforated 304 stainless steel strainer					
113-493	1/2"	FNPT x FNPT	T-758	62.65	80/20
113-494	3/4"	FNPT x FNPT	T-758	78.18	60/15
113-495	1"	FNPT x FNPT	T-758	102.76	48/12
113-496	1-1/4"	FNPT x FNPT	T-758	136.56	32/8
113-497	1-1/2"	FNPT x FNPT	T-758	177.19	24/6
113-498	2"	FNPT x FNPT	T-758	228.65	6/1

FROSTFREE SILLCOCKS

1/4 Turn Frostfree Sillcock, Patented Design

Traditional & no lead brass
125 CWP
ISO 9002, ASSE 1019A Certified
1/4 turn Softouch™ handle, patented
with integrated anti-siphon, brass cap
ANSI/NSF 61G



1/2" T-550 is Combination 1/2" MNPT and 1/2" Sweat

108-153A	1/2" x 8"	MNPT / Sweat	T-550	49.78	20/1
108-153NL	1/2" x 8"	MNPT / Sweat	T-550NL	55.95	20/1
108-154A	1/2" x 10"	MNPT / Sweat	T-550	52.74	20/1
108-154NL	1/2" x 10"	MNPT / Sweat	T-550NL	60.15	20/1
108-155A	1/2" x 12"	MNPT / Sweat	T-550	55.58	20/1
108-155NL	1/2" x 12"	MNPT / Sweat	T-550NL	62.27	20/1
108-156A	1/2" x 14"	MNPT / Sweat	T-550	60.29	20/1
108-156NL	1/2" x 14"	MNPT / Sweat	T-550NL	65.56	20/1



T-550 MNPT/Sweat

108-003A	1/2" x 8"	PEX (F 1807)	T-550P	49.78	20/1
NEW 108-003NL	1/2" x 8"	PEX (F 1807)	T-550PNL	53.42	20/1
108-004A	1/2" x 10"	PEX (F 1807)	T-550P	52.74	20/1
NEW 108-004NL	1/2" x 10"	PEX (F 1807)	T-550PNL	57.06	20/1
108-005A	1/2" x 12"	PEX (F 1807)	T-550P	55.58	20/1
NEW 108-005NL	1/2" x 12"	PEX (F 1807)	T-550PNL	59.06	20/1
108-006A	1/2" x 14"	PEX (F 1807)	T-550P	60.29	20/1
NEW 108-006NL	1/2" x 14"	PEX (F 1807)	T-550PNL	62.26	20/1



T-550 PEX

108-173A	1/2" x 8"	CPVC	T-550CPVC	52.40	20/1
108-174A	1/2" x 10"	CPVC	T-550CPVC	55.52	20/1
108-175A	1/2" x 12"	CPVC	T-550CPVC	58.51	20/1



T-550CPVC

3/4" T-550 is Combination 3/4" MNPT and 1/2" FNPT

108-158A	3/4" x 8"	MNPT / FNPT	T-550	52.75	20/1
108-158NL	3/4" x 8"	MNPT / FNPT	T-550NL	60.10	20/1
108-159A	3/4" x 10"	MNPT / FNPT	T-550	53.95	20/1
108-159NL	3/4" x 10"	MNPT / FNPT	T-550NL	61.82	20/1
108-160A	3/4" x 12"	MNPT / FNPT	T-550	59.94	20/1
108-160NL	3/4" x 12"	MNPT / FNPT	T-550NL	64.04	20/1



T-550 MNPT/FNPT

3/4" T-550 is Combination 3/4" MNPT and 3/4" Sweat

108-166A	3/4" x 8"	MNPT / Sweat	T-550	52.75	20/1
108-167A	3/4" x 10"	MNPT / Sweat	T-550	54.82	20/1
108-168A	3/4" x 12"	MNPT / Sweat	T-550	59.80	20/1
108-169A	3/4" x 14"	MNPT / Sweat	T-550	61.62	20/1



T-550 Sweat

GATE, CHECK, LOW PRESSURE VALVES & Y-STRAINERS

FROSTFREE SILLCOCKS

T-550 Replacement Parts



T-550 Cartridge & stem

Part No.	Size	Configuration	Model No.	List Price	Cs/Ct
Handle, Screw & Disc					
108-162		Handle, Screw & Disc	T-550 & T-550NL	9.69	- / -
T-550 Cartridge & Stem					
108-904A	4"	Cartridge & Stem	T-550 & T-550NL	23.59	- / -
108-906A	6"	Cartridge & Stem	T-550 & T-550NL	24.04	- / -
108-908A	8"	Cartridge & Stem	T-550 & T-550NL	24.48	- / -
108-910A	10"	Cartridge & Stem	T-550 & T-550NL	24.94	- / -
108-912A	12"	Cartridge & Stem	T-550 & T-550NL	25.38	- / -
108-914A	14"	Cartridge & Stem	T-550 & T-550NL	25.88	- / -

T-552 Close Coupled Sillcock

Multi-turn with integrated anti-siphon and Softouch™ handle



T-552

108-120	1/2" x 2-7/8"	MNPT x Sweat	T-552	31.43	20/1
---------	---------------	--------------	-------	-------	------

TM-550 Multi-Turn Frostfree Sillcock

Traditional & no lead brass
ISO 9002, 125 CWP
ASSE 1019 certified
ANSI / NSF 61-G (NL models)
Multi-turn Softouch™ handle,
patented with integrated
anti-siphon, brass cap



TM-550 MNPT/Sweat

1/2" TM-550 is Combination 1/2" MNPT and 1/2" Sweat

NEW	108-021	1/2" x 4"	MNPT / Sweat	TM-550	33.72	20/1
NEW	108-021NL	1/2" x 4"	MNPT / Sweat	TM-550NL	43.06	20/1
NEW	108-022	1/2" x 6"	MNPT / Sweat	TM-550	35.44	20/1
NEW	108-022NL	1/2" x 6"	MNPT / Sweat	TM-550NL	45.28	20/1
NEW	108-023	1/2" x 8"	MNPT / Sweat	TM-550	37.22	20/1
NEW	108-023NL	1/2" x 8"	MNPT / Sweat	TM-550NL	47.44	20/1
NEW	108-024	1/2" x 10"	MNPT / Sweat	TM-550	38.83	20/1
NEW	108-024NL	1/2" x 10"	MNPT / Sweat	TM-550NL	49.56	20/1
NEW	108-025	1/2" x 12"	MNPT / Sweat	TM-550	41.36	20/1
NEW	108-025NL	1/2" x 12"	MNPT / Sweat	TM-550NL	52.75	20/1
NEW	108-026	1/2" x 14"	MNPT / Sweat	TM-550	43.03	20/1
NEW	108-026NL	1/2" x 14"	MNPT / Sweat	TM-550NL	54.92	20/1

3/4" TM-550 is Combination 3/4" MNPT and 1/2" FNPT

NEW	108-027	3/4" x 4"	MNPT / FNPT	TM-550	35.22	20
NEW	108-027NL	3/4" x 4"	MNPT / FNPT	TM-550NL	45.00	20
NEW	108-028	3/4" x 6"	MNPT / FNPT	TM-550	36.89	20
NEW	108-028NL	3/4" x 6"	MNPT / FNPT	TM-550NL	47.11	20
NEW	108-029	3/4" x 8"	MNPT / FNPT	TM-550	38.67	20
NEW	108-029NL	3/4" x 8"	MNPT / FNPT	TM-550NL	49.39	20
NEW	108-030	3/4" x 10"	MNPT / FNPT	TM-550	39.89	20
NEW	108-030NL	3/4" x 10"	MNPT / FNPT	TM-550NL	50.89	20
NEW	108-031	3/4" x 12"	MNPT / FNPT	TM-550	42.83	20
NEW	108-031NL	3/4" x 12"	MNPT / FNPT	TM-550NL	54.64	20
NEW	108-032	3/4" x 14"	MNPT / FNPT	TM-550	44.56	20
NEW	108-032NL	3/4" x 14"	MNPT / FNPT	TM-550NL	56.86	20



TM-550 MNPT/FNPT

FROSTFREE SILLCOCKS

TM-550 Multi-Turn Frostfree Sillcock (cont.)

Traditional & no lead brass
ISO 9002, 125 CWP
ASSE 1019 certified
ANSI/NSF 61-G (NL models)
Multi-turn Softouch™ handle,
patented with integrated
anti-siphon, brass cap



TM-550PNL

3/4" TM-550 is Combination 3/4" MNPT and 1/2" FNPT

Part No.	Size	Configuration	Model No.	List Price	Cs/Ct
NEW 108-033	1/2" x 4"	PEX	TM-550P	32.80	20
NEW 108-033NL	1/2" x 4"	PEX	TM-550PNL	41.86	20
NEW 108-034	1/2" x 6"	PEX	TM-550P	34.48	20
NEW 108-034NL	1/2" x 6"	PEX	TM-550PNL	44.00	20
NEW 108-035	1/2" x 8"	PEX	TM-550P	36.21	20
NEW 108-035NL	1/2" x 8"	PEX	TM-550PNL	46.14	20
NEW 108-036	1/2" x 10"	PEX	TM-550P	37.79	20
NEW 108-036NL	1/2" x 10"	PEX	TM-550PNL	48.23	20
NEW 108-037	1/2" x 12"	PEX	TM-550P	38.96	20
NEW 108-037NL	1/2" x 12"	PEX	TM-550PNL	49.78	20
NEW 108-038	1/2" x 14"	PEX	TM-550P	40.59	20
NEW 108-038NL	1/2" x 14"	PEX	TM-550PNL	51.86	20

TM-550P1960 Mutli-Turn Frostfree Faucet

Traditional & no lead brass
125 CWP, ASTM F 1960 Cold Expansion
PEX Inlet
ANSI/NSF 61-G (NL models)
Multi-turn Softouch™ handle, patented
with integrated anti-siphon, brass cap



TM-550P1960 PEX

NEW 108-041	1/2" x 4"	1960 PEX	TM-550P1960	46.65	20/1
NEW 108-041NL	1/2" x 4"	1960 PEX	TM-550PNL1960	53.00	20/1
NEW 108-042	1/2" x 6"	1960 PEX	TM-550P1960	48.07	20/1
NEW 108-042NL	1/2" x 6"	1960 PEX	TM-550PNL1960	54.62	20/1
NEW 108-043	1/2" x 8"	1960 PEX	TM-550P1960	49.48	20/1
NEW 108-043NL	1/2" x 8"	1960 PEX	TM-550PNL1960	56.23	20/1
NEW 108-044	1/2" x 10"	1960 PEX	TM-550P1960	52.85	20/1
NEW 108-044NL	1/2" x 10"	1960 PEX	TM-550PNL1960	60.06	20/1
NEW 108-045	1/2" x 12"	1960 PEX	TM-550P1960	54.71	20/1
NEW 108-045NL	1/2" x 12"	1960 PEX	TM-550PNL1960	62.17	20/1
NEW 108-046	1/2" x 14"	1960 PEX	TM-550P1960	57.68	20/1
NEW 108-046NL	1/2" x 14"	1960 PEX	TM-550PNL1960	65.54	20/1

TM-550 Replacement Part

ANSI/NSF 61-G



TM-550 Brass Assembly & Spring

Seat Washer, Brass Cup Assembly & Spring

NEW 108-550	TM-550	1.92	200/1
NEW 108-550NL	TM-550NL	2.08	200/1

TM-550, TM550 Repair Kit



Seat Washer, Brass Cup Assembly & Spring Vacuum breaker repair kit for T-550 & TM-550

108-903	T-550 / TM-550	3.53	-/-
---------	----------------	------	-----

GATE, CHECK, LOW PRESSURE VALVES & Y-STRAINERS

FROSTFREE SILLCOCKS

T-552 Multi-Turn Frostfree Sillcock

Traditional & no lead brass
ISO 9002, 125 CWP
ASSE 1019A Certified
CSA Certified (Canada)
ANSI / NSF 61-G (NL models)
with integrated anti-siphon
Third party certified Truesdail



T-552



T-552 MNPT/FNPT



T-552 PEX

Part No.	Size	Configuration	Model No.	List Price	Cs/Ct
1/2" T-552 is Combination 1/2" MNPT and 1/2" Sweat					
108-121	1/2" x 4"	MNPT / Sweat	T-552	29.90	40/10
108-121NL	1/2" x 4"	MNPT / Sweat	T-552NL	31.98	40/10
108-122	1/2" x 6"	MNPT / Sweat	T-552	31.12	40/10
108-122NL	1/2" x 6"	MNPT / Sweat	T-552NL	33.14	40/10
108-123	1/2" x 8"	MNPT / Sweat	T-552	31.58	40/10
108-123NL	1/2" x 8"	MNPT / Sweat	T-552NL	34.35	40/10
108-124	1/2" x 10"	MNPT / Sweat	T-552	33.51	40/10
108-124NL	1/2" x 10"	MNPT / Sweat	T-552NL	35.76	40/10
108-125	1/2" x 12"	MNPT / Sweat	T-552	34.66	40/10
108-125NL	1/2" x 12"	MNPT / Sweat	T-552NL	36.96	40/10
108-126	1/2" x 14"	MNPT / Sweat	T-552	35.97	40/10
108-126NL	1/2" x 14"	MNPT / Sweat	T-552NL	38.32	40/10

3/4" T-552 is Combination 3/4" MNPT and 1/2" FNPT

108-133	3/4" x 8"	MNPT / FNPT	T-552	33.43	40/10
108-133NL	3/4" x 8"	MNPT / FNPT	T-552NL	37.51	40/10
108-134	3/4" x 10"	MNPT / FNPT	T-552	34.48	40/10
108-134NL	3/4" x 10"	MNPT / FNPT	T-552NL	38.92	40/10
108-135	3/4" x 12"	MNPT / FNPT	T-552	35.75	40/10
108-135NL	3/4" x 12"	MNPT / FNPT	T-552NL	40.18	40/10

108-141	1/2" x 4"	PEX (F 1807)	T-552P	28.76	40/10
108-141NL	1/2" x 4"	PEX (F 1807)	T-552PNL	33.18	40/10
108-142	1/2" x 6"	PEX (F 1807)	T-552P	30.00	40/10
108-142NL	1/2" x 6"	PEX (F 1807)	T-552PNL	35.10	40/10
108-143	1/2" x 8"	PEX (F 1807)	T-552P	31.04	40/10
108-143NL	1/2" x 8"	PEX (F 1807)	T-552PNL	35.81	40/10
108-144	1/2" x 10"	PEX (F 1807)	T-552P	32.23	40/10
108-144NL	1/2" x 10"	PEX (F 1807)	T-552PNL	37.08	40/10
108-145	1/2" x 12"	PEX (F 1807)	T-552P	33.20	40/10
108-145NL	1/2" x 12"	PEX (F 1807)	T-552PNL	37.53	40/10
108-146	1/2" x 14"	PEX (F 1807)	T-552P	32.80	40/10
108-146NL	1/2" x 14"	PEX (F 1807)	T-552PNL	40.25	40/10

T-552 Repair Accessories



Stem Repair Kit



Vacuum Breaker Repair Kit

Vacuum Breaker Repair Kit

108-138	VB Repair Kit	T-552 & T-552NL	3.34	- / -
---------	---------------	-----------------	------	-------

Stem Repair Kit

108-139	Stem Repair Kit	T-552 & T-552NL	5.02	- / -
---------	-----------------	-----------------	------	-------

FROSTFREE SILLCOCKS

T-551 Standard Multi-Turn Frostfree Sillcock

Traditional & no lead brass
ISO 9002, 125 CWP



T-551



T-551

Part No.	Size	Configuration	Model No.	List Price	Cs/Ct
1/2" T-551 is Combination 1/2" MNPT and 1/2" Sweat					
108-101	1/2" x 4"	MNPT / Sweat	T-551	22.11	60/2
108-101NL	1/2" x 4"	MNPT / Sweat	T-551NL	24.57	60/2
108-102	1/2" x 6"	MNPT / Sweat	T-551	22.60	60/2
108-102NL	1/2" x 6"	MNPT / Sweat	T-551NL	25.11	60/2
108-103	1/2" x 8"	MNPT / Sweat	T-551	23.90	60/2
108-103NL	1/2" x 8"	MNPT / Sweat	T-551NL	26.55	60/2
108-104	1/2" x 10"	MNPT / Sweat	T-551	25.48	60/2
108-104NL	1/2" x 10"	MNPT / Sweat	T-551NL	28.31	60/2
108-105	1/2" x 12"	MNPT / Sweat	T-551	26.16	60/2
108-105NL	1/2" x 12"	MNPT / Sweat	T-551NL	29.07	60/2
108-106	1/2" x 14"	MNPT / Sweat	T-551	27.94	60/2
108-106NL	1/2" x 14"	MNPT / Sweat	T-551NL	31.04	60/2

3/4" T-551 is Combination 3/4" MNPT and 1/2" FNPT

108-113	3/4" x 8"	MNPT / FNPT	T-551	25.43	60/2
108-113NL	3/4" x 8"	MNPT / FNPT	T-551NL	28.26	60/2
108-114	3/4" x 10"	MNPT / FNPT	T-551	27.30	60/2
108-114NL	3/4" x 10"	MNPT / FNPT	T-551NL	30.33	60/2
108-115	3/4" x 12"	MNPT / FNPT	T-551	28.70	60/2
108-115NL	3/4" x 12"	MNPT / FNPT	T-551NL	31.89	60/2

1/4 TURN PLUMBING VALVES

1/4 Turn Ball Valve Boiler Drain

Traditional & no lead forged brass
ISO 9002, 200 CWP
ANSI/NSF 61-G (NL only)



R-670



R-672

Boiler Drain Valve

1/2" R-670 & R-670NL is Combination 1/2" MNPT and 1/2" Sweat

107-543	1/2"	MNPT	R-670	10.80	100/10
107-543NL	1/2"	MNPT	R-670NL	13.74	100/10
107-544	3/4"	MNPT	R-670	12.69	100/10
107-544NL	3/4"	MNPT	R-670NL	16.14	100/10

Boiler Drain Valve

107-554	1/2"	FNPT	R-672	12.46	100/10
107-554NL	1/2"	FNPT	R-672NL	16.16	100/10
107-555	3/4"	FNPT	R-672	13.07	100/10
107-555NL	3/4"	FNPT	R-672NL	18.12	100/10

1/4 Turn Ball Valve Sillcock

Traditional & no lead forged brass
CSA Certified USA and Canada
ISO 9002, 200 CWP
ANSI/NSF 61-G (NL only)



R-673NL

Sillcock

107-574	1/2"	FNPT	R-673	13.18	100/10
107-574NL	1/2"	FNPT	R-673NL	16.35	100/10
107-575	3/4"	FNPT	R-673	15.81	100/10
107-575NL	3/4"	FNPT	R-673NL	19.11	100/10

Sillcock

107-584	1/2"	Sweat	R-674	14.51	100/10
107-584NL	1/2"	Sweat	R-674NL	17.64	100/10



1/4 TURN PLUMBING VALVES

1/4 Turn Ball Valve Sillcock (cont.)

Traditional & no lead forged brass
CSA Certified USA and Canada
ISO 9002, 200 CWP
ANSI/NSF 61-G (NL only)



R-674NL

Part No.	Size	Configuration	Model No.	List Price	Cs/Ct
107-585	3/4"	Sweat	R-674	15.74	100/10
107-585NL	3/4"	Sweat	R-674NL	20.21	100/10

1/4 Turn No Kink Hose Bibb

Traditional & no lead forged brass
ISO 9002, 200 CWP
ANSI / NSF 61-G (NL only)



R-671

No Kink Hose Bibb

1/2" R-671 is Combination 1/2" MNPT and 1/2" Sweat

107-567	1/2"	MNPT	R-671	12.49	100/10
107-567NL	1/2"	MNPT	R-671NL	16.35	100/10
107-568	3/4"	MNPT	R-671	13.29	100/10
107-568NL	3/4"	MNPT	R-671NL	17.41	100/10

1/4 Turn Ball Valve Hose Bibb

Traditional & no lead forged brass
ISO 9002, 200 CWP
ANSI/NSF 61-G (NL only)



T-537NL

Ball Valve Hose Bibb

1/2" T-537, T-537L & T-540 is Combination 1/2" MNPT and 1/2" Sweat

107-167	1/2"	MNPT	T-537	12.18	100/10
107-167NL	1/2"	MNPT	T-537NL	15.48	100/10
107-168	3/4"	MNPT	T-537	15.36	100/10
107-168NL	3/4"	MNPT	T-537NL	19.44	100/10



T-537L

Lever Handle

Ball Valve Hose Bibb

1/2" T-537, T-537L & T-540 is Combination 1/2" MNPT and 1/2" Sweat

107-162	1/2"	MNPT	T-537L	12.18	100/10
107-162NL	1/2"	MNPT	T-537LNL	15.48	100/10
107-163	3/4"	MNPT	T-537L	15.36	100/10
107-163NL	3/4"	MNPT	T-537LNL	19.44	100/10



T-540

Water Heater Drain Valve

107-169	3/4"	MNPT	T-540	15.78	100/10
107-169NL	3/4"	MNPT	T-540NL	19.44	100/10

1/4 Turn Ball Valve Flanged Sillcock

Forged brass
125 CWP
ISO 9002



T-541FLG

S-541FLG

Lever Handle

107-464	1/2"	FNPT	T-541FLG	11.51	72/12
107-465	3/4"	FNPT	T-541FLG	12.26	72/12
107-474	1/2"	Sweat	S-541FLG	11.51	72/12
107-475	3/4"	Sweat	S-541FLG	12.26	72/12

1/4 TURN PLUMBING VALVES

1/4 Turn Ball Valve Flanged Sillcock, Chrome Plated

Forged brass
125 CW/P



T-541CFL

NEW

NEW

NEW

NEW

Part No.	Size	Configuration	Model No.	List Price	Cs/Ct
107-464CP	1/2"	FNPT	T-541CFL	14.67	72/12
107-465CP	3/4"	FNPT	T-541CFL	15.89	72/12
107-474CP	1/2"	Solder	S-541CFL	14.67	72/12
107-475CP	3/4"	Solder	S-541CFL	15.89	72/12

T-547RB Commercial Ball Valve Sillcock

125 psi max temp 180°F
ASSE 1011, CSA B62.2.2 (Canada)
ISO 9002



T-547RB

NEW

NEW

Quarter-turn, includes a Softouch™ handle and loose key

107-431	1/2"	FNPT x MGHT	T-547RB	35.66	24/1
107-432	3/4"	FNPT x MGHT	T-547RB	36.66	24/1

T-548 Satin Commercial Ball Type Sillcock

125 psi max temp 180°F
ASSE 1011, CSA B62.2.2 (Canada)
ISO 9002



T-548

NEW

NEW

Quarter-turn, includes a Softouch™ handle and loose key

107-441	1/2"	FNPT x MGHT	T-548	36.62	24/1
107-442	3/4"	FNPT x MGHT	T-548	37.62	24/1

T-549CP Commercial Ball Type Sillcock

125 psi max temp 180°F
ASSE 1011, CSA B62.2.2
ISO 9002



T-549CP

NEW

NEW

Quarter-turn, includes a Softouch™ handle and loose key

107-451	1/2"	FNPT x MGHT	T-549CP	38.23	24/1
107-452	3/4"	FNPT x MGHT	T-549CP	39.23	24/1

Did you know? Legend ships every order complete or you will receive 5% off the backorder.

LOW PRESSURE PLUMBING VALVES

Stop Valves

Traditional & no lead brass
ISO 9002, 125 CWP
ANSI/NSF 61-G (NL only)
Third party certified Truesdail



S-501NL



T-501NL



T-501X



S-501PNL



Part No.	Size	Configuration	Model No.	List Price	Cs/Ct
107-103NL	1/2"	FNPT x FNPT	T-501NL	10.54	100/10
107-104NL	3/4"	FNPT x FNPT	T-501NL	12.89	100/10
107-113NL	1/2"	Sweat x Sweat	S-501NL	8.71	100/10
107-114NL	3/4"	Sweat x Sweat	S-501NL	11.42	100/10
107-106	1/2"	FNPT x FNPT	T-501X	10.44	144/12
107-107	3/4"	FNPT x FNPT	T-501X	10.54	144/12
107-110NL	1/2"	PEX x PEX	S-501PNL	14.03	100/10
107-111NL	3/4"	PEX x PEX	S-501PNL	19.11	100/10

Long Bonnet Stop Valve

Traditional & no lead brass
ISO 9002, 125 CWP
ANSI/NSF 61-G (NL only)
15 WSP (T/S 505 only)
Third party certified Truesdail



T-505



S-504



S-505

Straight

107-253	1/2"	FNPT x FNPT	T-504	13.30	100/10
107-253NL	1/2"	FNPT x FNPT	T-504NL	17.09	100/10
107-255	1/2"	Sweat x Sweat	S-504	12.56	100/10
107-255NL	1/2"	Sweat x Sweat	S-504NL	16.53	100/10
107-256	3/4"	Sweat x Sweat	S-504	15.18	72/6
107-256NL	3/4"	Sweat x Sweat	S-504NL	17.86	72/6

Angle

107-257	1/2"	FNPT x FNPT	T-505	14.05	100/10
107-257NL	1/2"	FNPT x FNPT	T-505NL	17.73	100/10
107-259	1/2"	Sweat x Sweat	S-505	14.50	100/10
107-259NL	1/2"	Sweat x Sweat	S-505NL	17.03	100/10

Angle Stop Valve

No lead brass
ISO 9002, 125 CWP
ANSI/NSF 61-G
Third party certified Truesdail

S-503NL



T-503NL

107-116NL	1/2"	FNPT x FNPT	T-503NL	14.18	100/10
107-117NL	3/4"	FNPT x FNPT	T-503NL	16.35	100/10
107-118NL	1/2"	Sweat x Sweat	S-503NL	11.48	100/10
107-119NL	3/4"	Sweat x Sweat	S-503NL	14.39	100/10

LOW PRESSURE PLUMBING VALVES

Stop and Waste Valve

No lead brass
ISO 9002, 125 CWP
ANSI/NSF 61-G
Third party certified Truesdail



S-511NL



T-511NL

S-511PNL



T-512NL

Part No.	Size	Configuration	Model No.	List Price	Cs/Ct
107-123NL	1/2"	FNPT x FNPT	T-511NL	12.20	100/10
107-124NL	3/4"	FNPT x FNPT	T-511NL	14.68	100/10
107-133NL	1/2"	Sweat x Sweat	S-511NL	9.07	100/10
107-134NL	3/4"	Sweat x Sweat	S-511NL	11.62	100/10
107-316NL	1/2"	Comp x Comp	T-512NL	17.94	100/10
107-317NL	3/4"	Comp x Comp	T-512NL	21.55	100/10
107-130NL	1/2"	PEX x PEX	S-511PNL	15.42	100/10
107-131NL	3/4"	PEX x PEX	S-511PNL	20.90	100/10

Boiler Drain

Traditional & no lead brass
ISO 9002, 125 CWP
ANSI/NSF 61-G (NL only)
CSA (Canada)
Third party certified Truesdail



T-521



S-524



T-522



T-523NL



S-521P



T-206

1/2" Male T-521 is Combination 1/2" MNPT and 1/2" Sweat

107-143	1/2"	MNPT	T-521	6.64	100/10
107-143NL	1/2"	MNPT	T-521NL	9.30	100/10
107-144	3/4"	MNPT	T-521	7.67	100/10
107-144NL	3/4"	MNPT	T-521NL	10.33	100/10
107-146	3/4"	Sweat	S-521	8.86	144/12
107-146NL	3/4"	Sweat	S-521NL	11.67	144/12
107-154	1/2"	FNPT	T-522	7.72	100/10
107-154NL	1/2"	FNPT	T-522NL	9.64	100/10
107-155	3/4"	FNPT	T-522	8.50	100/10
107-155NL	3/4"	FNPT	T-522NL	11.19	100/10
107-148	1/2"	Fitting	S-524	10.25	100/12
107-148NL	1/2"	Fitting	S-524NL	11.06	100/12
107-157NL	1/2"	Compression	T-523NL	19.35	100/10
107-159	1/2"	PEX	S-521P	10.46	100/10
107-159NL	1/2"	PEX	S-521PNL	13.80	100/10

No Stuffing Box

107-327	1/2"	MNPT	T-206	6.25	144/12
107-327NL	1/2"	MNPT	T-206NL	7.23	144/12
107-328	3/4"	MNPT	T-206	6.25	144/12
107-328NL	3/4"	MNPT	T-206NL	8.22	144/12

GATE, CHECK, LOW PRESSURE VALVES & Y-STRAINERS



LOW PRESSURE PLUMBING VALVES

Hose Bibb

Traditional & no lead brass
ISO 9002, 125 CWP
ANSI/NSF 61-G (NL only)
Third party certified Truesdail



T-531



T-532



T-532CP



T-534



T-533



S-535

Part No.	Size	Configuration	Model No.	List Price	Cs/Ct
1/2" Male T-531 is Combination 1/2" MNPT and 1/2" Sweat					
107-164	1/2"	MNPT	T-531	6.56	100/10
107-164NL	1/2"	MNPT	T-531NL	8.28	100/10
107-165	3/4"	MNPT	T-531	7.61	100/10
107-165NL	3/4"	MNPT	T-531NL	9.78	100/10

Plain End Sampling Valve

1/2" Male T-532 is Combination 1/2" MNPT and 1/2" Sweat

107-173	1/2"	MNPT	T-532	8.79	144/12
107-173NL	1/2"	MNPT	T-532NL	11.02	144/12
107-171	3/4"	MNPT	T-532	10.74	144/12
107-171NL	3/4"	MNPT	T-532NL	13.43	144/12

Chrome Plated Plain End Valve

1/2" Male T-532CP is Combination 1/2" MNPT and 1/2" Sweat

107-423	1/2"	MNPT	T-532CP	14.20	144/12
107-423NL	1/2"	MNPT	T-532CPNL	17.29	144/12
107-424	3/4"	MNPT	T-532CP	15.75	144/12
107-424NL	3/4"	MNPT	T-532CPNL	19.67	144/12

No Kink

1/2" Male T-533 is Combination 1/2" MNPT and 1/2" Sweat

107-203	1/2"	MNPT	T-533	8.54	144/12
107-203NL	1/2"	MNPT	T-533NL	9.78	144/12
107-204	3/4"	MNPT	T-533	8.95	144/12
107-204NL	3/4"	MNPT	T-533NL	11.18	144/12
107-213	1/2"	FNPT	T-534	7.35	144/12
107-213NL	1/2"	FNPT	T-534NL	9.19	144/12
107-214	3/4"	FNPT	T-534	8.59	144/12
107-214NL	3/4"	FNPT	T-534NL	10.54	144/12

S-535 is Combination 3/4" Fitting and 1/2" Sweat

107-223	3/4" / 1/2"	FTG / Sweat	S-535	8.83	144/12
107-223NL	3/4" / 1/2"	FTG / Sweat	S-535NL	11.36	144/12

LOW PRESSURE PLUMBING VALVES

Heavy Pattern Hose Bibb

Traditional & no lead brass
ISO 9002, 125 CWP
ANSI/NSF 61-G (NL only)



T-531HP



T-533HP



T-534HP

Third party certified Truesdail



T-536HP



S-535HP

Part No.	Size	Configuration	Model No.	List Price	Cs/Ct
1/2" Male T-531HP is Combination 1/2" MNPT and 1/2" Sweat					
107-263	1/2"	MNPT	T-531HP	13.85	72/12
107-263NL	1/2"	MNPT	T-531HPNL	17.09	72/12
107-264	3/4"	MNPT	T-531HP	15.01	72/12
107-264NL	3/4"	MNPT	T-531HPNL	18.74	72/12
107-265	1"	MNPT	T-531HP	40.03	72/12
107-265NL	1"	MNPT	T-531HPNL	49.99	72/12
No Kink					
107-267	1/2"	MNPT	T-533HP	11.99	72/12
107-267NL	1/2"	MNPT	T-533HPNL	14.82	72/12
107-268	3/4"	MNPT	T-533HP	12.85	72/12
107-268NL	3/4"	MNPT	T-533HPNL	15.19	72/12
107-270	1/2"	FNPT	T-534HP	11.73	72/12
107-270NL	1/2"	FNPT	T-534HPNL	13.88	72/12
107-271	3/4"	FNPT	T-534HP	13.05	72/12
107-271NL	3/4"	FNPT	T-534HPNL	15.75	72/12
S-535HP is Combination 3/4" Fitting and 1/2" Sweat					
107-275	3/4" / 1/2"	FTG / Sweat	S-535HP	9.41	100/10
107-275NL	3/4" / 1/2"	FTG / Sweat	S-535HPNL	12.89	100/10
107-277	1/2"	Compression	T-536HP	11.81	100/10
107-277NL	1/2"	Compression	T-536HPNL	14.75	100/10

Did you know? Legend guarantees error-free transactions or you will receive 5% off the error.

GATE, CHECK, LOW PRESSURE VALVES & Y-STRAINERS

LOW PRESSURE PLUMBING VALVES

Sillcock

Traditional & no lead brass
ISO 9002, 125 CWP
CSA (Canada) no lead only
ANSI/NSF 61-G (NL only)



S-541



T-541LS

S-211



S-541P

Part No.	Size	Configuration	Model No.	List Price	Cs/Ct
107-174	1/2"	FNPT	T-541	8.54	100/10
107-174NL	1/2"	FNPT	T-541NL	11.31	100/10
107-175	3/4"	FNPT	T-541	10.99	100/10
107-175NL	3/4"	FNPT	T-541NL	13.86	100/10
107-184	1/2"	Sweat	S-541	8.15	100/10
107-184NL	1/2"	Sweat	S-541NL	10.92	100/10
107-185	3/4"	Sweat	S-541	10.67	100/10
107-185NL	3/4"	Sweat	S-541NL	13.32	100/10

With Lockshield

107-187	1/2"	FNPT	T-541LS	17.03	100/10
107-187NL	1/2"	FNPT	T-541LSNL	20.89	100/10
107-188	3/4"	FNPT	T-541LS	18.93	100/10
107-188NL	3/4"	FNPT	T-541LSNL	23.36	100/10
107-189	1/2"	Sweat	S-541LS	16.85	100/10
107-189NL	1/2"	Sweat	S-541LSNL	21.04	100/10

S-211 is Combination 3/4" Fitting and 1/2" Sweat

107-347	3/4" / 1/2"	FTG / Sweat	S-211	8.72	144/12
107-347NL	3/4" / 1/2"	FTG / Sweat	S-211NL	10.96	144/12

107-183	1/2"	PEX	S-541P	11.17	100/10
107-183NL	1/2"	PEX	S-541PNL	14.25	100/10

Commercial Sillcock, Chrome Plated

Traditional & no lead brass
ISO 9002, 125 CWP
CSA (Canada) no lead only
ANSI/NSF 61-G (NL only)



T-545



T-546



KEY



T-545VB

107-403	1/2"	FNPT	T-545	26.60	144/12
107-403NL	1/2"	FNPT	T-545NL	31.35	144/12
107-404	3/4"	FNPT	T-545	28.74	144/12
107-404NL	3/4"	FNPT	T-545NL	34.92	144/12

With Lockshield

107-407	1/2"	FNPT	T-546	30.90	144/12
107-407NL	1/2"	FNPT	T-546NL	36.95	144/12
107-408	3/4"	FNPT	T-546	30.74	144/12
107-408NL	3/4"	FNPT	T-546NL	37.99	144/12

Key only for T-546

107-410		Key for T-546		2.63	- / -
---------	--	---------------	--	------	-------

With Assembled Chrome Plated Vacuum Breaker

107-413	1/2"	FNPT	T-545VB	41.80	144/12
107-413NL	1/2"	FNPT	T-545VBNL	52.40	144/12
107-414	3/4"	FNPT	T-545VB	43.15	144/12
107-414NL	3/4"	FNPT	T-545VBNL	51.34	144/12

GATE, CHECK, LOW PRESSURE VALVES & STRAINERS

LOW PRESSURE PLUMBING VALVES

Commercial Sillcock, Chrome Plated (cont.)

Traditional & no lead brass
ISO 9002, 125 CWP
CSA (Canada) no lead only
ANSI/NSF 61-G (NL only)



T-546VB

Part No.	Size	Configuration	Model No.	List Price	Cs/Ct
With Lockshield & Assembled Chrome Plated Vacuum Breaker					
107-417	1/2"	FNPT	T-546VB	42.75	144/12
107-417NL	1/2"	FNPT	T-546VBNL	48.79	144/12
107-418	3/4"	FNPT	T-546VB	45.07	144/12
107-418NL	3/4"	FNPT	T-546VBNL	53.29	144/12

Bent Nose Garden Valve

Traditional & no lead brass
ISO 9002, 125 CWP
ANSI/NSF 61-G (NL only)
Third party certified Truesdail



T-543



T-544

107-243	1/2"	FNPT	T-543	10.50	100/10
107-243NL	1/2"	FNPT	T-543NL	12.82	100/10
107-244	3/4"	FNPT	T-543	11.13	72/12
107-244NL	3/4"	FNPT	T-543NL	13.21	72/12
107-245	1"	FNPT	T-543	11.87	72/12
107-245NL	1"	FNPT	T-543NL	14.08	72/12
Inverted					
107-246	3/4"	FNPT	T-544	12.67	144/12
107-246NL	3/4"	FNPT	T-544NL	15.82	144/12

Water Heater Drain Valve

Traditional & no lead brass
ISO 9002, 125 CWP
NSF 372 (NL)



T-539

107-192	3/4"	MNPT	T-539	16.14	144/12
107-192NL	3/4"	MNPT	T-539NL	19.50	144/12

SUPPLY STOPS - 1/4 TURN

INSTA-LOC™ 1/4 Turn Push-Fit CP Supply Stop

No lead forged brass
ISO 9002, 125 CWP, max temp 120°
ANSI/NSF 61-G
Third party certified Truesdail



T-596NL



T-595NL

Angle Valves					
114-903NL	1/2" x 3/8"	Push x OD	T-595NL	14.41	120/5
114-904NL	1/2" x 1/4"	Push x OD	T-595NL	14.61	120/5
Straight Valves					
114-913NL	1/2" x 3/8"	Push x OD	T-596NL	14.41	120/5
114-914NL	1/2" x 1/4"	Push x OD	T-596NL	14.61	120/5

1/4 Turn Angle Valve

No lead forged brass
ISO 9002, 125 CWP
ANSI/NSF 61-G
Third party certified Truesdail



FNPT x OD
T-595NL

NEW

OD x OD
T-595NL

114-602NL	3/8" x 3/8"	FNPT x OD	T-595NL	8.31	120/5
114-603NL	1/2" x 3/8"	FNPT x OD	T-595NL	8.56	120/5
114-604NL	5/8" x 3/8"	OD x OD	T-595NL	9.78	120/5
114-607NL	1/2" x 3/8"	CPVC x OD	T-595NL	12.24	120/5
114-609NL	1/2" x 3/8"	PEX x OD	T-595NL	8.81	120/5
114-606NL	1/2" x 3/8"	PEX (F 1960) x OD	T-595NL	8.90	120/5
114-613NL	1/2" x 3/8"	Sweat x OD	T-595NL	9.00	120/5



GATE, CHECK, LOW PRESSURE VALVES & Y-STRAINERS

SUPPLY STOPS - 1/4 TURN

1/4 Turn Angle Valve (cont.)

No lead forged brass
ISO 9002, 125 CWP
ANSI/NSF 61-G
Third party
certified Truesdail



NEW

Part No.	Size	Configuration	Model No.	List Price	Cs/Ct
Icemaker Valve					
114-614NL	5/8" x 1/4"	OD x OD	T-595NL	11.56	120/5
114-615NL	1/2" x 1/4"	PEX x OD	T-595NL	9.41	120/5
114-605NL	1/2" x 1/4"	PEX (F 1960) x OD	T-595NL	8.90	120/5
Polished Brass					
114-624NL	5/8" x 3/8"	OD x OD	T-595PBNL	25.22	120/5
Slip Joint Outlet 1/2" Or 7/16" OD					
114-653NL	1/2"	FNPT x SJ	T-593NL	12.31	120/5
114-654NL	5/8"	OD x SJ	T-593NL	14.31	120/5

1/4 Turn Straight Valve

No lead forged brass
ISO 9002, 125 CWP, max temp 120°F
ANSI/NSF 61-G
Third party certified Truesdail



NEW

NEW

NEW

114-702NL	3/8" x 3/8"	FNPT x OD	T-596NL	8.56	120/5
114-703NL	1/2" x 3/8"	FNPT x OD	T-596NL	10.32	120/5
114-704NL	5/8" x 3/8"	OD x OD	T-596NL	9.41	120/5
114-707NL	1/2" x 3/8"	CPVC x OD	T-596NL	12.06	120/5
114-709NL	1/2" x 3/8"	PEX x OD	T-596NL	8.63	120/5
114-710NL	1/2" x 1/2"	PEX x PEX	T-596NL	11.65	120/5
114-706NL	1/2" x 3/8"	PEX (F 1960) x OD	T-596NL	8.90	120/5
114-713NL	1/2" x 3/8"	Sweat x OD	T-596NL	8.57	120/5
Icemaker Valve					
114-714NL	5/8" x 1/4"	OD x OD	T-596NL	11.56	120/5
114-715NL	1/2" x 1/4"	PEX x OD	T-596NL	9.41	120/5
114-705NL	1/2" x 1/4"	PEX (F 1960) x OD	T-596NL	8.90	120/5
Polished Brass					
114-724NL	5/8" x 3/8"	OD x OD	T-596PBNL	31.50	120/5
Slip Joint Outlet 1/2" Or 7/16" OD					
114-753NL	1/2"	FNPT x SJ	T-594NL	10.62	120/5
114-754NL	5/8"	OD x SJ	T-594NL	13.46	120/5

1/4 Turn Dual Outlet Valve

No lead forged brass
ISO 9002, 125 CWP, max temp 120°F
ANSI/NSF 61-G
Third party certified Truesdail



NEW

NEW

NEW

NEW

114-803NL	1/2" x 3/8" x 3/8"	FNPT x OD x OD	T-597NL	14.07	120/5
114-804NL	5/8" x 3/8" x 3/8"	OD x OD x OD	T-597NL	16.31	120/5
114-823NL	1/2" x 3/8" x 1/4"	FNPT x OD x OD	T-597NL	13.94	120/5
114-824NL	5/8" x 3/8" x 1/4"	OD x OD x OD	T-597NL	16.18	120/5
114-805NL	1/2" x 3/8" x 1/4"	PEX x OD x OD	T-597NL	11.24	120/5
114-806NL	1/2" x 3/8" x 3/8"	PEX x OD x OD	T-597NL	11.24	120/5
114-801NL	1/2" x 3/8" x 1/4"	PEX (F 1960) x OD x OD	T-597NL	12.57	120/5
114-802NL	1/2" x 3/8" x 3/8"	PEX (F 1960) x OD x OD	T-597NL	12.57	120/5

GATE, CHECK, LOW PRESSURE VALVES & STRAINERS

SUPPLY STOPS - TRADITIONAL STYLE

Multi-Turn Angle Valve

No lead forged brass
ISO 9002, 110 CWP
ANSI/NSF 61-G



OD x OD
T-581NL



PEX x OD
T-581PNL



CPVC x OD
T-581NL



Sweat x OD
S-581ETNL



OD x OD
T-581PBNL



OD x OD
T-581RBNL



OD x SJ
T-583NL



Sweat x OD
S-581LSNL

Part No.	Size	Configuration	Model No.	List Price	Cs/Ct
114-101NL	3/8" x 3/8"	OD x OD	T-581NL (CR-1B)	7.80	200/10
114-102NL	3/8" x 3/8"	FNPT x OD	T-581NL (R-15)	6.45	200/10
114-103NL	1/2" x 3/8"	FNPT x OD	T-581NL (R-17)	7.36	200/10
114-104NL	5/8" x 3/8"	OD x OD	T-581NL (CR-19)	8.14	200/10
114-107NL	1/2" x 3/8"	CPVC x OD	T-581NL (PR-19)	9.94	200/10

114-113NL	1/2" x 3/8"	Sweat x OD	S-581NL (R-19)	6.70	200/10
114-109NL	1/2" x 3/8"	PEX x OD	T-581PNL	7.83	200/10

Icemaker Valve

114-116NL	5/8" x 1/4"	OD x OD	T-581NL (CR-09)	7.89	200/10
-----------	-------------	---------	-----------------	------	--------

With 5" Extension Tube & Bell Escutcheon

114-115NL	1/2" x 3/8"	Sweat x OD	S-581ETNL (CS-40B)	13.13	100/1
-----------	-------------	------------	--------------------	-------	-------

Rough Brass Stops

114-153NL	1/2" x 3/8"	FNPT x OD	T-581RBNL (R-17R)	6.77	200/10
114-154NL	5/8" x 3/8"	OD x OD	T-581RBNL (CR19R)	7.48	200/10
114-163NL	1/2" x 3/8"	Sweat x OD	T-581RBNL (R19R)	7.36	200/10

Polished Brass

114-304NL	5/8" x 3/8"	OD x OD	T-581PBNL	18.40	200/10
-----------	-------------	---------	-----------	-------	--------

114-123NL	1/2" x 1/2"	FNPT x OD	T-581NL (R-37)	8.88	200/10
114-124NL	5/8" x 1/2"	OD x OD (CR-39)	T-581NL (R-39)	10.13	200/10

114-126NL	1/2" x 1/2"	Sweat x OD	S-581NL (R-39)	9.24	200/10
-----------	-------------	------------	----------------	------	--------

Slip Joint Outlet 1/2" or 7/16" OD

114-133NL	1/2"	FNPT x SJ	T-583NL	9.28	200/10
114-134NL	5/8"	OD x SJ	T-583NL (3341)	11.28	200/10
114-136NL	1/2"	Sweat x SJ	S-583NL (3321)	10.47	200/10

With Lockshield

114-143NL	1/2" x 3/8"	FNPT x OD	T-581LSNL	10.07	200/10
114-144NL	5/8" x 3/8"	OD x OD	T-581LSNL	10.87	200/10

114-146NL	1/2" x 3/8"	Sweat x OD	S-581LSNL	9.60	200/10
-----------	-------------	------------	-----------	------	--------

GATE, CHECK, LOW PRESSURE VALVES & Y-STRAINERS



SUPPLY STOPS - TRADITIONAL STYLE

Multi-Turn Straight Valves

No lead forged brass
ISO 9002, 110 CWP
ANSI/NSF 61-G



PEX x OD
T-591PNL



CPVC x OD
T-582NL



Sweat x OD
S-582ETNL



OD x OD
T-582NL

FNPT x SJ
T-584NL



Part No.	Size	Configuration	Model No.	List Price	Cs/Ct
114-200NL	1/4" x 1/4"	OD x OD	T-582NL	8.15	200/10
114-201NL	3/8" x 3/8"	OD x OD	T-582NL (CR-11)	8.59	200/10
114-202NL	3/8" x 3/8"	FNPT x OD	T-582NL (R-10)	8.22	200/10
114-203NL	1/2" x 3/8"	FNPT x OD	T-582NL (R-12)	9.08	200/10
114-204NL	5/8" x 3/8"	OD x OD	T-582NL (CR-14)	9.49	200/10
114-207NL	1/2" x 3/8"	CPVC x OD	T-582NL (PR-14)	11.09	200/10
114-209NL	1/2" x 3/8"	PEX x OD	T-582PNL	8.16	200/10
114-513NL	1/2" x 1/2"	PEX x PEX	T-591PNL	8.11	200/10

114-213NL	1/2" x 3/8"	Sweat x OD	S-582NL (R-14)	9.03	200/10
-----------	-------------	------------	----------------	------	--------

With 5" Extension Tube & Bell Escutcheon

114-215NL	1/2" x 3/8"	Sweat x OD	S-582ETNL (CS-41B)	12.55	100/1
-----------	-------------	------------	--------------------	-------	-------

114-231NL	1/2" x 1/2"	OD x OD	T-582NL (CR-3A)	9.94	200/10
-----------	-------------	---------	-----------------	------	--------

114-233NL	1/2" x 1/2"	FNPT x OD	T-582NL (CR-3C)	9.84	200/10
-----------	-------------	-----------	-----------------	------	--------

114-234NL	5/8" x 1/2"	OD x OD	T-582NL (CR-34)	10.33	200/10
-----------	-------------	---------	-----------------	-------	--------

114-236NL	1/2" x 1/2"	Sweat x OD	S-582NL (R-34)	10.10	200/10
-----------	-------------	------------	----------------	-------	--------

Slip Joint Outlet 1/2" Or 7/16" OD

114-253NL	1/2"	FNPT x SJ	T-584NL (3305)	10.23	200/10
-----------	------	-----------	----------------	-------	--------

114-254NL	5/8"	OD x SJ	T-584NL (3345)	10.62	200/10
-----------	------	---------	----------------	-------	--------

114-256NL	1/2"	Sweat x SJ	S-584NL (3321)	10.14	200/10
-----------	------	------------	----------------	-------	--------

Multi-Turn Dual Outlet Valve

Traditional & no lead forged brass
ISO 9002, 110 CWP
ANSI/NSF 61-G



FNPT x OD x OD
T-587NL



OD x OD x OD
T-587NL

114-402NL	3/8" x 3/8" x 3/8"	FNPT x OD x OD	T-587NL (R1501)	9.70	200/10
-----------	--------------------	----------------	-----------------	------	--------

114-403NL	1/2" x 3/8" x 3/8"	FNPT x OD x OD	T-587NL (R1701)	9.52	200/10
-----------	--------------------	----------------	-----------------	------	--------

114-404NL	5/8" x 3/8" x 3/8"	OD x OD x OD	T-587NL (CR1901)	10.39	200/10
-----------	--------------------	--------------	------------------	-------	--------

114-413NL	1/2" x 3/8" x 1/2"	FNPT x OD x OD	T-587NL (R1703R)	10.83	200/10
-----------	--------------------	----------------	------------------	-------	--------

114-423NL	1/2" x 3/8" x 1/4"	FNPT x OD x OD	T-587NL (R1700)	9.34	200/10
-----------	--------------------	----------------	-----------------	------	--------

114-424NL	5/8" x 3/8" x 1/4"	OD x OD x OD	T-587NL (CR1900)	10.18	200/10
-----------	--------------------	--------------	------------------	-------	--------

114-406NL	1/2" x 3/8" x 3/8"	PEX x OD x OD	T-587PNL	8.84	200/10
-----------	--------------------	---------------	----------	------	--------

GATE, CHECK, LOW PRESSURE VALVES & STRAINERS

PVC BUTTERFLY VALVES

Wafer Type PVC Butterfly Valve

ISO 9002
150 psi @ 73°F w/ EPDM seat and O-rings
Naturally lead free



Part No.	Size	Configuration	Model No.	List Price	Cs/Ct
7- Position Lever Handle					
201-263	2"	Flanged	S-650	171.88	4/2
201-264	2-1/2"	Flanged	S-650	176.86	4/2
201-265	3"	Flanged	S-650	192.32	4/2
201-266	4"	Flanged	S-650	224.00	4/2
201-268	6"	Flanged	S-650	364.01	4/2
201-269	8"	Flanged	S-650	665.75	- / -
Gear Operator					
201-270	8"	Flanged	S-651	842.10	- / -
201-271	10"	Flanged	S-651	989.79	- / -
201-272	12"	Flanged	S-651	1363.71	- / -

PVC BALL VALVE

Grey PVC Flanged True Union Ball Valve

ISO 9002, 150 psi @ 73°F
Naturally lead free



201-233	1/2"	Flanged	S-643	31.80	24/1
201-234	3/4"	Flanged	S-643	30.90	24/1
201-235	1"	Flanged	S-643	49.97	12/1
201-236	1-1/4"	Flanged	S-643	68.83	12/1
201-237	1-1/2"	Flanged	S-643	88.80	12/1
201-238	2"	Flanged	S-643	105.00	12/1
201-239	2-1/2"	Flanged	S-643	189.00	4/1
201-240	3"	Flanged	S-643	265.13	2/1
201-241	4"	Flanged	S-643	490.26	- / -

Grey PVC True Union Ball Valve

ISO 9002, 150 psi @ 73°F
With both solvent and threaded adapters (1/2" - 2")
Naturally lead free



201-203	1/2"	FNPT / Solvent	T/S-603	13.31	48/1
201-204	3/4"	FNPT / Solvent	T/S-603	16.64	36/1
201-205	1"	FNPT / Solvent	T/S-603	23.72	24/1
201-206	1-1/4"	FNPT / Solvent	T/S-603	32.14	24/1
201-207	1-1/2"	FNPT / Solvent	T/S-603	44.96	24/1
201-208	2"	FNPT / Solvent	T/S-603	61.43	12/1

With solvents Ends Only

201-209	2-1/2"	Solvent	S-603	105.73	12/1
201-210	3"	Solvent	S-603	162.35	6/1
201-211	4"	Solvent	S-603	337.23	- / -

FNPT Adapters

201-229	Fits 2-1/2"	FNPT	S-603	12.99	- / -
201-230	Fits 3"	FNPT	S-603	22.00	- / -
201-231	Fits 4"	FNPT	S-603	41.95	- / -

Threaded Adapters Not Sold as Pairs



PVC BALL VALVES

Grey PVC True Union Ball Valve (cont.)

ISO 9002, 150 psi @ 73°F
With both solvent and threaded adapters (1/2" - 2")
Naturally lead free



Part No.	Size	Configuration	Model No.	List Price	Cs/Ct
With Both End Adapters - Viton O-Rings Design					
201-183	1/2"	FNPT / Solvent	T/S-603V	16.99	36/1
201-184	3/4"	FNPT / Solvent	T/S-603V	23.24	36/1
201-185	1"	FNPT / Solvent	T/S-603V	33.58	24/1
201-186	1-1/4"	FNPT / Solvent	T/S-603V	43.76	24/1
201-187	1-1/2"	FNPT / Solvent	T/S-603V	60.83	24/1
201-188	2"	FNPT / Solvent	T/S-603V	87.03	12/1

Grey PVC Single Union Ball Valve

ISO 9002, 150 CWP
Naturally lead free



201-243	1/2"	FNPT x FNPT	T-645	13.34	48/1
201-244	3/4"	FNPT x FNPT	T-645	15.43	36/1
201-245	1"	FNPT x FNPT	T-645	19.52	24/1
201-246	1-1/4"	FNPT x FNPT	T-645	31.65	24/1
201-247	1-1/2"	FNPT x FNPT	T-645	40.52	24/1
201-248	2"	FNPT x FNPT	T-645	53.79	12/1
201-253	1/2"	Solvent x Solvent	S-645	13.34	48/1
201-254	3/4"	Solvent x Solvent	S-645	15.43	36/1
201-255	1"	Solvent x Solvent	S-645	19.52	24/1
201-256	1-1/4"	Solvent x Solvent	S-645	31.65	24/1
201-257	1-1/2"	Solvent x Solvent	S-645	40.52	24/1
201-258	2"	Solvent x Solvent	S-645	54.89	12/1

Grey PVC Compact Ball Valve

ISO 9002, 150 psi @ 73°F
NSF Listed
Teflon seats, for schedule 80 use
Naturally lead free



201-423	1/2"	FNPT x FNPT	T-602	6.26	100/1
201-424	3/4"	FNPT x FNPT	T-602	7.69	100/1
201-425	1"	FNPT x FNPT	T-602	11.43	100/1
201-426	1-1/4"	FNPT x FNPT	T-602	14.95	100/1
201-427	1-1/2"	FNPT x FNPT	T-602	24.48	48/1
201-428	2"	FNPT x FNPT	T-602	31.03	24/1
201-433	1/2"	Solvent x Solvent	S-602	6.26	100/1
201-434	3/4"	Solvent x Solvent	S-602	7.69	100/1
201-435	1"	Solvent x Solvent	S-602	11.43	100/1
201-436	1-1/4"	Solvent x Solvent	S-602	14.95	100/1
201-437	1-1/2"	Solvent x Solvent	S-602	24.48	48/1
201-438	2"	Solvent x Solvent	S-602	31.03	24/1

Two-Piece E-Z Turn Valves



201-439	2-1/2"	Solvent x Solvent	S-602EZ	84.04	12/1
201-440	3"	Solvent x Solvent	S-602EZ	109.78	8/1
201-441	4"	Solvent x Solvent	S-602EZ	215.40	2/1

PVC BALL VALVES

PVC Compact Ball Valve

ISO 9002, 150 psi @ 73°F
NSF Listed (T/S-600)
With EPDM seats, fits schedule 40 or 80 pipe
Naturally lead free



Part No.	Size	Configuration	Model No.	List Price	Cs/Ct
201-443	1/2"	FNPT x FNPT	T-600	3.26	100/1
201-444	3/4"	FNPT x FNPT	T-600	3.99	100/1
201-445	1"	FNPT x FNPT	T-600	5.49	100/1
201-446	1-1/4"	FNPT x FNPT	T-600	7.58	100/1
201-447	1-1/2"	FNPT x FNPT	T-600	11.89	48/1
201-448	2"	FNPT x FNPT	T-600	15.91	24/1
201-453	1/2"	Solvent x Solvent	S-600	3.26	100/1
201-454	3/4"	Solvent x Solvent	S-600	3.99	100/1
201-455	1"	Solvent x Solvent	S-600	5.49	100/1
201-456	1-1/4"	Solvent x Solvent	S-600	7.58	100/1
201-457	1-1/2"	Solvent x Solvent	S-600	11.89	48/1
201-458	2"	Solvent x Solvent	S-600	15.91	24/1
201-301	1/4"	FNPT x FNPT	T-601	6.65	200/20
201-303	1/2"	FNPT x FNPT	T-601	2.46	100/1
201-304	3/4"	FNPT x FNPT	T-601	3.16	100/1
201-305	1"	FNPT x FNPT	T-601	4.71	100/1
201-306	1-1/4"	FNPT x FNPT	T-601	6.54	100/1
201-307	1-1/2"	FNPT x FNPT	T-601	9.29	48/1
201-308	2"	FNPT x FNPT	T-601	13.87	24/1
201-309	2-1/2"	FNPT x FNPT	T-601	42.07	12/1
201-310	3"	FNPT x FNPT	T-601	70.12	12/1
201-311	4"	FNPT x FNPT	T-601	118.04	6/1
201-403	1/2"	Solvent x Solvent	S-601	2.46	100/1
201-404	3/4"	Solvent x Solvent	S-601	3.16	100/1
201-405	1"	Solvent x Solvent	S-601	4.71	100/1
201-406	1-1/4"	Solvent x Solvent	S-601	6.54	100/1
201-407	1-1/2"	Solvent x Solvent	S-601	9.29	48/1
201-408	2"	Solvent x Solvent	S-601	13.87	24/1
201-409	2-1/2"	Solvent x Solvent	S-601	42.07	12/1
201-410	3"	Solvent x Solvent	S-601	70.12	12/1
201-411	4"	Solvent x Solvent	S-601	118.04	6/1
Two-Piece E-Z Turn Valves					
201-417	2-1/2"	Solvent x Solvent	S-601EZ	79.00	12/1
201-418	3"	Solvent x Solvent	S-601EZ	105.78	8/1
201-419	4"	Solvent x Solvent	S-601EZ	210.02	2/1

THERMOPLASTIC VALVES



PVC BALL VALVES

ABS Compact Ball Valve - Black

ISO 9002, 150 psi @ 73°F



S-608

Part No.	Size	Configuration	Model No.	List Price	Cs/Ct
201-467	1-1/2"	Solvent x Solvent	S-608	20.88	48/1

PVC CHECK VALVE

Grey PVC Ball Check Valve

ISO 9002, 150 psi @ 73°F
Naturally lead free



T-655

201-273	1/2"	FNPT x FNPT	T-655	20.14	150/1
201-274	3/4"	FNPT x FNPT	T-655	23.72	100/1
201-275	1"	FNPT x FNPT	T-655	33.27	50/1
201-277	1-1/2"	FNPT x FNPT	T-655	64.80	24/1
201-278	2"	FNPT x FNPT	T-655	82.40	12/1
201-283	1/2"	Solvent x Solvent	S-655	20.14	150/1
201-284	3/4"	Solvent x Solvent	S-655	23.72	100/1
201-285	1"	Solvent x Solvent	S-655	33.27	50/1
201-287	1-1/2"	Solvent x Solvent	S-655	64.80	24/1
201-288	2"	Solvent x Solvent	S-655	82.40	12/1

Grey PVC Foot Valve Screen

Naturally lead free



Screen

201-293	Fits 1/2" T/S-655 only	Foot Valve Screen	11.98	- / -
201-294	Fits 3/4" T/S-655 only	Foot Valve Screen	14.42	- / -
201-295	Fits 1" T/S-655 only	Foot Valve Screen	18.00	- / -
201-297	Fits 1-1/2" T/S-655 only	Foot Valve Screen	34.15	- / -
201-298	Fits 2" T/S-655 only	Foot Valve Screen	43.00	- / -

Changes T/S-655 ball check into foot valve

PVC In-Line Check Valve

ISO 9002, 150 psi @ 73°F
1/2 lb. 304 stainless steel spring
Naturally lead free



T-611

203-103	1/2"	FNPT x FNPT	T-611	6.38	120/1
203-104	3/4"	FNPT x FNPT	T-611	7.35	120/1
203-105	1"	FNPT x FNPT	T-611	10.46	80/1
203-106	1-1/4"	FNPT x FNPT	T-611	13.99	60/1
203-107	1-1/2"	FNPT x FNPT	T-611	14.97	60/1
203-108	2"	FNPT x FNPT	T-611	17.80	40/1
203-203	1/2"	Solvent x Solvent	S-611	6.38	120/1
203-204	3/4"	Solvent x Solvent	S-611	7.35	120/1
203-205	1"	Solvent x Solvent	S-611	10.46	80/1
203-206	1-1/4"	Solvent x Solvent	S-611	13.99	60/1
203-207	1-1/2"	Solvent x Solvent	S-611	14.97	60/1
203-208	2"	Solvent x Solvent	S-611	17.80	40/1

BACKWATER VALVES

Backwater Valve	Part No.	Size	Configuration	Model No.	List Price	Cs/Ct
<p>ISO 9002</p>   	PVC Backwater Valve					
	202-251	1-1/2"	Solvent	S-640	36.18	48/1
	202-252	2"	Solvent	S-640	33.57	48/1
	202-253	3"	Solvent	S-640	35.33	18/1
	202-254	4"	Solvent	S-640	46.78	12/1
	202-255	6"	Solvent	S-640	226.30	- / -
	With 16" Access Sleeve					
	202-262	2"	Solvent	S-641	36.81	4/1
	202-263	3"	Solvent	S-641	44.97	- / -
	202-264	4"	Solvent	S-641	58.45	- / -
	ABS Backwater Valve					
	202-273	3"	Solvent	S-660	35.33	18/1
	202-274	4"	Solvent	S-660	52.62	12/1
	With 16" Access Sleeve					
	202-283	3"	Solvent	S-661	44.97	- / -
202-284	4"	Solvent	S-661	69.31	- / -	

PVC CHECK VALVES

Sump Pump Swing Check Valve	Part No.	Size	Configuration	Model No.	List Price	Cs/Ct
<p>S-613: 25 psi @ 130°F All other models: 150 psi @ 73°F</p>     	Full Flow - Stainless Steel Clamps					
	203-227	1-1/4" - 1-1/2"		S-613	16.22	60/10
	203-228	2"		S-613	32.89	48/6
	Body Only					
	203-230	1-1/4" - 1-1/2"			7.89	- / -
	PVC Compression Swing Check Valves - ISO 9002					
	203-237	1-1/4" - 1-1/2"	Comp	S-614	14.21	64/8
	203-238	2"	Comp	S-614	36.38	16/4
	PVC Check / Ball Combination Valves - ISO 9002					
	203-257	1-1/2"	Solvent x Comp	S-670	38.71	24/4
	203-258	2"	Solvent x Comp	S-670	56.84	12/1
	PVC True Union Swing Check Valve - ISO 9002					
	203-247	1-1/2"	Solvent	S-672	18.29	32/4
	203-248	2"	Solvent	S-672	33.76	16/4

THERMOPLASTIC VALVES



CPVC BALL VALVES

CPVC Compact Ball Valve

ISO 9002, 150 psi @ 73°F
NSF listed
Naturally lead free



Part No.	Size	Configuration	Model No.	List Price	Cs/Ct
Copper Tube Size - Bone color					
202-403*	1/2"	Solvent x Solvent	S-605	6.38	100/1
202-404*	3/4"	Solvent x Solvent	S-605	8.12	100/5
202-405*	1"	Solvent x Solvent	S-605	12.39	100/1
202-406	1-1/4"	Solvent x Solvent	S-605	17.44	100/1
202-407	1-1/2"	Solvent x Solvent	S-605	21.67	48/1
202-408	2"	Solvent x Solvent	S-605	35.92	24/1
<i>*Full Port Design</i>					
With Drain					
202-423	1/2"	Solvent x Solvent	S-606	7.33	100/10
202-424	3/4"	Solvent x Solvent	S-606	9.56	100/5
202-425	1"	Solvent x Solvent	S-606	14.18	100/1
For Schedule 80 Pipe - Grey color					
202-413	1/2"	Solvent x Solvent	S-607	9.99	100/1
202-414	3/4"	Solvent x Solvent	S-607	12.35	100/1
202-415	1"	Solvent x Solvent	S-607	15.09	100/1
202-416	1-1/4"	Solvent x Solvent	S-607	24.73	100/1
202-417	1-1/2"	Solvent x Solvent	S-607	41.24	48/1
202-418	2"	Solvent x Solvent	S-607	53.14	24/1

PLASTIC LOW PRESSURE VALVES

Plastic Low Pressure Valve

125 CWP
Naturally lead free



CPVC Stop Valves

202-503	1/2"	Solvent x Solvent	S-615	4.13	108/12
202-504	3/4"	Solvent x Solvent	S-615	4.38	108/12

CPVC Stop & Waste Valves

202-513	1/2"	Solvent x Solvent	S-617	4.40	108/12
202-514	3/4"	Solvent x Solvent	S-617	4.67	108/12

CPVC Boiler Drains

202-523	1/2"	Solvent x Solvent	S-619	3.96	108/12
202-524	3/4"	Solvent x Solvent	S-619	4.25	108/12

PVC Stop Valves

202-533	1/2"	Solvent x Solvent	S-621	3.65	108/12
202-534	3/4"	Solvent x Solvent	S-621	3.96	108/12

PVC Stop & Waste Valves

202-535	1/2"	Solvent x Solvent	S-622	3.79	108/12
202-536	3/4"	Solvent x Solvent	S-622	4.06	108/12

Celcon® Stop Valves

202-543	1/2"	FNPT x FNPT	T-623	3.89	108/12
202-544	3/4"	FNPT x FNPT	T-623	4.04	108/12

PLASTIC LOW PRESSURE VALVES

Plastic Low Pressure Valve (cont.)

125 CWP
Naturally lead free



Celcon® Stop & Waste Valves

Part No.	Size	Configuration	Model No.	List Price	Cs/Ct
202-545	1/2"	FNPT x FNPT	T-624	3.99	108/12
202-546	3/4"	FNPT x FNPT	T-624	4.14	108/12

Celcon® Boiler Drain Valves

202-553	1/2"	MNPT	T-625	3.92	108/12
202-554	3/4"	MNPT	T-625	4.04	108/12

Celcon® Boiler Drain Valves

202-555	1/2"	FNPT	T-626	3.99	108/12
202-556	3/4"	FNPT	T-626	4.07	108/12

Celcon® Hose Bibbs

202-563	1/2"	MNPT	T-627	4.25	108/12
202-564	3/4"	MNPT	T-627	4.45	108/12

Celcon® Sillcocks

202-573	1/2"	FNPT	T-628	4.58	108/12
202-574	3/4"	FNPT	T-628	4.88	108/12

Celcon® is a registered trademark of the Celanese Corp.

PVC & CPVC UNIONS

Thermoplastic Union

ISO 9002, 150 psi @ 73°F
NSF Listed
Naturally lead free



PVC Schedule 80 Union

PVC Schedule 80 Unions

204-173	1/2"	Solvent x Solvent	2.42	288/36
204-174	3/4"	Solvent x Solvent	3.03	144/24
204-175	1"	Solvent x Solvent	3.95	96/12
204-176	1-1/4"	Solvent x Solvent	6.49	96/12
204-177	1-1/2"	Solvent x Solvent	8.61	64/8
204-178	2"	Solvent x Solvent	13.75	48/4
204-180	3"	Solvent x Solvent	33.04	12/1

ISO 9002, 150 psi @ 73°F
Naturally lead free



PVC Schedule 40 Union

PVC Schedule 40 Unions

204-193	1/2"	Solvent x Solvent	2.26	288/36
204-194	3/4"	Solvent x Solvent	2.96	144/24
204-195	1"	Solvent x Solvent	3.99	96/12
204-196	1-1/4"	Solvent x Solvent	6.29	96/12
204-197	1-1/2"	Solvent x Solvent	7.99	64/8
204-198	2"	Solvent x Solvent	12.99	48/4

ISO 9002, 150 psi @ 73°F
NSF Listed



CPVC Union



CPVC Union

204-133	1/2"	Solvent x Solvent	4.56	288/36
204-134	3/4"	Solvent x Solvent	6.04	288/36

THERMOPLASTIC VALVES





PVC & CPVC UNIONS

Thermoplastic Adapter		Part No.	Size	Configuration	Model No.	List Price	Cs/Ct
150 psi @ 73°F Naturally lead free		PVC Male Adapters					
		204-214	3/4"	MNPT		5.82	18/1
		204-216	1"	MNPT		7.33	25/1
150 psi @ 73°F		PVC Spigot Adapters					
		204-234	3/4"	Spigot		5.82	18/1
		204-235	1"	Spigot		7.33	18/1

CAST IRON VALVES

OS & Y Gate Valve		Part No.	Size	Configuration	Model No.	List Price	Cs/Ct
200 CWP, 125 WSP, Class 125 IBBM design Meets MSS SP-70		OS & Y Gate Valve					
		116-121	2"	Flanged	T-303	335.42	-/-
		116-122	2-1/2"	Flanged	T-303	390.71	-/-
		116-123	3"	Flanged	T-303	496.37	-/-
		116-124	4"	Flanged	T-303	720.49	-/-
		116-125	5"	Flanged	T-303	947.89	-/-
		116-126	6"	Flanged	T-303	1136.49	-/-
		116-127	8"	Flanged	T-303	2131.68	-/-
		116-128	10"	Flanged	T-303	3501.60	-/-
		116-129	12"	Flanged	T-303	4853.09	-/-

Non-Rising Stem Gate Valve		Part No.	Size	Configuration	Model No.	List Price	Cs/Ct
200 CWP, 125 WSP, Class 125 IBBM design Meets MSS SP-70		Non-Rising Stem Gate Valve					
		116-101	2"	Flanged	T-301	304.70	-/-
		116-102	2-1/2"	Flanged	T-301	355.08	-/-
		116-103	3"	Flanged	T-301	425.72	-/-
		116-104	4"	Flanged	T-301	641.96	-/-
		116-105	5"	Flanged	T-301	893.22	-/-
		116-106	6"	Flanged	T-301	1085.50	-/-
		116-107	8"	Flanged	T-301	1809.16	-/-
		116-108	10"	Flanged	T-301	2894.66	-/-
		116-109	12"	Flanged	T-301	4091.35	-/-

Swing Check Valve		304 Stainless Steel 1/16" Perforated Strainer					
Part No.	Size	Configuration	Model No.	List Price	Cs/Ct		
200 CWP, 125 WSP, Class 125 IBBM design Meets MSS SP-71		Swing Check Valve					
		116-201	2"	Flanged	T-311	191.67	-/-
		116-202	2-1/2"	Flanged	T-311	219.31	-/-
		116-203	3"	Flanged	T-311	262.31	-/-
		116-204	4"	Flanged	T-311	368.59	-/-
		116-205	5"	Flanged	T-311	525.13	-/-
		116-206	6"	Flanged	T-311	630.29	-/-
		116-207	8"	Flanged	T-311	1090.41	-/-

Cast & ductile iron valves full freight allowance is \$2500 net

CAST IRON VALVES

Flanged Cast Iron Y- Strainer

200 CWP, 125 WSP, Class 125
Closure plug included



T-19

Part No.	Size	Configuration	Model No.	List Price	Cs/Ct
304 Stainless Steel 1/16" Perforated Strainer					
105-611	2"	Flanged	T-19	169.54	- / -
105-612	2-1/2"	Flanged	T-19	209.30	- / -
105-613	3"	Flanged	T-19	259.31	- / -
105-614	4"	Flanged	T-19	389.79	- / -
304 Stainless Steel 1/8" Perforated Strainer					
105-615	5"	Flanged	T-19	589.99	- / -
105-616	6"	Flanged	T-19	859.00	- / -
105-617	8"	Flanged	T-19	1175.00	- / -

DUCTILE IRON WAFER CHECK VALVES

Wafer Check Valve Bronze Disc

200 CWP, 200°F max temp
Ductile iron body
Twin disc silent check valve
Aluminum bronze disc, EPDM seat,
Spring actuated
ANSI B16.1, API 594



T-312

116-221	2"	Wafer	T-312	90.92	- / -
116-222	2-1/2"	Wafer	T-312	106.89	- / -
116-223	3"	Wafer	T-312	135.46	- / -
116-224	4"	Wafer	T-312	198.38	- / -
116-225	5"	Wafer	T-312	260.10	- / -
116-226	6"	Wafer	T-312	348.19	- / -
116-227	8"	Wafer	T-312	612.91	- / -
116-228	10"	Wafer	T-312	1008.71	- / -
116-229	12"	Wafer	T-312	1468.58	- / -

Wafer Check Valve, Stainless Steel Disc

200 CWP, 200°F max temp
Ductile iron body
Twin disc silent check valve
Stainless steel bronze disc, EPDM seat,
Spring actuated
ANSI B16.1, API 594



T-312 Stainless Steel Disc

NEW 116-231	2"	Wafer	T-312 SS Disc	62.50	18
NEW 116-232	2-1/2"	Wafer	T-312 SS Disc	72.92	12
NEW 116-233	3"	Wafer	T-312 SS Disc	97.23	6
NEW 116-234	4"	Wafer	T-312 SS Disc	130.67	4
NEW 116-235	5"	Wafer	T-312 SS Disc	180.56	1
NEW 116-236	6"	Wafer	T-312 SS Disc	255.83	1
NEW 116-237	8"	Wafer	T-312 SS Disc	425.18	1
NEW 116-238	10"	Wafer	T-312 SS Disc	717.05	1
NEW 116-239	12"	Wafer	T-312 SS Disc	1005.31	1

Wafer Check Valve, Ductile Iron Disc

200 CWP, 200°F max temp
Ductile iron body
Twin disc silent check valve
Ductile iron bronze disc, EPDM seat,
Spring actuated
ANSI B16.1, API 594







T-312 Ductile Iron Disc

NEW 116-241	2"	Wafer	T-312 Ductile Iron	48.61	18
NEW 116-242	2-1/2"	Wafer	T-312 Ductile Iron	59.03	12
NEW 116-243	3"	Wafer	T-312 Ductile Iron	72.92	6
NEW 116-244	4"	Wafer	T-312 Ductile Iron	93.89	4
NEW 116-245	5"	Wafer	T-312 Ductile Iron	131.95	1
NEW 116-246	6"	Wafer	T-312 Ductile Iron	172.96	1
NEW 116-247	8"	Wafer	T-312 Ductile Iron	281.05	1
NEW 116-248	10"	Wafer	T-312 Ductile Iron	443.20	1
NEW 116-249	12"	Wafer	T-312 Ductile Iron	626.97	1

Cast & ductile iron valves full freight allowance is \$2500 net



DUCTILE IRON BUTTERFLY VALVES

Wafer Type Aluminum Bronze Disc	Part No.	Size	Configuration	Model No.	List Price	Cs/Ct	
EPDM Seat ISO 9002, 200 CWP, 125 WSP Meets API 609, EN 593, MSS SP-67, & AWWA C504 Ductile iron body & aluminum bronze disc 416 SS Stem	Lever Handle - 10 Position						
		116-401	2"	Wafer	T-335AB	107.44	- / -
		116-402	2-1/2"	Wafer	T-335AB	123.44	- / -
		116-403	3"	Wafer	T-335AB	147.81	- / -
		116-404	4"	Wafer	T-335AB	224.09	- / -
		116-405	5"	Wafer	T-335AB	270.24	- / -
		116-406	6"	Wafer	T-335AB	364.53	- / -
		116-407	8"	Wafer	T-335AB	603.74	- / -
		116-408	10"	Wafer	T-335AB	963.16	- / -
		116-409	12"	Wafer	T-335AB	1423.56	- / -
	T-335AB						
EPDM Seat ISO 9002, 200 CWP, 125 WSP Meets API 609, EN 593, MSS SP-67, & AWWA C504 Ductile iron body & aluminum bronze disc 416 SS Stem	Gear Operator						
		116-441	2"	Wafer	T-335AB-G	197.61	- / -
		116-442	2-1/2"	Wafer	T-335AB-G	213.75	- / -
		116-443	3"	Wafer	T-335AB-G	237.07	- / -
		116-444	4"	Wafer	T-335AB-G	306.91	- / -
		116-445	5"	Wafer	T-335AB-G	360.18	- / -
		116-446	6"	Wafer	T-335AB-G	447.36	- / -
		116-447	8"	Wafer	T-335AB-G	756.79	- / -
		116-448	10"	Wafer	T-335AB-G	1114.95	- / -
		116-449	12"	Wafer	T-335AB-G	1575.29	- / -
	T-335AB-G						
Buna-N Seat ISO 9002, 200 CWP, 125 WSP Meets API 609, EN 593, MSS SP-67, & AWWA C504 Ductile iron body & aluminum bronze disc 416 SS Stem	Lever Handle - 10 Position						
		116-421	2"	Wafer	T-337AB	107.44	- / -
		116-422	2-1/2"	Wafer	T-337AB	123.44	- / -
		116-423	3"	Wafer	T-337AB	147.81	- / -
		116-424	4"	Wafer	T-337AB	224.09	- / -
		116-425	5"	Wafer	T-337AB	270.24	- / -
		116-426	6"	Wafer	T-337AB	364.53	- / -
		116-427	8"	Wafer	T-337AB	603.74	- / -
		116-428	10"	Wafer	T-337AB	963.16	- / -
		116-429	12"	Wafer	T-337AB	1423.56	- / -
	T-337AB						
Buna-N Seat ISO 9002, 200 CWP, 125 WSP Meets API 609, EN 593, MSS SP-67, & AWWA C504 Ductile iron body & aluminum bronze disc 416 SS Stem	Gear Operator						
		116-461	2"	Wafer	T-337AB-G	211.48	- / -
		116-462	2-1/2"	Wafer	T-337AB-G	228.75	- / -
		116-463	3"	Wafer	T-337AB-G	253.65	- / -
		116-464	4"	Wafer	T-337AB-G	328.41	- / -
		116-465	5"	Wafer	T-337AB-G	385.39	- / -
		116-466	6"	Wafer	T-337AB-G	478.68	- / -
		116-467	8"	Wafer	T-337AB-G	809.74	- / -
		116-468	10"	Wafer	T-337AB-G	1192.99	- / -
		116-469	12"	Wafer	T-337AB-G	1685.60	- / -
	T-337AB-G						

Cast & ductile iron valves full freight allowance is \$2500 net

DUCTILE IRON BUTTERFLY VALVES

Wafer Type Stainless Steel Disc

EPDM Seat

ISO 9002, 200 CWP, 125 WSP
Meets API 609, EN 593,
MSS SP-67, & AWWA C504
Ductile iron body &
316 stainless steel disc
416 SS Stem



T-335SS

Lever Handle - 10 Position

Part No.	Size	Configuration	Model No.	List Price	Cs/Ct
NEW 116-411	2"	Wafer	T-335SS	107.44	-/-
NEW 116-412	2-1/2"	Wafer	T-335SS	123.44	-/-
NEW 116-413	3"	Wafer	T-335SS	147.81	-/-
NEW 116-414	4"	Wafer	T-335SS	224.09	-/-
NEW 116-415	5"	Wafer	T-335SS	275.24	-/-
NEW 116-416	6"	Wafer	T-335SS	370.53	-/-
NEW 116-417	8"	Wafer	T-335SS	610.54	-/-
NEW 116-418	10"	Wafer	T-335SS	973.16	-/-
NEW 116-419	12"	Wafer	T-335SS	1459.73	-/-

Buna-N Seat

ISO 9002, 200 CWP, 125 WSP
Meets API 609, EN 593,
MSS SP-67, & AWWA C504
Ductile iron body &
316 stainless steel disc
416 SS Stem



T-337SS

Lever Handle - 10 Position

NEW 116-431	2"	Wafer	T-337SS	107.44	-/-
NEW 116-432	2-1/2"	Wafer	T-337SS	123.44	-/-
NEW 116-433	3"	Wafer	T-337SS	147.81	-/-
NEW 116-434	4"	Wafer	T-337SS	224.09	-/-
NEW 116-435	5"	Wafer	T-337SS	275.24	-/-
NEW 116-436	6"	Wafer	T-337SS	370.53	-/-
NEW 116-437	8"	Wafer	T-337SS	610.54	-/-
NEW 116-438	10"	Wafer	T-337SS	973.16	-/-
NEW 116-439	12"	Wafer	T-337SS	1459.73	-/-

Lug Type Aluminum Bronze Disc

EPDM Seat

ISO 9002, 200 CWP, 125 WSP
Meets API 609, EN 593,
MSS SP-67, & AWWA C504
Ductile iron body &
aluminum bronze disc
416 SS Stem



T-365AB

Lever Handle - 10 Position

116-601	2"	Lug	T-365AB	118.32	-/-
116-602	2-1/2"	Lug	T-365AB	138.42	-/-
116-603	3"	Lug	T-365AB	174.42	-/-
116-604	4"	Lug	T-365AB	257.56	-/-
116-605	5"	Lug	T-365AB	319.14	-/-
116-606	6"	Lug	T-365AB	409.41	-/-
116-607	8"	Lug	T-365AB	708.69	-/-
116-608	10"	Lug	T-365AB	1063.83	-/-
116-609	12"	Lug	T-365AB	1534.76	-/-

EPDM Seat

ISO 9002, 200 CWP, 125 WSP
Meets API 609, EN 593,
MSS SP-67, & AWWA C504
Ductile iron body &
aluminum bronze disc
416 SS Stem



T-365AB-G

Gear Operator

116-641	2"	Lug	T-365AB-G	207.57	-/-
116-642	2-1/2"	Lug	T-365AB-G	227.74	-/-
116-643	3"	Lug	T-365AB-G	263.67	-/-
116-644	4"	Lug	T-365AB-G	340.38	-/-
116-645	5"	Lug	T-365AB-G	402.03	-/-
116-646	6"	Lug	T-365AB-G	492.30	-/-
116-647	8"	Lug	T-365AB-G	861.68	-/-
116-648	10"	Lug	T-365AB-G	1215.61	-/-
116-649	12"	Lug	T-365AB-G	1686.54	-/-

Cast & ductile iron valves full freight allowance is \$2500 net

CAST IRON VALVES



DUCTILE IRON BUTTERFLY VALVES

Lug Type Aluminum Bronze Disc		Part No.	Size	Configuration	Model No.	List Price	Cs/Ct
Buna N Seat		Lever Handle - 10 Position					
ISO 9002, 200 CWP, 125 WSP Meets API 609, EN 593, MSS SP-67, & AWWA C504 Ductile iron body & aluminum bronze disc 416 SS Stem		116-621	2"	Lug	T-367AB	118.32	- / -
		116-622	2-1/2"	Lug	T-367AB	138.42	- / -
		116-623	3"	Lug	T-367AB	174.42	- / -
		116-624	4"	Lug	T-367AB	257.56	- / -
		116-625	5"	Lug	T-367AB	319.14	- / -
		116-626	6"	Lug	T-367AB	409.41	- / -
		116-627	8"	Lug	T-367AB	708.69	- / -
		116-628	10"	Lug	T-367AB	1063.83	- / -
		116-629	12"	Lug	T-367AB	1534.76	- / -
		Buna N Seat		Gear Operator			
ISO 9002, 200 CWP, 125 WSP Meets API 609, EN 593, MSS SP-67, & AWWA C504 Ductile iron body & aluminum bronze disc 416 SS Stem		116-661	2"	Lug	T-367AB-G	207.57	- / -
		116-662	2-1/2"	Lug	T-367AB-G	227.74	- / -
		116-663	3"	Lug	T-367AB-G	263.67	- / -
		116-664	4"	Lug	T-367AB-G	340.38	- / -
		116-665	5"	Lug	T-367AB-G	402.03	- / -
		116-666	6"	Lug	T-367AB-G	492.30	- / -
		116-667	8"	Lug	T-367AB-G	861.68	- / -
		116-668	10"	Lug	T-367AB-G	1215.61	- / -
		116-669	12"	Lug	T-367AB-G	1686.54	- / -

Lug Type Stainless Steel Disc

EPDM Seat		Lever Handle - 10 Position						
ISO 9002, 200 CWP, 125 WSP Meets API 609, EN 593, MSS SP-67, & AWWA C504 Ductile iron body & 316 stainless steel disc 416 SS Stem		NEW	116-611	2"	Lug	T-365SS	118.32	- / -
		NEW	116-612	2-1/2"	Lug	T-365SS	138.42	- / -
		NEW	116-613	3"	Lug	T-365SS	174.42	- / -
		NEW	116-614	4"	Lug	T-365SS	257.56	- / -
		NEW	116-615	5"	Lug	T-365SS	325.00	- / -
		NEW	116-616	6"	Lug	T-365SS	415.41	- / -
		NEW	116-617	8"	Lug	T-365SS	712.69	- / -
		NEW	116-618	10"	Lug	T-365SS	1083.83	- / -
		NEW	116-619	12"	Lug	T-365SS	1565.76	- / -
		Buna N Seat		Lever Handle - 10 Position				
ISO 9002, 200 CWP, 125 WSP Meets API 609, EN 593, MSS SP-67, & AWWA C504 Ductile iron body & 316 stainless steel disc 416 SS Stem		NEW	116-631	2"	Lug	T-367SS	118.32	- / -
		NEW	116-632	2-1/2"	Lug	T-367SS	138.42	- / -
		NEW	116-633	3"	Lug	T-367SS	174.42	- / -
		NEW	116-634	4"	Lug	T-367SS	257.56	- / -
		NEW	116-635	5"	Lug	T-367SS	325.00	- / -
		NEW	116-636	6"	Lug	T-367SS	415.41	- / -
		NEW	116-637	8"	Lug	T-367SS	712.69	- / -
		NEW	116-638	10"	Lug	T-367SS	1083.83	- / -
		NEW	116-639	12"	Lug	T-367SS	1565.76	- / -

Cast & ductile iron valves full freight allowance is \$2500 net

DUCTILE IRON BUTTERFLY VALVES

Gear Operator with Handle

Gear operator only



Gear operator with handwheel

Part No.	Size	Configuration	Model No.	List Price	Cs/Ct
Includes Handwheel					
116-381	Fits 2" - 3"		Gear	91.61	- / -
116-382	Fits 4"		Gear	91.61	- / -
116-383	Fits 5" - 6"		Gear	91.61	- / -
116-384	Fits 8"		Gear	156.02	- / -
116-385	Fits 10"-12"		Gear	199.70	- / -

Cast & ductile iron valves full freight allowance is \$2500 net

Did you know? Legend allows you to return non-obsolete materials without a restocking charge.



We've got your back. Traci, Melissa, Alyssa, Maggie, Jason, Larry



Here to assist you, we are one call away.

BACKFLOW VALVES

Backflow Preventer

Backflow preventers, atmospheric vent
ISO 9002, 175 psi @ 210°F
ASSE 1012, CSA B64.3



T-459

Part No.	Size	Configuration	Model No.	List Price	Cs/Ct
115-113	1/2"	FNPT x FNPT	T-459	65.55	25/1
115-114	3/4"	FNPT x FNPT	T-459	65.55	25/1
115-117	1/2"	Sweat x Sweat	S-459	65.55	25/1
115-118	3/4"	Sweat x Sweat	S-459	65.55	25/1

Dual Check Backflow Preventer

ISO 9002, 150 psi @ 180°F
ASSE 1024, CSA B64.6
ANSI/NSF 61-G (T-457NL)
Min operating pressure 10 psi



T-457

115-103	1/2"	FNPT x FNPT	T-457	50.03	25/1
115-103NL	1/2"	FNPT x FNPT	T-457NL	59.04	25/1
115-104	3/4"	FNPT x FNPT	T-457	50.03	25/1
115-104NL	3/4"	FNPT x FNPT	T-457NL	59.04	25/1
115-105	1"	FNPT x FNPT	T-457	60.80	25/1
115-105NL	1"	FNPT x FNPT	T-457NL	75.36	25/1

Vacuum Breaker

ISO 9002, 125 CWP
Max temp 180°F
ASSE 1011, CSA B64.2
ANSI/NSF 372 (NL Only)



T-553



T-554

107-194	3/4"	FGHT x MGHT	T-553	4.99	200/20
107-194NL	3/4"	FGHT x MGHT	T-553NL	6.99	200/20
107-195	3/4"	FGHT x MGHT	T-553C	5.67	200/20
107-195NL	3/4"	FGHT x MGHT	T-553CNL	7.75	200/20
Manual Drain					
107-196	3/4"	FGHT x MGHT	T-554	14.89	200/20

Dual Check Vacuum Breaker

ISO 9002, 125 CWP
Max temp 180°F
ASSE 1052, CSA B64.2
ANSI B1.20.7



T-556

107-198	3/4"	FGHT x MGHT	T-556	16.63	200/10
---------	------	-------------	-------	-------	--------

Self Draining Vacuum Breaker

ISO 9002, 125 CWP
Max temp 180°F
ASSE 1011, CSA B64.2.2
ANSI B1.20.7



T-557











T-557C

107-193	3/4"	FGHT x MGHT	T-557	7.56	144/12
107-199	3/4"	FGHT x MGHT	T-557C	9.37	200/10

SPECIALTY PRODUCTS

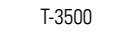

LOG LIGHTER VALVES

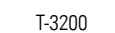
Log Lighter Valve	Part No.	Size	Configuration	Model No.	List Price	Cs/Ct
Forged brass ISO 9002, CSA Certified ANSI Z21.15 (1/2 lb. system) Chrome-plated brass escutcheon *PB indicates polished brass escutcheon	Straight Pattern, 1/4 Turn Ball-Type					
	102-863	1/2"	FNPT x FNPT	T-3500	43.39	25/1
	102-864	1/2"	FNPT x FNPT	T-3500PB*	43.39	25/1
	Angle Pattern, 1/4 Turn Ball-Type					
	102-873	1/2"	FNPT x FNPT	T-3501	43.39	25/1
	102-874	1/2"	FNPT x FNPT	T-3501PB*	43.39	25/1
	Straight Pattern, Multi-Turn Globe-Type (100 psi max air pressure, non-shock)					
	102-803	1/2"	FNPT x FNPT	T-3200	33.61	25/1
	102-804	1/2"	FNPT x FNPT	T-3200PB*	38.69	25/1
	Angle Pattern, Multi-Turn Globe-Type (100 psi max air pressure, non-shock)					
	102-813	1/2"	FNPT x FNPT	T-3201	33.19	25/1
	102-814	1/2"	FNPT x FNPT	T-3201PB*	37.16	25/1

Accessories



102-820	Chrome Escutcheon	18.28	- / -
102-821	Polished Brass Escutcheon	20.22	- / -
102-840	1/4 Turn Chrome Escutcheon	16.90	- / -
102-841	1/4 Turn Polished Brass Escutcheon	16.90	- / -
102-850	Chrome Key	3.84	400/50
102-851	Polished Brass Key	4.07	50/-
102-823	5/16" - 8" Chrome Key	6.25	- / -
102-824	8" Chrome Key	7.97	- / -
102-825	8" Polished Brass Key	8.39	- / -
102-827	10" Polished Brass key	13.33	- / -
102-852	12" Chrome Key	9.87	60/-
102-853	12" Polished Brass Key	10.52	120/60

Natural Gas Burner Bar

Not for use with LP gas



T-Style with Ash Protector Ledge						
102-830	1/2"	FNPT	T-3205	15.83	20/1	

Log Lighter Kit

CSA Certified
ANSI Z21.15 (1/2 lb. system)
Not for use with LP gas



With Chrome Straight Pattern Globe Valve						
102-833	1/2"	FNPT x FNPT	T-3200	60.67	- / -	
With Polished Brass Straight Pattern Globe Valve						
102-834	1/2"	FNPT x FNPT	T-3200PB	60.67	- / -	
With Chrome Angle Pattern Globe Valve						
102-843	1/2"	FNPT x FNPT	T-3201	67.43	- / -	
With Polished Brass Angle Pattern Globe Valve						
102-844	1/2"	FNPT x FNPT	T-3201PB	67.43	- / -	
With Chrome Straight Pattern Ball Valve						
102-883	1/2"	FNPT x FNPT	T-3500	74.15	- / -	

LOG LIGHTER VALVES

Log Lighter Kit (cont.)	Part No.	Size	Configuration	Model No.	List Price	Cs/Ct
 T-3200	With Polished Brass Straight Pattern Ball Valve					
	102-884	1/2"	FNPT x FNPT	T-3500PB	74.15	- / -
	With Chrome Angle Pattern Ball Valve					
	102-893	1/2"	FNPT x FNPT	T-3501	74.15	- / -
	With Polished Brass Angle Pattern Ball Valve					
	102-894	1/2"	FNPT x FNPT	T-3501PB	74.15	- / -

PRESSURE REDUCING VALVES

Water Pressure Reducing Valve

No lead brass
ISO 9002, 300 CWVP
ANSI/NSF 61-G, ASSE 1003, CSA B 356
Range 25 to 75 psi
Max temp 180°F
Factory preset at 50 psi
Third party certified Truesdail



T-6800NL

111-323NL	1/2"	FNPT x FNPT	T-6800NL	114.65	16/1
111-324NL	3/4"	FNPT x FNPT	T-6800NL	121.97	16/1
111-325NL	1"	FNPT x FNPT	T-6800NL	179.03	16/1
111-333NL	1/2"	FNPT x FNPT	T-6801NL	65.00	24/1
111-334NL	3/4"	FNPT x FNPT	T-6801NL	69.00	24/1
111-335NL	1"	FNPT x FNPT	T-6801NL	89.00	16/1



T-6801NL



T-6803NL Plastic

Polycarbonate Resin, Reinforced Glass

NEW	111-033NL	1/2"	FNPT x FNPT	T-6803NL Plastic	58.12	24/1
NEW	111-034NL	3/4"	FNPT x FNPT	T-6803NL Plastic	61.17	24/1
NEW	111-035NL	1"	FNPT x FNPT	T-6803NL Plastic	75.43	16/1

Brass Bonnet

NEW	112-033NL	1/2"	FNPT x FNPT	T-6803NL Brass	70.67	24/1
NEW	112-034NL	3/4"	FNPT x FNPT	T-6803NL Brass	74.39	24/1
NEW	112-035NL	1"	FNPT x FNPT	T-6803NL Brass	94.74	16/1



T-6803NL Brass

Did you know? Legend guarantees our products for 5 years or you will receive \$25.00 back.



MIXING VALVES

Mixing Valve

ISO 9002, 230 psi, temp range
100-140°F
Max temp 185°F
ASSE 1017



T-41

Part No.	Size	Configuration	Model No.	List Price	Cs/Ct
Mixing Valve for Radiant Heating					
115-153	1/2"	FNPT x FNPT	T-41	196.98	25/1
115-154	3/4"	FNPT x FNPT	T-41	196.98	25/1
115-155	1"	FNPT x FNPT	T-41	196.98	25/1

METER VALVES

Bronze Angle Meter Valve

ISO 9002, 125 CWP
ANSI/NSF 61-G



T-442NL



T-441NL

111-103NL	3/4" x 1/2"	Flare x FNPT	T-441NL	50.08	60/6
111-104NL	3/4" x 3/4"	Flare x FNPT	T-441NL	50.08	60/6
111-105NL	1" x 3/4"	Flare x FNPT	T-441NL	60.64	60/6
111-106NL	1" x 1"	Flare x FNPT	T-441NL	83.29	40/5

With Waste

111-113NL	3/4" x 1/2"	Flare x FNPT	T-442NL	51.14	60/6
111-114NL	3/4" x 3/4"	Flare x FNPT	T-442NL	51.14	60/6
111-115NL	1" x 3/4"	Flare x FNPT	T-442NL	61.91	60/6
111-116NL	1" x 1"	Flare x FNPT	T-442NL	85.03	40/5

1/4 Turn Meter Angle Ball Valve

ISO 9002, 400 CWP
ANSI B1.20.1, NSF 61-G
AWWA 800



T-443NL

111-123NL	3/4" x 3/4"	FNPT x Flare	T-443NL	55.37	20/2
111-124NL	3/4" x 1"	FNPT x Flare	T-443NL	66.16	20/2
111-125NL	1" x 1"	FNPT x Flare	T-443NL	84.00	20/2

WASHING MACHINE VALVES

Washing Machine Valve

150 CWP
ANSI/NSF 372 (NL only)
Max temp 180°F



T-11



S-11



T-12

1/2" T-11 has combination 1/2" MNPT and 1/2" Sweat inlet connection					
111-133	1/2"	MNPT / Sweat x MGHT	T-11	40.85	40/1
111-133NL	1/2"	MNPT / Sweat x MGHT	T-11NL	53.69	40/1
111-134	1/2"	Sweat x MGHT	S-11	47.07	40/1
111-134NL	1/2"	Sweat x MGHT	S-11NL	61.88	40/1

111-136	T/S-11 Repair Kit			13.30	- / -
---------	-------------------	--	--	-------	-------

Satin Chrome Plated

111-137	5/8" OD x HOSE	Comp x MGHT	T-12	11.39	144/12
111-137NL	5/8" OD x HOSE	Comp x MGHT	T-12NL	13.52	144/12

DISHWASHER ELBOW

No Lead Dishwasher Elbow

ANSI/NSF 372



Elbow

Part No.	Size	Configuration	Model No.	List Price	Cs/Ct
302-210NL	3/8" x 3/4"	OD x FGHT	Elbow	6.77	100

PRESSURE RELIEF VALVE

Pressure Relief Valve

150 psi
ISO 9002
ANSI/NSF 61



T-50NL

Factory Set @ 75 PSI (Adjustable 75 to 150)

111-302NL	1/2"	MNPT x FNPT	T-50NL PRV	11.79	- / -
111-304NL	3/4"	MNPT x FNPT	T-50NL PRV	12.67	- / -

Factory Set @ 100 PSI (Adjustable 75 to 150)

111-303NL	1/2"	MNPT x FNPT	T-50NL PRV	11.79	- / -
111-305NL	3/4"	MNPT x FNPT	T-50NL PRV	12.67	- / -

FLOAT VALVES

Bronze Float Valve

125 CWP



T-30



T-31



T-32

Main Inlet - Plain Outlet

111-222	3/8" (1/4" - 20)	MNPT	T-30	20.50	72/12
111-223	1/2" (1/4" - 20)	MNPT	T-30	22.92	72/12
111-224	3/4" (1/4" - 20)	MNPT	T-30	30.37	48/12

Female Inlet - Plain Outlet

111-235	1" (5/16" - 18)	FNPT	T-31	51.27	36/6
111-236	1-1/4" (3/8" - 16)	FNPT	T-31	81.83	20/2
111-237	1-1/2" (3/8" - 16)	FNPT	T-31	84.03	16/2
111-238	2" (3/8" - 16)	FNPT	T-31	94.36	16/2

Main Inlet - Male Outlet

111-243	1/2" (1/4" - 20)	MNPT x MNPT	T-32	23.83	72/12
111-244	3/4" (1/4" - 20)	MNPT x MNPT	T-32	32.82	48/12

Brass Float Rod





Float Rod

111-253	1/4"-20 x 10"		Float Rod	5.37	- / -
111-254	1/4"-20 x 12"		Float Rod	5.96	- / -
111-255	5/16"-18 x 12"		Float Rod	7.95	- / -
111-256	3/8"-16 x 12"		Float Rod	11.01	- / -



EVAPORATIVE COOLER VALVES

Float	Part No.	Size	Configuration	Model No.	List Price	Cs/Ct
 Copper Float	Copper - Seamless					
	111-263	1/4"-20 x 5"		Copper- Seamless	77.73	- / -
	111-264	1/4"-20 x 6"		Copper- Seamless	93.61	- / -
	111-265	5/16"-18 x 7"		Copper- Seamless	123.80	- / -
 Plastic Float	Plastic - Polystyrene					
	111-273	1/4"-20 x 5"		Plastic - Polystyrene	40.30	- / -
	111-274	1/4"-20 x 6"		Plastic - Polystyrene	44.27	- / -
	111-275	5/16"-18 x 7"		Plastic - Polystyrene	45.16	- / -
	111-276	3/8"-16 x 8"		Plastic - Polystyrene	48.42	- / -

Evaporative Cooler Valve

125 CWP
ANSI/NSF 61-G (T-542NL only)



107-247	3/4"	FGHT x MGHT	T-542	8.33	144/12
107-247NL	3/4"	FGHT x MGHT	T-542NL	10.76	144/12

Standard Pattern

111-247	1/4"	Compression	T-34	15.99	80/10
---------	------	-------------	------	-------	-------

Compact Pattern

111-248	1/4"	Compression	T-35	10.50	160/10
---------	------	-------------	------	-------	--------

ANTI-SWEAT VALVES

Anti-Sweat Valves for Toilet Tank

180°F max service temp
125 CWP



Factory Set @ 30% Hot / 70% Cold Mix

111-152	1/2"	MNPT / Comp	T-20	23.00	100/1
---------	------	-------------	------	-------	-------

Manually Adjustable from 30% hot to 0% (100% cold)

111-154	1/2"	MNPT / Comp	T-20A	25.30	100/1
---------	------	-------------	-------	-------	-------

Compression Nuts & Ferrules - Set of Three

111-158	1/2"	Compression		7.99	- / -
---------	------	-------------	--	------	-------

Did you know? Legend performance can increase your inventory turns three to four times.

DIELECTRIC FITTINGS

Dielectric Nipple

425 psi @ 225°F max temp
10 WSP
Long pattern
Naturally lead free
ASTM F 1545-2009
ANSI B1.20.1
ISO 9002



T-575

Part No.	Size	Configuration	Model No.	List Price	Cs/Ct
301-502	1/2" x 3"	MNPT x MNPT	T-575	3.25	300/50
301-503	3/4" x 3"	MNPT x MNPT	T-575	3.40	200/50
301-504	1" x 4"	MNPT x MNPT	T-575	7.03	120/20
301-505	1-1/4" x 4"	MNPT x MNPT	T-575	9.98	80/10
301-506	1-1/2" x 4"	MNPT x MNPT	T-575	12.86	60/10
301-507	2" x 4"	MNPT x MNPT	T-575	17.60	40/5

Dielectric Coupling

125 CWVP, 180°F max temp



T-578

301-533	1/2"	FNPT x FNPT	T-578	14.89	144/12
301-534	3/4"	FNPT x FNPT	T-578	16.25	144/12
301-535	1"	FNPT x FNPT	T-578	18.94	144/12
301-536	1-1/4"	FNPT x FNPT	T-578	25.89	48/6
301-537	1-1/2"	FNPT x FNPT	T-578	39.16	48/6
301-538	2"	FNPT x FNPT	T-578	46.03	48/6

Forged Steel Dielectric Union

200 CWVP, 180°F max temp
NSF 372 (T-571NL)
ISO 9002
2-1/2", 3" & 4" are flanged



T-571NL
1/2" - 2"



T-571NL
2 1/2", 3" & 4"



Grommet

301-103NL	1/2"	FNPT x Sweat	T-571NL	6.89	144/12
301-104NL	3/4"	FNPT x Sweat	T-571NL	7.11	144/12
301-123NL	3/4" x 1/2"	FNPT x Sweat	T-571NL	7.01	144/12
301-105NL	1"	FNPT x Sweat	T-571NL	10.40	120/12
301-125NL	1" x 3/4"	FNPT x Sweat	T-571NL	11.97	120/12
301-106NL	1-1/4"	FNPT x Sweat	T-571NL	16.37	48/6
301-107NL	1-1/2"	FNPT x Sweat	T-571NL	26.21	48/6
301-108NL	2"	FNPT x Sweat	T-571NL	36.64	24/6
301-119NL	2-1/2"	FNPT x Sweat	T-571NL	178.27	5/1
301-120NL	3"	FNPT x Sweat	T-571NL	210.11	2/1
301-121NL	4"	FNPT x Sweat	T-571NL	757.48	2/1

301-421 For 4" T-571NL 1.73 - / -

301-203NL	1/2"	MNPT x Sweat	T-571M x SNL	8.54	144/12
301-204NL	3/4"	MNPT x Sweat	T-571M x SNL	8.82	144/12
301-205NL	3/4" x 1/2"	MNPT x Sweat	T-571M x SNL	9.30	144/12

Galvanized x Galvanized Dielectric Union

200 CWVP, 180°F max temp
ISO 9002



T-572
FNPT x FNPT

301-303	1/2"	FNPT x FNPT	T-572	9.24	144/12
301-304	3/4"	FNPT x FNPT	T-572	9.90	120/12
301-305	1"	FNPT x FNPT	T-572	15.29	48/6
301-306	1-1/4"	FNPT x FNPT	T-572	28.92	48/6
301-307	1-1/2"	FNPT x FNPT	T-572	38.06	24/6
301-308	2"	FNPT x FNPT	T-572	44.69	20/6



DIELECTRIC FITTINGS

Galvanized x Brass Dielectric Union

200 CWP, 180°F max temp
NSF 372
ISO 9002



T-573NL
FNPT x FNPT

Part No.	Size	Configuration	Model No.	List Price	Cs/Ct
301-323NL	1/2"	FNPT x FNPT	T-573NL	16.47	144/12
301-324NL	3/4"	FNPT x FNPT	T-573NL	18.90	120/12
301-325NL	1"	FNPT x FNPT	T-573NL	35.00	48/6

Black Gas Service Dielectric Union

200 CWP, 180°F max temp
ISO 9002



T-574
FNPT x FNPT

301-333	1/2"	FNPT x FNPT	T-574	8.26	144/12
301-334	3/4"	FNPT x FNPT	T-574	9.46	120/12
301-335	1"	FNPT x FNPT	T-574	14.77	48/6
301-336	1-1/4"	FNPT x FNPT	T-574	25.90	48/6
301-337	1-1/2"	FNPT x FNPT	T-574	43.26	24/6
301-338	2"	FNPT x FNPT	T-574	51.63	20/2

Rubber Gasket

Max temp 180°F
Fits models T-571, T-572 & T-573



Rubber Gasket

301-403	1/2"	Rubber Gasket	0.41	- / -
301-404	3/4"	Rubber Gasket	0.41	- / -
301-405	1"	Rubber Gasket	0.49	- / -
301-406	1-1/4"	Rubber Gasket	0.49	- / -
301-407	1-1/2"	Rubber Gasket	0.59	- / -
301-408	2"	Rubber Gasket	0.69	- / -
301-409	2-1/2"	Rubber Gasket	2.39	- / -
301-410	3"	Rubber Gasket	2.79	- / -
301-411	4"	Rubber Gasket	7.89	- / -

Gaskets & Inserts For Steam

Max temp 275°F continuous
300°F intermittent
Fits models T-571, T-572 & T-573



Steam Gasket

Steam Gaskets

301-433	1/2"	Steam Gasket	1.65	- / -
301-434	3/4"	Steam Gasket	1.90	- / -
301-435	1"	Steam Gasket	2.39	- / -
301-436	1-1/4"	Steam Gasket	2.88	- / -
301-437	1-1/2"	Steam Gasket	3.49	- / -
301-438	2"	Steam Gasket	3.99	- / -
301-439	2-1/2"	Steam Gasket	21.99	- / -
301-440	3"	Steam Gasket	28.65	- / -
301-441	4"	Steam Gasket	43.45	- / -

Gaskets & Inserts For Steam



Steam ABS Insert

Steam ABS Inserts

301-443	1/2"	Steam ABS Insert	0.54	- / -
301-444	3/4"	Steam ABS Insert	0.69	- / -
301-445	1"	Steam ABS Insert	0.80	- / -
301-446	1-1/4"	Steam ABS Insert	0.85	- / -
301-447	1-1/2"	Steam ABS Insert	0.96	- / -
301-448	2"	Steam ABS Insert	1.03	- / -
301-449	2-1/2"	Steam ABS Insert	5.83	- / -
301-450	3"	Steam ABS Insert	6.38	- / -

COMPRESSION REPAIR FITTINGS

Galvanized Compression Coupling

125 CWP max temp 210°F
Long pattern



Galvanized
Compression Coupling

Part No.	Size	Configuration	Model No.	List Price	Cs/Ct
303-103	1/2"	Comp (IPS) x Comp (IPS)		7.49	48/24
303-104	3/4"	Comp (IPS) x Comp (IPS)		9.39	48/24
303-105	1"	Comp (IPS) x Comp (IPS)		11.90	48/24
303-106	1-1/4"	Comp (IPS) x Comp (IPS)		16.23	24/12
303-107	1-1/2"	Comp (IPS) x Comp (IPS)		18.97	24/12
303-108	2"	Comp (IPS) x Comp (IPS)		23.82	16/8

Brass Compression Coupling

125 CWP max temp 180°F
ANSI/NSF 61-G (NL only)
Long pattern



Brass
Compression Coupling

303-123	3/8" x 1/2"	Comp (IPS) x Comp (CTS)		10.30	144/12
303-123NL	3/8" x 1/2"	Comp (IPS) x Comp (CTS)		13.30	144/12
303-124	1/2" x 3/4"	Comp (IPS) x Comp (CTS)		13.21	108/12
303-124NL	1/2" x 3/4"	Comp (IPS) x Comp (CTS)		18.23	108/12
303-125	3/4" x 1"	Comp (IPS) x Comp (CTS)		19.64	48/12
303-125NL	3/4" x 1"	Comp (IPS) x Comp (CTS)		26.65	48/12
303-126	1" x 1-1/4"	Comp (IPS) x Comp (CTS)		22.96	48/12
303-126NL	1" x 1-1/4"	Comp (IPS) x Comp (CTS)		29.46	48/12
303-127	1-1/4" x 1-1/2"	Comp (IPS) x Comp (CTS)		37.05	48/12
303-127NL	1-1/4" x 1-1/2"	Comp (IPS) x Comp (CTS)		47.50	48/12
303-128	1-1/2"	Comp (IPS) x Comp (IPS)		35.16	36/12
303-128NL	1-1/2"	Comp (IPS) x Comp (IPS)		44.66	36/12
303-129	2"	Comp (CTS) x Comp (CTS)		43.69	36/12
303-129NL	2"	Comp (CTS) x Comp (CTS)		53.48	36/12

PVC Compression Coupling

Naturally lead free
ISO 9002, 150 CWP @ 73°F
Long pattern



PVC
Compression Coupling

204-103	1/2"	Comp (IPS) x Comp (IPS)		1.98	240/20
204-104	3/4"	Comp (IPS) x Comp (IPS)		2.39	120/20
204-105	1"	Comp (IPS) x Comp (IPS)		3.09	120/20
204-106	1-1/4"	Comp (IPS) x Comp (IPS)		4.04	72/12
204-107	1-1/2"	Comp (IPS) x Comp (IPS)		4.96	60/10
204-108	2"	Comp (IPS) x Comp (IPS)		6.89	50/5
204-109	2-1/2"	Comp (IPS) x Comp (IPS)		16.20	20/1
204-110	3"	Comp (IPS) x Comp (IPS)		24.63	12/1
204-111	4"	Comp (IPS) x Comp (IPS)		32.66	6/1
204-112	6"	Comp (IPS) x Comp (IPS)		61.00	6/1

Naturally lead free
ISO 9002
150 CWP @ 73°F
ANSI/NSF 61-G listed



CPVC Coupling

Long Pattern

204-123	1/2"	Comp x Comp		3.56	360/20
204-124	3/4"	Comp x Comp		5.57	240/20



COMPRESSION REPAIR FITTINGS

PVC Expansion Repair Coupling

150 CWP @ 73°F
Naturally lead free



PVC Expansion Coupling

Part No.	Size	Configuration	Model No.	List Price	Cs/Ct
204-143	1/2"	Spigot x Socket	Expansion Coupling	4.06	148/37
204-144	3/4"	Spigot x Socket	Expansion Coupling	5.02	92/23
204-145	1"	Spigot x Socket	Expansion Coupling	10.03	48/12
204-146	1-1/4"	Spigot x Socket	Expansion Coupling	12.12	64/16
204-147	1-1/2"	Spigot x Socket	Expansion Coupling	14.45	64/16
204-148	2"	Spigot x Socket	Expansion Coupling	19.65	36/9

CAST PRESSURE FITTINGS

Cast Pressure Fitting

- 1 CSA (ANSI/NSF 61-G)
- 2 Truesdail (ANSI/NSF 61-G)
- 3 NSF (ANSI/NSF 61-G)
- 4 IAPMO/UPC (ANSI/NSF 61-G)



Sweat x FNPT Drop Ear Elbow



Sweat x Sweat Drop Ear Elbow



FNPT x FNPT Drop Ear Elbow



Pex End Drop Ear Elbow



F 1960 PEX x FIP

Drop Ear Elbows

302-222	1/2" x 3/8"	Sweat x FNPT	Drop Ear Elbow	5.09	300/50
2 302-222NL	1/2" x 3/8"	Sweat x FNPT	Drop Ear Elbow	5.90	300/50
302-223	1/2" x 1/2"	Sweat x FNPT	Drop Ear Elbow	2.90	300/50
2 302-223NL	1/2" x 1/2"	Sweat x FNPT	Drop Ear Elbow	3.73	300/50
302-224	3/4" x 3/4"	Sweat x FNPT	Drop Ear Elbow	9.90	200/25
1 302-224NL	3/4" x 3/4"	Sweat x FNPT	Drop Ear Elbow	13.23	200/25
302-225	1/2"	Sweat x Sweat	Drop Ear Elbow	3.33	300/50
2 302-225NL	1/2"	Sweat x Sweat	Drop Ear Elbow	4.26	300/50
302-232	3/4"	Sweat x Sweat	Drop Ear Elbow	8.03	200/25
1 302-232NL	3/4"	Sweat x Sweat	Drop Ear Elbow	10.76	200/25
302-226	1/2"	FNPT x FNPT	Drop Ear Elbow	8.42	180/45
1 302-226NL	1/2"	FNPT x FNPT	Drop Ear Elbow	11.05	180/45
302-228	3/4"	FNPT x FNPT	Drop Ear Elbow	13.10	100/25
1 302-228NL	3/4"	FNPT x FNPT	Drop Ear Elbow	17.38	100/25

















3 Hole Drop Ear Elbows

NEW 3 302-218NL	3/8" x 1/2"	PEX x FNPT	Drop Ear Elbow	5.56	200/10
302-219	1/2"	PEX x FNPT	Drop Ear Elbow	5.25	200/10
3 302-219NL	1/2"	PEX x FNPT	Drop Ear Elbow	7.10	200/10
3 302-220NL	3/4" x 1/2"	PEX x FNPT	Drop Ear Elbow	10.42	150/10
302-221	3/4"	PEX x FNPT	Drop Ear Elbow	7.22	100/25
3 302-221NL	3/4"	PEX x FNPT	Drop Ear Elbow	10.42	100/25

F 1960 PEX x FIP 3 Hole Drop Ear Elbow

NEW 4 302-235NL	1/2"	F 1960 PEX x FNPT	Drop Ear Elbow	10.45	200/10
NEW 4 302-236NL	3/4"	F 1960 PEX x FNPT	Drop Ear Elbow	14.94	200/10

CAST PRESSURE FITTINGS

Cast Pressure Fitting (cont.)	Part No.	Size	Configuration	Model No.	List Price	Cs/Ct	
<ol style="list-style-type: none"> 1 CSA (ANSI/NSF 61-G) 2 Truesdail (ANSI/NSF 61-G) 3 NSF (ANSI/NSF 61-G) 4 IAPMO/UPC (ANSI/NSF 61-G) 	CPVC x FNPT 3 Hole Drop Ear Elbow						
		302-231	1/2"	CPVC x FNPT	Drop Ear Elbow	6.47	200/20
		302-231NL	1/2"	CPVC x FNPT	Drop Ear Elbow	8.17	200/20
		302-234	3/4"	CPVC x FNPT	Drop Ear Elbow	12.21	100/10
 <p>High Ear Elbow</p>		302-234NL	3/4"	CPVC x FNPT	Drop Ear Elbow	14.85	100/10
	 <p>CPVC x FNPT Drop Ear Elbow</p>	High Ear Elbows					
		302-229	1/2"	Sweat x FNPT	High Ear Elbow	6.95	240/60
 <p>Drain Elbow</p>	1	302-229NL	1/2"	Sweat x FNPT	High Ear Elbow	9.27	240/60
	Drain Elbows						
 <p>Sweat x MNPT Elbow</p>		302-243	3/4"	Sweat x Sweat	Drain Elbow	4.23	300/50
		302-243NL	3/4"	Sweat x Sweat	Drain Elbow	5.45	300/50
 <p>Elbow</p>	Elbows						
		302-273	1/2"	Sweat x MNPT	Elbow	4.65	400/50
 <p>Drain Elbow</p>	1	302-273NL	1/2"	Sweat x MNPT	Elbow	6.34	400/50
		302-274	3/4"	Sweat x MNPT	Elbow	7.64	300/25
 <p>Sweat x MNPT Elbow</p>	1	302-274NL	3/4"	Sweat x MNPT	Elbow	10.33	300/25
		302-275	1"	Sweat x MNPT	Elbow	14.01	160/10
 <p>Sweat x FNPT Elbow</p>	1	302-275NL	1"	Sweat x MNPT	Elbow	18.98	160/10
		302-283	1/2"	Sweat x FNPT	Elbow	5.16	300/50
 <p>Sweat x FNPT Elbow</p>	1	302-283NL	1/2"	Sweat x FNPT	Elbow	6.98	300/50
		302-284	3/4"	Sweat x FNPT	Elbow	8.15	200/25
 <p>Sweat x FNPT Elbow</p>	1	302-284NL	3/4"	Sweat x FNPT	Elbow	11.36	200/25
		302-285	1"	Sweat x FNPT	Elbow	15.89	120/10
 <p>Sweat x FNPT Elbow</p>	1	302-285NL	1"	Sweat x FNPT	Elbow	20.70	120/10
		302-291	1/2" x 3/8"	Sweat x FNPT	Elbow	4.45	400/50
 <p>Sweat x FNPT Elbow</p>	1	302-291NL	1/2" x 3/8"	Sweat x FNPT	Elbow	6.32	400/50
	Baseboard Tees						
 <p>Baseboard Tee</p>		302-252	1/2" x 1/8" x 1/2"	Sweat x FNPT x Sweat	Baseboard Tee	4.47	300/50
	1	302-252NL	1/2" x 1/8" x 1/2"	Sweat x FNPT x Sweat	Baseboard Tee	6.35	300/50
 <p>Baseboard Tee</p>		302-253	3/4" x 1/8" x 3/4"	Sweat x FNPT x Sweat	Baseboard Tee	4.24	300/50
	1	302-253NL	3/4" x 1/8" x 3/4"	Sweat x FNPT x Sweat	Baseboard Tee	6.19	300/50
 <p>Baseboard Tee</p>		302-254	1" x 1/8" x 1"	Sweat x FNPT x Sweat	Baseboard Tee	11.78	150/25
	1	302-254NL	1" x 1/8" x 1"	Sweat x FNPT x Sweat	Baseboard Tee	14.82	150/25
 <p>Baseboard Tee</p>		302-255	1-1/4" x 1/8" x 1-1/4"	Sweat x FNPT x Sweat	Baseboard Tee	15.84	100/10
	1	302-255NL	1-1/4" x 1/8" x 1-1/4"	Sweat x FNPT x Sweat	Baseboard Tee	20.08	100/10

SPECIALTY PRODUCTS



CAST PRESSURE FITTINGS

Cast Pressure Fitting (cont.)	Part No.	Size	Configuration	Model No.	List Price	Cs/Ct
<ol style="list-style-type: none"> 1 CSA (ANSI/NSF 61-G) 2 Truesdail (ANSI/NSF 61-G) 3 NSF (ANSI/NSF 61-G) 4 IAPMO/UPC (ANSI/NSF 61-G) 	Tees					
	1 302-342NL	1/2" x 3/4"	Sweat x Sweat x FNPT	Tee	11.08	25
	302-343	1/2"	Sweat x Sweat x FNPT	Tee	7.47	300/25
	1 302-343NL	1/2"	Sweat x Sweat x FNPT	Tee	8.88	300/25
	302-344	3/4"	Sweat x Sweat x FNPT	Tee	11.42	200/25
	1 302-344NL	3/4"	Sweat x Sweat x FNPT	Tee	15.23	200/25
	302-354	3/4" x 3/4" x 1/2"	Sweat x Sweat x FNPT	Tee	9.32	200/25
	1 302-354NL	3/4" x 3/4" x 1/2"	Sweat x Sweat x FNPT	Tee	12.62	200/25
	302-355	1" x 1" x 1/2"	Sweat x Sweat x FNPT	Tee	13.92	120/10
	1 302-355NL	1" x 1" x 1/2"	Sweat x Sweat x FNPT	Tee	18.92	120/10
	302-356	1" x 1" x 3/4"	Sweat x Sweat x FNPT	Tee	14.53	100/10
	1 302-356NL	1" x 1" x 3/4"	Sweat x Sweat x FNPT	Tee	19.57	100/10
	302-357	1-1/4" x 1-1/4" x 1/2"	Sweat x Sweat x FNPT	Tee	16.06	80/10
	1 302-357NL	1-1/4" x 1-1/4" x 1/2"	Sweat x Sweat x FNPT	Tee	21.97	80/10
	302-358	1-1/4" x 1-1/4" x 3/4"	Sweat x Sweat x FNPT	Tee	19.63	60/10
	1 302-358NL	1-1/4" x 1-1/4" x 3/4"	Sweat x Sweat x FNPT	Tee	23.75	60/10
	302-363	1/2"	Sweat x Sweat x MNPT	Tee	4.74	300/50
	1 302-363NL	1/2"	Sweat x Sweat x MNPT	Tee	7.88	300/50
	302-373	1/2"	Sweat x FNPT x Sweat	Tee	6.08	300/50
	1 302-373NL	1/2"	Sweat x FNPT x Sweat	Tee	8.30	300/50
	302-384	3/4" x 1/2" x 3/4"	Sweat x FNPT x Sweat	Tee	11.43	200/25
	1 302-384NL	3/4" x 1/2" x 3/4"	Sweat x FNPT x Sweat	Tee	15.77	200/25
	302-321	3/4" x 3/4" x 1/2"	FNPT x FNPT x Sweat	Tee	10.89	200/25
	1 302-321NL	3/4" x 3/4" x 1/2"	FNPT x FNPT x Sweat	Tee	14.69	200/25
	302-322	3/4" x 1/2" x 1/2"	FNPT x FNPT x Sweat	Tee	10.52	200/25
	1 302-322NL	3/4" x 1/2" x 1/2"	FNPT x FNPT x Sweat	Tee	13.97	200/25
	302-323	3/4" x 1/2" x 3/4"	FNPT x FNPT x Sweat	Tee	10.64	200/25
	1 302-323NL	3/4" x 1/2" x 3/4"	FNPT x FNPT x Sweat	Tee	15.46	200/25
	Drop Ear Tees					
	302-233	1/2"	Sweat	Drop Ear Tee	3.70	300/50
	2 302-233NL	1/2"	Sweat	Drop Ear Tee	5.03	300/50
	2 302-333NL	1/2"	PEX x PEX x FNPT	Drop Ear Tee	9.00	300/50
	NEW 2 302-334NL	3/4"	PEX x PEX x FNPT	Drop Ear Tee	15.64	300/50
	Drain Couplings					
	302-262	1/2"	Sweat	Drain Coupling	5.35	500/25
	1 302-262NL	1/2"	Sweat	Drain Coupling	6.92	500/25
	302-263	3/4"	Sweat	Drain Coupling	4.08	300/50
	2 302-263NL	3/4"	Sweat	Drain Coupling	5.19	300/50
	302-264	1"	Sweat	Drain Coupling	10.07	120/10
	1 302-264NL	1"	Sweat	Drain Coupling	13.29	120/10



Sweat x Sweat x FNPT Tee



Sweat x Sweat x MNPT Tee



Sweat x FNPT x Sweat Tee



Drop Ear Tee



Drain Coupling

CAST PRESSURE FITTINGS

Cast Pressure Fitting (cont.)

- 1 CSA (ANSI/NSF 61-G)
- 2 Truesdail (ANSI/NSF 61-G)
- 3 NSF (ANSI/NSF 61-G)
- 4 IAPMO/UPC (ANSI/NSF 61-G)

Part No.	Size	Configuration	Model No.	List Price	Cs/Ct
Wing Adapters					
302-293	1/2"	FNPT x Sweat	Wing Adapter	6.14	340/85
2 302-293NL	1/2"	FNPT x Sweat	Wing Adapter	7.81	340/85



Wing Adapter

Adapter

Adapters					
3 302-423NL	1/2"	PEX x CPVC	Adapter	5.25	400/50
3 302-424NL	3/4"	PEX x CPVC	Adapter	8.38	300/50
3 302-425NL	1"	PEX x CPVC	Adapter	14.72	200/25



Sweat x Sweat Union

Unions					
1 302-303NL	1/2"	Sweat x Sweat	Union	10.16	250/25
1 302-304NL	3/4"	Sweat x Sweat	Union	16.16	200/20
1 302-305NL	1"	Sweat x Sweat	Union	26.10	100/10
1 302-300NL	1-1/4"	Sweat x Sweat	Union	49.44	45/5
1 302-301NL	1-1/2"	Sweat x Sweat	Union	60.50	45/5
1 302-302NL	2"	Sweat x Sweat	Union	109.26	33/1



Sweat x MNPT Union

4 302-306NL	1/2"	Sweat x MNPT	Union	16.75	100/10
4 302-307NL	3/4"	Sweat x MNPT	Union	24.69	100/10
4 302-308NL	1"	Sweat x MNPT	Union	37.93	60/10
4 302-309NL	1-1/4"	Sweat x MNPT	Union	50.93	60/6
4 302-310NL	1-1/2"	Sweat x MNPT	Union	78.89	40/5
4 302-311NL	2"	Sweat x MNPT	Union	115.20	20/2



Sweat x FNPT Union

1 302-316NL	1/2"	Sweat x FNPT	Union	15.06	25
1 302-317NL	3/4"	Sweat x FNPT	Union	22.66	20
1 302-318NL	1"	Sweat x FNPT	Union	37.44	10

No Lead Brass CPVC Transition Fitting

100 CWP, max temp 180°F
ANSI/NSF 61-G, ANSI/NSF 14
ISO 9002, Third party certified Truesdail



MNPT x CPVC

NEW 302-403NL	1/2"	MNPT x CPVC	Transition Fittings	4.58	24
NEW 302-404NL	3/4"	MNPT x CPVC	Transition Fittings	6.65	30
NEW 302-405NL	1"	MNPT x CPVC	Transition Fittings	11.67	25
NEW 302-406NL	1-1/4"	MNPT x CPVC	Transition Fittings	25.51	10
NEW 302-407NL	1-1/2"	MNPT x CPVC	Transition Fittings	33.00	10
NEW 302-408NL	2"	MNPT x CPVC	Transition Fittings	47.97	5



FNPT x CPVC

NEW 302-413NL	1/2"	FNPT x CPVC	Transition Fittings	4.49	24
NEW 302-414NL	3/4"	FNPT x CPVC	Transition Fittings	5.70	30
NEW 302-415NL	1"	FNPT x CPVC	Transition Fittings	11.38	25
NEW 302-416NL	1-1/4"	FNPT x CPVC	Transition Fittings	21.15	10
NEW 302-417NL	1-1/2"	FNPT x CPVC	Transition Fittings	26.61	10
NEW 302-418NL	2"	FNPT x CPVC	Transition Fittings	45.76	5



CAST PRESSURE FITTINGS

304 Stainless Steel x CPVC Transition Fitting

100 CWP, max temp 180°F
Naturally lead free
ANSI/NSF 14
ISO 9002



MNPT x CPVC
Transition Fitting



FNPT x CPVC
Transition Fitting



PEX x FNPT
Drop Ear Elbow

Part No.	Size	Configuration	Model No.	List Price	Cs/Ct
302-433	1/2"	MNPT x CPVC	Adapter	4.64	250/25
302-434	3/4"	MNPT x CPVC	Adapter	6.36	250/25
302-435	1"	MNPT x CPVC	Adapter	11.08	150/25
302-436	1-1/4"	MNPT x CPVC	Adapter	21.58	80/10
302-437	1-1/2"	MNPT x CPVC	Adapter	31.11	60/10
302-438	2"	MNPT x CPVC	Adapter	38.03	20/5
302-443	1/2"	FNPT x CPVC	Adapter	4.64	250/25
302-444	3/4"	FNPT x CPVC	Adapter	6.36	250/25
302-445	1"	FNPT x CPVC	Adapter	11.08	150/25
302-446	1-1/4"	FNPT x CPVC	Adapter	21.58	80/10
302-447	1-1/2"	FNPT x CPVC	Adapter	31.11	60/10
302-448	2"	FNPT x CPVC	Adapter	38.03	20/5
Drop Ear Elbow					
302-238	1/2"	CPVC x FNPT	Drop Ear Elbow	7.89	200/10

SPECIALTY BRASS FITTINGS

Raised Square Head Plug

Southern Code
<10 psi (DWW) CWP



Raised Square Head Plug

302-603	1-1/4"	MNPT		3.19	500/100
302-604	1-1/2"	MNPT		3.99	400/100
302-605	2"	MNPT		5.17	200/100
302-606	2-1/2"	MNPT		6.20	200/50
302-607	3"	MNPT		8.45	160/20
302-608	3-1/2"	MNPT		12.07	120/20
302-609	4"	MNPT		13.18	90/15
302-610	5"	MNPT		21.93	60/10
302-611	6"	MNPT		35.84	40/10

Countersunk Plug

Southern Code
<10 psi (DWW) CWP

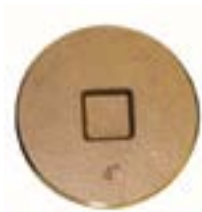

Countersunk Plug

302-624	1-1/2"	MNPT		4.55	400/100
302-625	2"	MNPT		6.49	200/50
302-626	2-1/2"	MNPT		6.71	200/50
302-627	3"	MNPT		8.89	160/20
302-628	3-1/2"	MNPT		11.40	120/20
302-629	4"	MNPT		12.55	90/15
302-630	5"	MNPT		26.90	60/10
302-635	5-1/2"	MNPT		37.58	20/10
302-631	6"	MNPT		40.01	40/10
302-632	8"	MNPT		76.06	20/5

SPECIALTY BRASS FITTINGS

Brass Trap Connector	Part No.	Size	Configuration	Model No.	List Price	Cs/Ct
With chrome plated die cast nut MNPT end ID machined for copper sweat installation  Trap Connector	302-106	1-1/4" x 1-1/4"	Slip x MNPT		9.19	200/20
	302-107	1-1/4" x 1-1/2"	Slip x MNPT		9.96	200/20
	302-108	1-1/2" x 1-1/2"	Slip x MNPT		10.77	200/20
	302-116	1-1/4" x 1-1/4"	Slip x FNPT		9.19	200/20
	302-117	1-1/4" x 1-1/2"	Slip x FNPT		9.96	200/20
	302-118	1-1/2" x 1-1/2"	Slip x FNPT		10.77	200/20

BRASS FIRE HOSE FITTINGS

Female x Male Brass Hydrant Adapter	Part No.	Size	Configuration	Model No.	List Price	Cs/Ct
Forged brass Female NYFD thread pattern Male garden hose  A-75	322-729	1-1/2" x 3/4"	NST x MGHT	A-75	19.80	100/-
	322-731	2-1/2" x 3/4"	NST x MGHT	A-75	32.04	40/-
	322-744	2-1/2" x 2"	NST x NPSH	A-75	31.25	40/-
	322-750	3" x 2-1/2"	NST x NST	A-75	75.15	20/-
	322-733	2-1/2" x 3/4"	NST x MNPT	A-75	28.82	40/-
	322-734	2-1/2" x 1"	NST x MNPT	A-75	28.82	40/-
	322-736	2-1/2" x 1-1/2"	NST x MNPT	A-75	28.82	40/-
	322-740	2-1/2" x 2"	NST x MNPT	A-75	30.00	40/-
	322-751	3" x 2-1/2"	NPSH x NST	A-75	75.15	20/-
	322-730	2-1/2" x 3/4"	NYFD x MGHT	A-75	40.36	50/-



Double Male Hex Nipple	Part No.	Size	Configuration	Model No.	List Price	Cs/Ct
Forged brass  A-92	322-510	1" x 3/4"	NPT x MGHT	A-92	19.08	200/-
	322-526	2" x 2"	NPT x NPSH	A-92	43.20	50/-
	322-511	1" x 1"	NPT x NST	A-92	19.45	100/-
	322-521	1-1/2" x 1-1/2"	NPT x NST	A-92	17.00	100/-
	322-533	2" x 2-1/2"	NPT x NST	A-92	35.00	30/-
	322-534	2-1/2" x 2-1/2"	NPT x NST	A-92	61.00	25/-
	322-523	1-1/2" x 1-1/2"	NST x NST	A-92	25.55	100/-

Female x Male Hex Nipple	Part No.	Size	Configuration	Model No.	List Price	Cs/Ct
Forged brass  A-93	322-602	1" x 3/4"	NPT x MGHT	A-93	12.35	200/-
	322-611	1-1/2" x 1-1/2"	NPT x NST	A-93	19.74	200/-
	322-634	2-1/2" x 2-1/2"	NPT x NST	A-93	56.58	20/-
	322-644	1-1/2" x 1-1/2"	NST x NPT	A-93	16.91	100/-
	322-653	2-1/2" x 2"	NST x NPT	A-93	53.65	20/-
	322-664	2-1/2" x 2-1/2"	NST x NPT	A-93	37.00	20/-
	322-612	1-1/2" x 1-1/2"	NPT x NPSH	A-93	17.50	100/-
	322-614	1-1/2" x 1-1/2"	NPSH x NPT	A-93	25.70	100/-
	322-615	1-1/2" x 1-1/2"	NPSH x NST	A-93	25.70	100/-

SPECIALTY PRODUCTS



BRASS FIRE HOSE FITTINGS

Female x Male Swivel Adapter		Part No.	Size	Configuration	Model No.	List Price	Cs/Ct
Forged brass All sizes with ball bearing swivel							
 <p>A-91</p>		322-201	1-1/2" x 1-1/2"	NST x NPT	A-91	87.97	50/-
		322-233	2-1/2" x 2"	NST x NPT	A-91	68.30	10/-
		322-234	2-1/2" x 2-1/2"	NST x NPT	A-91	122.57	10/-
		322-235	2-1/2" x 3"	NST x NPT	A-91	125.10	10/-
Caps & Plugs with Chain							
Forged brass							
 <p>A-80</p>		Caps (Female)					
		324-101	1-1/2"	NST	A-80	14.25	100/-
 <p>A-81</p>		324-103	2-1/2"	NST	A-80	30.00	50/-
		Plugs (Male)					
		324-123	2-1/2"	NST	A-81	45.40	50/-

GHT - Garden Hose Thread

NH (NST) - National Hose Thread or National Standard Thread

NPT - National Pipe Tapered Thread

NPSH - National Pipe Straight Hose Thread

Did you know? Legend customer service representatives are knowledgeable and empowered.

BRONZE HEATING AND RADIATOR VALVES

Steam Angle Radiator Valve

ISO 9002 (T-431 only), 15 psi
Cast bronze



T-431

Part No.	Size	Configuration	Model No.	List Price	Cs/Ct
110-103	1/2"	FNPT x MNPT	T-431	25.82	60/10
110-104	3/4"	FNPT x MNPT	T-431	33.40	48/8
110-105	1"	FNPT x MNPT	T-431	43.66	36/6
110-106	1-1/4"	FNPT x MNPT	T-431	61.96	24/4
110-107	1-1/2"	FNPT x MNPT	T-431	94.05	18/3
110-108	2"	FNPT x MNPT	T-431	154.11	12/2



T-431YB

Yellow Brass

NEW

NEW

110-143	1/2"	FNPT x MNPT	T-431YB	22.49	60/10
110-147	3/4"	FNPT x MNPT	T-431YB	27.71	48/8
110-148	1"	FNPT x MNPT	T-431YB	36.94	36/6
110-149	1-1/4"	FNPT x MNPT	T-431YB	50.41	24/4
110-150	1-1/2"	FNPT x MNPT	T-431YB	58.32	16/1
110-151	2"	FNPT x MNPT	T-431YB	99.45	12/1

Hot Water Angle Valve

ISO 9002, 60 psi
Cast bronze



S-437



T-437

110-113	1/2"	FNPT x MNPT	T-437	19.30	70/7
110-114	3/4"	FNPT x MNPT	T-437	23.75	70/7
110-115*	1"	FNPT x MNPT	T-437	39.92	36/6
110-116*	1-1/4"	FNPT x MNPT	T-437	56.58	24/4
110-117*	1-1/2"	FNPT x MNPT	T-437	89.30	18/3

* 1", 1-1/4" & 1-1/2" are steam angle valves drilled for hot water use

110-123	1/2"	Sweat x MNPT	S-437	19.30	70/7
110-124	3/4"	Sweat x MNPT	S-437	23.75	70/7

Radiator Gate Valve

ISO 9002 (T-435 only), 200 CWP, 125 WSP
Cast bronze



T-435

110-133	1/2"	FNPT x MNPT	T-435	37.99	60/10
110-134	3/4"	FNPT x MNPT	T-435	49.42	48/8
110-135	1"	FNPT x MNPT	T-435	65.45	36/6
110-136	1-1/4"	FNPT x MNPT	T-435	94.99	24/4
110-137	1-1/2"	FNPT x MNPT	T-435	135.01	18/3









Yellow Brass



T-435YB

110-243	1/2"	FNPT x MNPT	T-435YB	22.80	60/10
110-244	3/4"	FNPT x MNPT	T-435YB	31.75	48/8
110-245	1"	FNPT x MNPT	T-435YB	44.02	36/6
110-246	1-1/4"	FNPT x MNPT	T-435YB	67.77	24/2
110-247	1-1/2"	FNPT x MNPT	T-435YB	81.86	16/2

BRONZE HEATING AND RADIATOR VALVES

Convactor Steam Angle Valve		Part No.	Size	Configuration	Model No.	List Price	Cs/Ct
ISO 9002 (T-433 only), 15 WSP Cast bronze		110-145	1"	FNPT	T-433	56.88	36/6
		110-146	1-1/4"	FNPT	T-433	74.10	24/4
		Yellow Brass					
T-433YB		110-125	1"	FNPT	T-433YB	43.04	36/4
		110-126	1-1/4"	FNPT	T-433YB	56.62	24/2
Union Elbow							
15 WSP, 60 psi Cast bronze		110-163	1/2"	FNPT	T-438	10.93	150/10
		110-164	3/4"	FNPT	T-438	14.20	100/10
		110-168	1"	FNPT	T-438	31.34	70/7
S-438		110-169	1-1/4"	FNPT	T-438	47.40	50/5
		110-165	1/2"	Sweat	S-438	10.93	150/10
		110-166	3/4"	Sweat	S-438	14.20	100/10
Purge & Balancing Valve							
80 CWP		110-404	3/4"	Sweat x Sweat	S-464	19.94	108/18
		110-405	1"	Sweat x Sweat	S-464	26.22	72/12
S-464		110-406	1-1/4"	Sweat x Sweat	S-464	36.23	60/10
Balancing Valve							
400 CWP, 150 WSP		110-153	1/2"	Sweat x Sweat	S-439	12.84	120/10
		110-154	3/4"	Sweat x Sweat	S-439	17.77	90/10
S-439		110-155	1"	Sweat x Sweat	S-439	25.97	60/6
		<i>Ball valve with screwdriver slot 100% shut-off</i>					
Straight Circulator Valve							
ISO 9002, 400 CWP, 150 WSP		110-213	1/2"	FNPT x FNPT	T-425	34.94	80/10
		110-214	3/4"	FNPT x FNPT	T-425	47.55	40/5
		110-217	1/2"	Sweat x Sweat	S-425	34.94	80/10
S-425		110-218	3/4"	Sweat x Sweat	S-425	47.55	40/5
Radiator Valve Handle							
		110-170*		Replacement Handle		1.65	- / -
Replacement Handle		<i>*Fits all sizes of radiator valves</i>					

HEATING SPECIALTIES

Isolation Ball Valve - Flanged		Part No.	Size	Configuration	Model No.	List Price	Cs/Ct
Forged brass ISO 9002, 600 CWP Bolt set included T-1002FLG S-1002FLG		101-074	3/4"	FNPT x Flange	T-1002FLG	34.28	36/6
		101-075	1"	FNPT x Flange	T-1002FLG	36.96	32/4
		101-076	1-1/4"	FNPT x Flange	T-1002FLG	46.88	24/4
		101-094	3/4"	Sweat x Flange	S-1002FLG	34.28	36/6
		101-095	1"	Sweat x Flange	S-1002FLG	36.96	32/4
		101-096	1-1/4"	Sweat x Flange	S-1002FLG	46.88	24/4

Isolation Ball Valve - Rotating Flange		Part No.	Size	Configuration	Model No.	List Price	Cs/Ct
Forged brass ISO 9002, 600 CWP Bolt set included T-2011RFLG S-2011RFLG P-2011		101-274	3/4"	FNPT x Flange	T-2011RFLG	39.99	24/1
		101-275	1"	FNPT x Flange	T-2011RFLG	46.11	18/1
		101-276	1-1/4"	FNPT x Flange	T-2011RFLG	58.56	12/1
		101-294	3/4"	Sweat x Flange	S-2011RFLG	39.99	24/1
		101-295	1"	Sweat x Flange	S-2011RFLG	46.11	18/1
		101-296	1-1/4"	Sweat x Flange	S-2011RFLG	58.56	12/1
		NEW 101-284	1/2"	Press x Flange	P-2011	44.43	24/1
		NEW 101-285	3/4"	Press x Flange	P-2011	51.23	18/1
		NEW 101-286	1"	Press x Flange	P-2011	65.07	12/1
				<i>Rotating flange for greater installation ease</i>			

Isolation Ball Valve - Rotating Flange & Purge		Part No.	Size	Configuration	Model No.	List Price	Cs/Ct
Forged brass ISO 9002, 600 CWP Bolt set included T-2012RFLG S-2012RFLG		101-174	3/4"	FNPT x Flange	T-2012RFLG	44.34	24/1
		101-175	1"	FNPT x Flange	T-2012RFLG	52.41	18/1
		101-176	1-1/4"	FNPT x Flange	T-2012RFLG	66.71	12/1
		101-194	3/4"	Sweat x Flange	S-2012RFLG	44.34	24/1
		101-195	1"	Sweat x Flange	S-2012RFLG	52.41	18/1
		101-196	1-1/4"	Sweat x Flange	S-2012RFLG	66.71	12/1
				<i>Rotating flange for greater installation ease. Purge feature saves system down time.</i>			

Tankless Water Heater Valve Kit		Part No.	Size	Configuration	Model No.	List Price	Cs/Ct
Traditional & no lead forged brass ANSI/NSF 61-G (NL only) 600 CWP Tankless Water Heater Valve		Pair without PRV					
		101-150	3/4"	FNPT Union x FNPT		94.63	16/1
		101-150NL	3/4"	FNPT Union x FNPT		125.99	16/1
		101-156	1"	FNPT Union x FNPT		167.99	- / -
		101-156NL	1"	FNPT Union x FNPT		206.97	- / -

HEATING SPECIALTIES

Tankless Water Heater Valve Kit (cont.)



Pair with 200K BTU
PRV



Tankless Water
Heater Valve



200K
BTU PRV

Part No.	Size	Configuration	Model No.	List Price	Cs/Ct
101-151	3/4"	FNPT Union x Sweat		94.63	16/1
101-151NL	3/4"	FNPT Union x Sweat		125.99	16/1
101-157	1"	FNPT Union x Sweat		167.99	- / -
101-157NL	1"	FNPT Union x Sweat		206.97	- / -

Pair with 200K BTU PRV Factory Set at 150 PSI

101-149	3/4"	FNPT Union x FNPT		116.63	16/1
101-149NL	3/4"	FNPT Union x FNPT		162.49	16/1
101-155	1"	FNPT Union x FNPT		187.62	- / -
101-155NL	1"	FNPT Union x FNPT		245.90	- / -

Pair with 200K BTU PRV Factory Set 150 PSI

101-154	3/4"	FNPT Union x Sweat		116.63	16/1
101-154NL	3/4"	FNPT Union x Sweat		162.49	16/1
101-160	1"	FNPT Union x Sweat		187.62	- / -
101-160NL	1"	FNPT Union x Sweat		245.90	- / -

Pair with 2.7 Million PRV BTU Factory Set 150 PSI

101-152	3/4"	FNPT Union x FNPT		196.67	- / -
101-152NL	3/4"	FNPT Union x FNPT		254.93	- / -
101-158	1"	FNPT Union x FNPT		273.20	- / -
101-158NL	1"	FNPT Union x FNPT		339.99	- / -

Pair with 2.7 Million PRV BTU Factory Set 150 PSI

101-153	3/4"	FNPT Union x Sweat		196.67	- / -
101-153NL	3/4"	FNPT Union x Sweat		254.93	- / -
101-159	1"	FNPT Union x Sweat		273.20	- / -
101-159NL	1"	FNPT Union x Sweat		339.99	- / -

2.7 Million BTU PRV

111-300	3/4"	MNPT	3/4" - 1" 2.7 BTU	82.74	- / -
111-300NL	3/4"	MNPT	3/4" - 1" 2.7 BTU	101.67	- / -

200K BTU PRV

111-301	3/4"	MNPT	3/4" - 1" 200K BTU	15.44	- / -
111-301NL	3/4"	MNPT	3/4" - 1" 200K BTU	29.09	- / -

Oil Tank Valve



T-566

Ball Type

111-205	1/2" x 3/8"	MNPT x MNPT	T-565	25.36	72/6
111-206*	1/2" x 3/8"	MNPT x Flare	T-566	26.27	72/6

*Includes flare nut

HEATING AIR VENTS

Chrome Plated Steam Air Vent	Part No.	Size	Configuration	Model No.	List Price	Cs/Ct
ISO 9002						
	Angle					
	110-301	1/8"	MNPT	T-60	20.28	72/12
	Adjustable					
	110-305	1/8"	MNPT	T-60A	32.33	72/12
	Straight					
	110-302	1/8"	MNPT	T-61	27.32	72/12
	110-303	1/4"	MNPT	T-63	28.90	72/12
	110-304	3/4" x 1/2"	MNPT / FNPT	T-65	33.73	72/12

Chrome Plated Economy Series	Part No.	Size	Configuration	Model No.	List Price	Cs/Ct
ISO 9002						
	Angle					
	110-321	1/8"	MNPT	T-90	9.69	144/12
	Adjustable					
	110-325	1/8"	MNPT	T-90A	10.74	144/12
	Straight					
	110-322	1/8"	MNPT	T-91	9.69	144/12
	110-323	1/4"	MNPT	T-93	11.25	144/12
	110-324	3/4" x 1/2"	MNPT / FNPT	T-95	12.00	144/12

Automatic Hot Water Air Vent	Part No.	Size	Configuration	Model No.	List Price	Cs/Ct
ISO 9002 200 psi Max temp 200°F						
	110-331	1/8"	MNPT	T-70	13.78	100/10
	110-332	1/4"	MNPT	T-70	12.79	100/10

T-70H High Capacity Auto Air Vent	Part No.	Size	Configuration	Model No.	List Price	Cs/Ct
ISO 9002 100 psi Max service temp 248° F Serviceable						
	110-333	3/8"	MNPT	T-70H	21.88	100/10

Automatic Air Vent	Part No.	Size	Configuration	Model No.	List Price	Cs/Ct
ISO 9002 125 psi Max temp 240°F						
	110-350	1/8"	MNPT	T-73	11.49	500/50
	110-351	1/4"	MNPT	T-73	11.35	500/50

HEATING VALVES

HEATING AIR VENTS

Manual Adjustable Air Vent

ISO 9002
100 psi
Max temp 200°F



T-75

Part No.	Size	Configuration	Model No.	List Price	Cs/Ct
110-337	1/8"	MNPT	T-75	3.75	1000/50

Coin Key Air Vent

ISO 9002
125 psi
Max temp 200°F



Key for T-77



T-77

110-338	1/8"	MNPT	T-77	1.90	1000/100
110-340				0.78	- / -

Key for T-77

Air Purger

125 CWP
Max temp 275°F



T-80

NEW

110-345	1"	FNPT	T-80	23.27	12/1
110-346	1-1/4"	FNPT	T-80	23.27	12/1
110-347	1-1/2"	FNPT	T-80	51.10	- / -
110-348	2"	FNPT	T-80	54.44	6/1

HEATING SPECIALTIES

Gauge

ISO 9001
0-75 psi



T-825
Bottom Mount



T-825
Rear Mount

Rear Mount Temperature & Pressure Gauge (40 - 200°F)

800-662	1/4"	MNPT	T-825	29.00	60/1
800-663	1/2"	MNPT	T-825	30.00	60/1

Rear Mount Temperature & Pressure Gauge (60 - 280°F)

800-673	1/2"	MNPT	T-825	31.00	60/1
---------	------	------	-------	-------	------

Bottom Mount Temperature & Pressure Gauge (40 - 200°F)

800-664	1/4"	MNPT	T-825	29.00	60/1
800-665	1/2"	MNPT	T-825	31.50	60/1

Bottom Mount Temperature & Pressure Gauge (60 - 280°F)

800-675	1/2"	MNPT	T-825	31.00	60/1
---------	------	------	-------	-------	------



T-825
Bottom Mount Extended



T-825
Rear Mount Extended

Rear Mount Extended Probe T & P Gauge (60 - 280°F)

800-683	1/2", 3" Probe	MNPT	T-825	31.00	60/1
---------	----------------	------	-------	-------	------

Bottom Mount Extended Probe T & P Gauge (60 - 280°F)

800-684	1/2", 3" Probe	MNPT	T-825	31.00	60/1
---------	----------------	------	-------	-------	------



T-825
2-1/2" Rear Mount

2-1/2" Rear Mount Temperature & Pressure Gauge (60 - 280°F)





800-692	1/4"	MNPT	T-825	23.00	60/1
800-693	1/2"	MNPT	T-825	25.00	60/1

2-1/2" gauge is ideal for boiler replacements

HEATING SPECIALTIES

Gauge (cont.)	Part No.	Size	Configuration	Model No.	List Price	Cs/Ct
ISO 9001 0-75 psi						
 <p>2" Temperature Gauge</p>						
		2" Temperature Gauge with Thermowell (60 - 280°F)				
	800-653	1/2", 1" Probe	MNPT		18.90	60/1
		3" Temperature Gauge with Thermowell (60 - 280°F)				
	800-652	1/2", 1" Probe	MNPT		21.00	60/1
		2" Temperature Gauge with Thermowell (60 - 280°F)				
	800-655	3/4", 1" Probe	Sweat		21.00	60/1
		3" Temperature Gauge with Thermowell (60 - 280°F)				
	800-654	3/4", 1" Probe	Sweat		21.99	60/1

Carbon Steel Boiler Manifold Header

 <p>2 Zone</p>	NEW	355-392	1" x 3/4"	2 Zone	Manifold	44.17	6/1
		355-402	1-1/4" x 3/4"	2 Zone	Manifold	26.99	- / -
		355-412	1-1/4" x 1"	2 Zone	Manifold	29.44	- / -
		355-422	1-1/2" x 3/4"	2 Zone	Manifold	44.77	- / -
		355-432	1-1/2" x 1"	2 Zone	Manifold	45.26	- / -
 <p>3 Zone</p>	NEW	355-393	1" x 3/4"	3 Zone	Manifold	47.92	8/1
		355-403	1-1/4" x 3/4"	3 Zone	Manifold	38.33	- / -
		355-413	1-1/4" x 1"	3 Zone	Manifold	41.67	- / -
		355-423	1-1/2" x 3/4"	3 Zone	Manifold	48.23	- / -
		355-433	1-1/2" x 1"	3 Zone	Manifold	49.28	- / -
 <p>4 Zone</p>	NEW	355-394	1" x 3/4"	4 Zone	Manifold	65.17	8/1
		355-404	1-1/4" x 3/4"	4 Zone	Manifold	50.42	- / -
		355-414	1-1/4" x 1"	4 Zone	Manifold	54.89	- / -
		355-424	1-1/2" x 3/4"	4 Zone	Manifold	59.64	- / -
		355-434	1-1/2" x 1"	4 Zone	Manifold	74.34	- / -
	NEW	355-442	1-1/4" x (3) 3/4" & (1) 1"	4 Zone	Manifold	53.99	9/1-
 <p>5 Zone</p>	NEW	355-405	1-1/4" x 3/4"	5 Zone	Manifold	87.72	6/1
	NEW	355-415	1-1/4" x 1"	5 Zone	Manifold	91.61	5/1
	NEW	355-425	1-1/2" x 3/4"	5 Zone	Manifold	103.33	5/1
	NEW	355-435	1-1/2" x 1"	5 Zone	Manifold	117.22	5/1
 <p>6 Zone</p>	NEW	355-406	1-1/4" x 3/4"	6 Zone	Manifold	103.44	5/1
	NEW	355-416	1-1/4" x 1"	6 Zone	Manifold	123.03	5/1
	NEW	355-426	1-1/2" x 3/4"	6 Zone	Manifold	127.50	4/1
	NEW	355-436	1-1/2" x 1"	6 Zone	Manifold	137.50	4/1

HEATING SPECIALTIES

Mono-Flow Tee

Traditional & no lead brass
ANSI/NSF 372 (NL only)



T-570

Part No.	Size	Configuration	Model No.	List Price	Cs/Ct
302-203	3/4" x 1/2"	Sweat	T-570	9.00	160/40
302-203NL	3/4" x 1/2"	Sweat	T-570NL	10.59	160/40
302-204	1" x 1/2"	Sweat	T-570	11.77	100/25
302-204NL	1" x 1/2"	Sweat	T-570NL	14.99	100/25
302-205	1" x 3/4"	Sweat	T-570	13.90	100/25
302-205NL	1" x 3/4"	Sweat	T-570NL	16.09	100/25
302-206	1-1/4" x 1/2"	Sweat	T-570	14.52	80/20
302-206NL	1-1/4" x 1/2"	Sweat	T-570NL	16.23	80/20
302-207	1-1/4" x 3/4"	Sweat	T-570	16.35	80/20
302-207NL	1-1/4" x 3/4"	Sweat	T-570NL	19.99	80/20

Venturi Tee

Traditional brass



T-569

302-213	3/4" x 1/2"	Sweat	T-569	9.53	160/40
302-214	1" x 1/2"	Sweat	T-569	13.89	100/25
302-215	1" x 3/4"	Sweat	T-569	14.96	100/25
302-216	1-1/4" x 1/2"	Sweat	T-569	17.69	80/20
302-217	1-1/4" x 3/4"	Sweat	T-569	18.44	80/20

Did you know? Always a human means that when you call Legend you will talk to a person.



Legend has a comprehensive offering of radiant flooring products, heating tube, manifolds, and mechanical room components for residential and commercial hydronic systems. From the mechanical room to the radiant panel, Legend has feature rich products designed to deliver efficiencies in both design and operation. Backed by a team of engineers, Legend offers on-demand technical and design support to assist you with your project.



VersaTherm™

snap-fit floor system

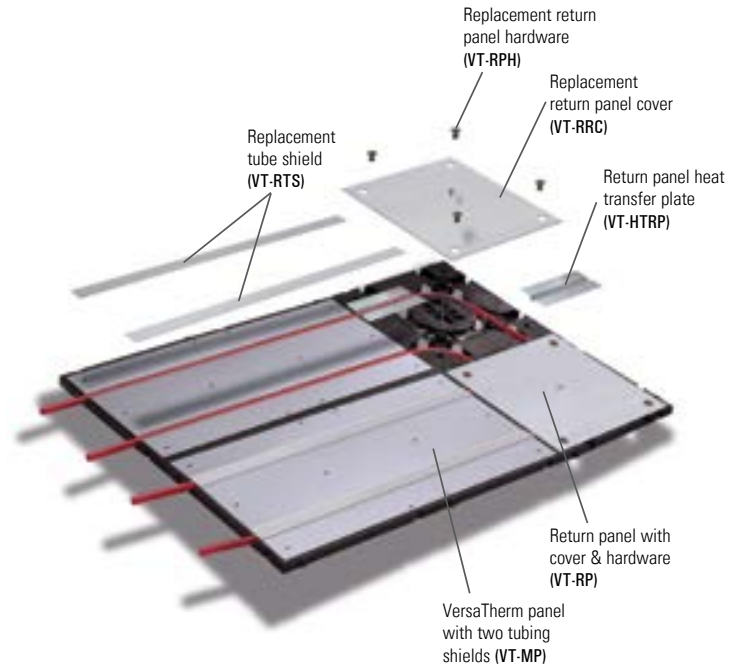

The innovative VersaTherm™ floor system is unlike any dry radiant system on the market. The panels snap together in minutes saving significant labor costs. Basement and 2nd floor retrofits are easy because the panels are pre-insulated and naturally water resistant. The use of 1/2" pipe allows for greater circuit lengths and is 100% protected by metal, unlike many other dry systems. Thus, the entire surface transfers heat, reducing temperature stratification common in some systems. The panels are only 3/4" thick, minimizing construction problems common in over-pour installations.

- Labor saving – snaps together
- 1/2" pipe – for longer circuit lengths
- Tubing is protected against damage
- Return Panels are pre-insulated – great for retrofits and basements
- Naturally water resistant
- Entire surface transfers heat
- Return Panels are easily cut for tight installations
- Tube spacing is 8" on center





Material worksheet on page 148

VERSATHERM™ PANELS

Main Panel	Part No.	Size	Configuration	Model No.	List Price	Qty.	Case
Includes 2 tube shields	VT-MP	31-1/2" x 15-3/4" x 3/4"	Main Panel	VersaTherm	40.95	1	10
							
Return Panel							
Includes return panel cover (VT-RRC) Return panel hardware (VT-RPH) (2) Return panel heat transfer plate (VT-HTRP)	VT-RP	15-3/4" x 15-3/4" x 3/4"	Return Panel	VersaTherm	20.48	1	20
							
Replacement Tube Shield							
Used with main panel to protect tubing from damage	VT-RTS	31-1/2" x 1-3/8"	Replacement Tube Shield	VersaTherm	3.00	1	3
							

VERSATHERM™ ACCESSORIES

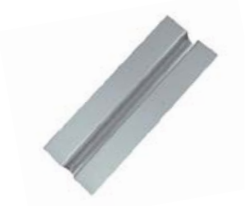
Replacement Return Panel Cover		Part No.	Size	Configuration	Model No.	List Price	Qty.	Case
Used with return panel to protect tubing from damage.		VT-RRC	15-3/4" x 15-3/4"	Repl Return Cover	VersaTherm	16.00	1	-
								
Replacement Return Panel Hardware		Used to Fasten Return Panel Cover						
Includes 4 plastic snap rivets and 1 screw		VT-RPH		Return Hardware	VersaTherm	3.00	1	-
								
Filler Panels		VT-SM	2" x 15-3/4"	Small Filler	VersaTherm	4.00	1	-
Used to fill non-active space along floor edges and around obstructions		VT-LF	7-7/8" x 15-3/4"	Large Filler	VersaTherm	6.00	1	-
		<p><i>Non-active space can also be filled with standard 3/4" plywood</i></p>						
Return Panel Heat Transfer Plate - Pair		VT-HTRP	7-3/4" x 2-7/8"	Transfer Plate	VersaTherm	3.00	2	-
Optional plate increases heat output on return panel								

Did you know? Legend has an engineering laboratory for product design and development.

QuickTherm™

radiant installation panels

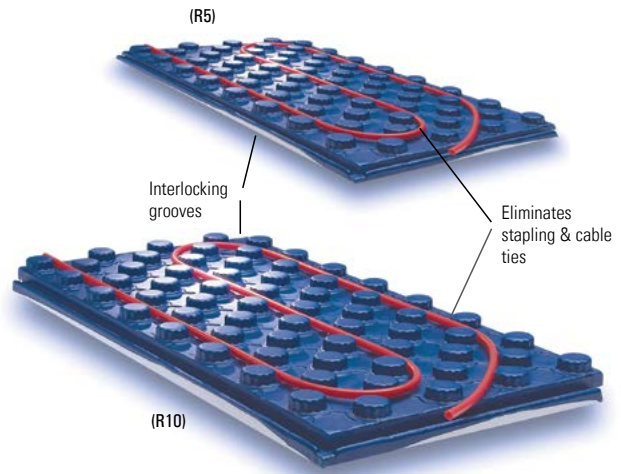

QuickTherm™ panels reduce labor costs by making it easy to properly install radiant tubing. There's no need to tie, clip, or staple tubing to the substrate.

- One person can quickly put down the panels and install the tubing while walking upright!
- The tube is better protected than in a wire mesh install
- Labor saving - installs 75% faster
- No bending or crawling
- Available in R-5, R-10 or R-11 thicknesses
- Eliminates stapling and cable ties
- 2' x 4' panels are more accommodating to uneven gravel base and subbase surfaces
- 1/2", 5/8" or 3/4" radiant tubing can be used with QuickTherm
- QuickTherm panels can reduce installation time by up to 75%. 1,000 feet of tubing installs in just a few hours
- QuickTherm panels can be drop shipped directly to the job site. Call for LTL or truck-load discount. Allow up to 3 weeks for delivery.



Material worksheet on page 148

QUICKTHERM™ PANELS

QuickTherm™ Panels	Part No.	Size	Model No.	List Price	Qty.	Case
	800-QT100R	1" thick (R-5), 2' x 4', 6" & 12" Tube Spacing (1/2" & 5/8" tubing only)	Residential	Special order only Call for quote		
	800-QT100	1" thick (R-5), 2' x 4', 6", 9", 12" Tube Spacing	QuickTherm	32.55	1	18
	800-QT200	2" thick (R-10), 2' x 4' 6", 9", 12" Tube Spacing	QuickTherm	38.85	1	10
	800-QT300	3" thick (R-11), 2' x 4', 6", 9", 12" Tube Spacing	QuickTherm	Special order only Call for quote		

TUBING INSTALLATION ACCESSORIES

Tube Holding Pins







Large diameter tube holder pins

Designed to be manually inserted into QuickTherm "knobs" to hold down large diameter tube (typ. 3/4") in tough spots where additional support may be needed. Works on all sizes of tube and all models (thicknesses) of QuickTherm.



800-349	All tube sizes for QT-100, 200, & 300	Holding Pins	46.00	100	Bag
---------	---------------------------------------	--------------	-------	-----	-----

TUBING INSTALLATION ACCESSORIES

Tube Holding Pins	Part No.	Size	Configuration	Model No.	List Price	Qty.	Case
Heavy duty tube holder pins							
	800-345	1-1/2" long for panels 1" or thicker		Holding Pins	27.90	100	Bag
	800-348	2" long for panels 1-1/2" or thicker		Holding Pins	32.02	100	Bag
<hr/>							
Tube Bend Support							
Tube bend support 90°			Holds tube in a tight radius 90° bend without a fitting elbow and without fear of "kinking." Slide support easily around 1/2" tube while straight, then make bend by clicking tabs together.				
	800-503	For 1/2" tubing		Tube Support	5.25	1	-
<hr/>							
Tube Bend Support							
Tube bend support 90°			Used to hold flexible tubing in a 90° bend without a fitting elbow and creates a neat, professional appearance.				
	800-305	Fits up to 1/2" tubing		Bend Support	7.16	1	-
	800-304	Fits up to 3/4" tubing		Bend Support	8.78	1	-
<hr/>							
Protection Sleeve							
Tube protection sleeve			Used to protect tubing in a concrete slab at expansion joints. Pre-slit 12" lengths allow for rapid installation after tubing has been installed and before concrete pour.				
	800-313	12" long	Fits 1/2" tubing	Sleeve	1.54	1	-
	800-314	12" long	Fits 3/4" tubing	Sleeve	1.82	1	-
<hr/>							
Heat Transfer Plate							
Joist space			Extruded Aluminum Heat Transfer Plates – For use in radiant floor heating via joist space applications (under sub-floor) with 3/8" or 1/2" PEX tubing. Plates are 3-1/2" x 4' long and pre-drilled for wood screws to attach underneath sub-floor. PEX tubing is held securely in tube channel on under side of plate.				
	800-362	3-1/2" x 4' long	Fits 3/8" tubing	Transfer Plate	16.50	1	20
	800-364	3-1/2" x 4' long	Fits 1/2" tubing	Transfer Plate	17.50	1	20

TUBING INSTALLATION ACCESSORIES

Tube Track	Part No.	Size	Configuration	Model No.	List Price	Qty.	Case
------------	----------	------	---------------	-----------	------------	------	------



Tube Track & Tube Track Duo – Used to hold tubing to rigid foam, wood or concrete. Mounting holes are provided for appropriate fasteners. Clips at end of each piece allow 3-1/4' (39") sections to snap together. Use tube holding pins (top) in rigid foam board installations.

800-323	39" Length	Tube track holding tabs for 3/8" or 1/2" tubing are spaced every 2"			7.87	1	-
800-324	39" Length	Dual track holding tabs for 3/8" or 1/2" and for 5/8" or 3/4" tubing alternate every 4"			9.14	1	-

Mounting Rail

Use tube holding pins (top) in rigid foam board installations



Tube Mounting Rail – Used to hold tubing to rigid foam, wood or concrete. Mounting holes are provided for appropriate fasteners. 6-1/2' (78") rails have prescored "break" lines should shorter lengths be needed. Holding slots are spaced every 2".

800-333	78" Length	Fits 1/2" tubing			12.39	1	-
800-334	78" Length	Fits 3/4" tubing			14.14	1	-

Tube Bend Support, Plastic

Bend support made from durable plastic with nail tab for securing to studs or joists when routing plastic tubing in plumbing installations. For 1/2", 3/4" and 1" tubing.

509-003	1/2"	Plastic Bend Support with Nail Tab			1.24	1	-
509-004	3/4"	Plastic Bend Support with Nail Tab			3.03	1	-
509-005	1"	Plastic Bend Support with Nail Tab			5.53	1	-

Tube Bend Support, Metal



Metal bend support for 1/2", 3/4" and 1" flexible plastic tubing.

509-013	1/2"	Metal Bend Support			1.93	1	-
509-014	3/4"	Metal Bend Support			2.89	1	-
509-023	1/2"	Metal Bend Support with Nail Flange			3.25	1	-

TUBING INSTALLATION ACCESSORIES

Tube Talon Fasteners	Part No.	Size	Configuration	Model No.	List Price	Qty.	Case
	Plastic talon hook with nail included, secures tubing to wooden surfaces. Ideal for neatly routing and attaching flexible plastic tubing to floor joists and wall studs. For CTS 1/2", 3/4" and 1". Sold in Bags of 100.						
	800-373	1/2"	Tube Talon		14.00	100	-
	800-374	3/4"	Tube Talon		18.00	100	-
	800-375	1"	Tube Talon		27.00	100	-

Tube Isolation Clamps	Part No.	Size	Configuration	Model No.	List Price	Qty.	Case
	Plastic tube fastener for isolating flexible plastic tube as it passes through building floor joists and wall studs. Protects tubing from sharp or hard surfaces, ideal for plumbing and hydronic piping. Includes two pre-drilled screw holes, fits CTS 1/2", 3/4" and 1". Sold in Bags of 100.						
	800-513	1/2"	Tube Isolation Clamp		18.00	100	-
	800-514	3/4"	Tube Isolation Clamp		20.00	100	-
	800-515	1"	Tube Isolation Clamp		32.00	100	-

Standard Tube Clamps	Part No.	Size	Configuration	Model No.	List Price	Qty.	Case
	Plastic tube fastener for securing flexible plastic tube to solid surfaces, floor joists and wall studs. Protects and keeps tubing straight when routing in plumbing and hydronic piping. Includes two pre-drilled screw holes, fits CTS 1/2", 3/4" and 1". Sold in Bags of 100.						
	800-523	1/2"	Standard Tube Clamp		18.00	100	-
	800-524	3/4"	Standard Tube Clamp		20.00	100	-
	800-525	1"	Standard Tube Clamp		27.00	100	-

Did you know? The Legend technical staff has extensive academic and practical plumbing and heating expertise.

TUBING INSTALLATION ACCESSORIES

Clip Tube Holders



SnappRAIL™ Clip Holders can be attached to the surface individually with a screw or nail (not included); or attach several in a row to clip holder rail (800-500) with adapter (800-501). Clip holders can quickly and easily secure either flexible tubing (PEX or PERT) or rigid copper tubing by pushing the tube into the mounted clip holder rail. Removal of the tubing, if necessary, is easy without damage to either the tubing or the clip holder.

SnappRAIL™ Clip Holders attach to clip holder rail with adapter (800-501). May also be fastened to joist or stud individually without rail.

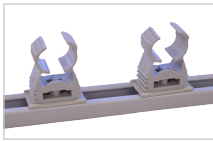

Part No.	Size	Configuration	Model No.	List Price	Qty.	Case
800-352	3/8"	Clip Tube Holder		1.09	100	-
800-353	1/2"	Clip Tube Holder		1.09	100	-
800-351	5/8"	Clip Tube Holder		1.21	100	-
800-354	3/4"	Clip Tube Holder		1.52	60	-
800-355	1"	Clip Tube Holder		1.93	50	-
800-356	1-1/4"	Clip Tube Holder		3.39	50	-

Clip Holder Rail

SnappRAIL™ Clip Holder Rail.



800-500	(39.37")	Clip Holder Rail		17.00	1	-
---------	----------	------------------	--	-------	---	---

Clip Holder Adapter

SnappRAIL™ Clip Holder Rail Adapter, holds clip tube holders.



800-501		Clip Holder Rail Adapter		2.30	20	-
---------	--	--------------------------	--	------	----	---

ST-100 Upright Staple Tool

Tube Installation Staple Tool - Upright hand staple tool for installing different sizes of tubing into EPS foam board. Long handle allows installer to easily staple down flexible radiant tube to rigid foam insulation while walking upright.



800-340	Upright hand staple tool		ST-100	819.45	1	1
800-340-34	1-3/8" long staple, 30 per magazine	For 1/2" tube, minimum 1/2" thick board	ST-100	8.20	30	-
800-340-40	1-1/2" long staple, 25 per magazine	For 5/8" tube, minimum 1" thick board	ST-100	5.84	25	-
800-340-55	2-1/8" long staple, 30 per magazine	For 3/4" tube, minimum 2" thick board	ST-100	8.48	30	-

LEGENDFlex™

Highly flexible PEX heating tube with oxygen barrier.

Manufactured from a proprietary polymer formulation which dramatically increases flexibility and maintains high strength. Available in 3/8", 1/2", 5/8", 3/4" and 1" tube sizes. LegendFlex™ delivers greater performance and flexibility than standard PEX. We are so confident in its performance we back it with a 30 year warranty.

LegendFlex™ is extremely flexible and very difficult to kink. In the unlikely event one should occur, simply repair it with a heat gun. No need to cut and use a coupling or replace the tubing.

LegendFlex™ tubing is also compatible with cold expansion type fitting systems (compliant with standards ASTM F 2080 & ASTM F 1960). Its strength, durability and thermal memory enables proper seal with crimp or expansion style connections.

Residential, commercial and industrial applications include:

- Radiant heating and cooling
- Snow & ice melt
- GeoThermal
- Turf conditioning



The externally extruded EVOH oxygen barrier reduces oxygen molecule permeation into the water. Compliant with standard DIN4756 (< 0.1 grams/m²/day).

Meets the requirements of ASTM F 876 and F 877

Heating Tube	Part No.	Size		List Price	Qty.	Case
	850-125	3/8" x 500'	PEX tubing with oxygen barrier, 20 lbs. capacity 0.0051 gal./ft.	375.00	1	-
	850-129	3/8" x 1000'	PEX tubing with oxygen barrier, 40 lbs. capacity 0.0051 gal./ft.	750.00	1	-
	850-133	1/2" x 300'	PEX tubing with oxygen barrier, 15 lbs. capacity 0.0096 gal./ft.	240.00	1	-
	850-135	1/2" x 500'	PEX tubing with oxygen barrier, 25 lbs. capacity 0.0096 gal./ft.	400.00	1	-
	850-139	1/2" x 1000'	PEX tubing with oxygen barrier, 50 lbs. capacity 0.0096 gal./ft.	800.00	1	-
	850-144	5/8" x 400'	PEX tubing with oxygen barrier, 28 lbs. capacity 0.0138 gal./ft.	400.00	1	-
	850-149	5/8" x 1000'	PEX tubing with oxygen barrier, 70 lbs. capacity 0.0138 gal./ft.	1000.00	1	-

LEGENDFLEX™ TUBING

Heating Tube (cont.)	Part No.	Size		List Price	Qty.	Case
	850-151	3/4" x 100'	PEX tubing with oxygen barrier, 10 lbs. capacity 0.0189 gal./ft.	131.84	1	-
	850-155	3/4" x 500'	PEX tubing with oxygen barrier, 50 lbs. capacity 0.0189 gal./ft.	659.20	1	-
	850-159	3/4" x 1000'	PEX tubing with oxygen barrier, 100 lbs. capacity 0.0189 gal./ft.	1280.00	1	-
	850-161	1" x 100'	PEX tubing with oxygen barrier, 16 lbs. capacity 0.0312 gal./ft.	253.00	1	-
	850-165	1" x 500'	PEX tubing with oxygen barrier, 80lbs. capacity 0.0312 gal./ft.	1265.00	1	-

Did you know? HyperPure™ bimodal PE-RT tubing is manufactured by Legend in Michigan. (See page 151)

You expect quality, we deliver it.

M-8000 MODULAR™

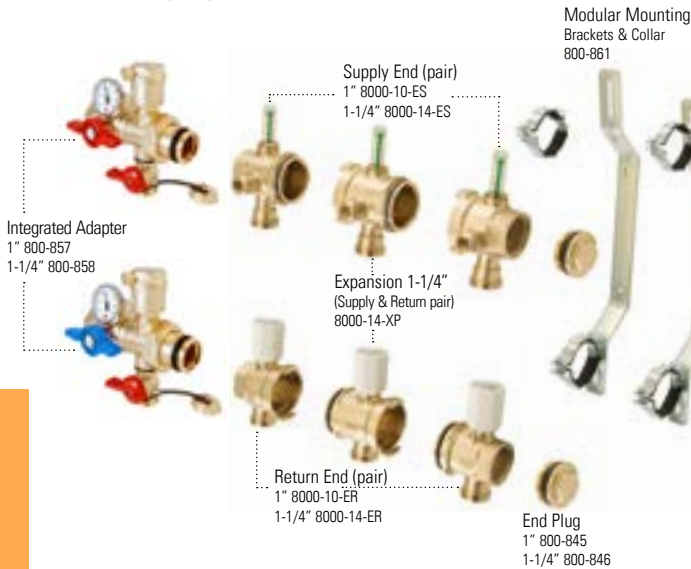

Carry less inventory and build any configuration you need!

The M-8000 Modular™ manifold series guarantees you'll always have the manifold you need when you need it. Precision-designed individual components can be easily customized to any solution a project requires. EPDM O-rings and CNC machining ensure a perfect seal, guaranteed. The M-8000 system makes on-site customization, configuration and installation a snap. By stocking a handful of interchangeable components, any manifold from 1" to 1-1/4", from 2 to 14 ports, with or without fill/purge valves can be built in minutes. Our modular system allows you to carry less inventory, yet stock exactly what you need to get the job done, especially when requirements change on the job site. Many components are compatible with our M-8100, M-8200 and M-8220 manifolds – making the Legend manifold family the most flexible manifold system on the market.

Key Features at a Glance

- Perfect seal - guaranteed
- Easy to assemble - twist & turn
- Flexible circuit orientation - service loops above and below manifold
- 2 GPM flow meters

Balancing valves with memory stop. Optional angle isolation valves for tight installations. Can be mounted in any orientation. Available in 1" and 1-1/4" configurations

M-8000™ MODULAR MANIFOLD SERIES KIT

M-8000 Kit	Part No.	Kit	List Price	Qty.
ISO 9002		M-8000 Modular Basic – Includes all required pieces to create basic 2-port 1" modular manifold.		
	8000-10-2	1" M-8000 Kit	303.36	
	8000-10-ES	1" Supply End- Pair		1
	8000-10-ER	1" Return End - Pair		1
	800-845	1" Manifold End Plug		2
	800-855	1" Manifold Isolation Valve - Pair		1
	800-861	Modular Manifold Mounting Bracket & Collar - Pair		1
		<i>Order expansion pairs as needed, page 107</i>		

M-8000A Kit	Part No.	Kit	List Price	Qty.
ISO 9002		M-8000A Modular Angle – Includes all required pieces to create basic 2-port 1" modular manifold with angle isolation valve		
	8000A-10-2	1" M-8000A Kit	360.68	
	8000-10-ES	1" Supply End - Pair		1
	8000-10-ER	1" Return End - Pair		1
	800-845	1" Manifold End Plug		2
	800-825	1" Manifold Angle Isolation Valve - Pair		1
	800-861	Modular Manifold Mounting Bracket & Collar - Pair		1
		<i>Order expansion pairs as needed, page 107</i>		

MANIFOLDS

M-8000™ MODULAR MANIFOLD SERIES KIT

M-8000S Kit

ISO 9002



M-8000S Modular Press – Includes all required pieces to create basic 2-port 1" modular manifold with LegendPress™ isolation valve.

Part No.	Kit	List Price	Qty.
8000S-10-2	1" M-8000S Kit	331.88	
8000-10-ES	1" Supply End - Pair		1
8000-10-ER	1" Return End - Pair		1
800-845	1" Manifold End Plug		2
800-865	1" LegendPress™ Manifold Isolation Valve - Pair		1
800-861	Modular Manifold Mounting Bracket & Collar - Pair		1

Order expansion pairs as needed, page 107

M-8000T Kit

ISO 9002



M-8000T Modular-T – Includes all required pieces to create basic 2-port 1" modular manifold with thermometer.

8000T-10-2	1" M-8000T Kit	360.68	
8000-10-ES	1" Supply End - Pair		1
8000-10-ER	1" Return End - Pair		1
800-845	1" Manifold End Plug		2
800-855T	1" Manifold Isolation Valve with Thermometer - Pair		1
800-861	Modular Manifold Mounting Bracket & Collar - Pair		1

Order expansion pairs as needed, page 107

M-8000P Kit

ISO 9002



M-8000P Modular Pro – Includes all required pieces to create basic 2-port 1" modular manifold with integrated adapter valve.

8000P-10-2	1" M-8000P Kit	466.68	
8000-10-ES	1" Supply End - Pair		1
8000-10-ER	1" Return End - Pair		1
800-845	1" Manifold End Plug		2
800-857	1" Integrated Manifold Adapter Valve - Pair		1
800-861	Modular Manifold Mounting Bracket & Collar - Pair		1

Order expansion pairs as needed, page 107

M-8000™ MODULAR MANIFOLD SERIES KIT

M-8000AP Kit

ISO 9002



M-8000AP Modular Angle-Pro – Includes all required pieces to create basic 2-port 1" modular manifold with precision adapter.

Part No.	Kit	List Price	Qty.
8000AP-10-2	1" M-8000P Kit	459.90	
8000-10-ES	1" Supply End - Pair		1
8000-10-ER	1" Return End - Pair		1
800-845	1" Manifold End Plug		2
800-855	1" Manifold Isolation Valve - Pair		1
800-805	1" Precision Adapter		1
800-861	Modular Manifold Mounting Bracket & Collar - Pair		1

Order expansion pairs as needed, page 107

M-8000SP Kit

ISO 9002



M-8000SP Modular Press-Pro – Includes all required pieces to create basic 2-port 1" modular manifold with LegendPress™ isolation valve.

8000SP-10-2	1" M-8000SP Kit	488.42	
8000-10-ES	1" Supply End - Pair		1
8000-10-ER	1" Return End - Pair		1
800-845	1" Manifold End Plug		2
800-865	1" LegendPress™ Manifold Isolation Valve - Pair		1
800-805	1" Precision Adapter		1
800-861	Modular Manifold Mounting Bracket & Collar - Pair		1

Order expansion pairs as needed, page 107

1-1/4" M-8000P Kit

ISO 9002



M-8000P 1-1/4" Modular Pro – Includes all required pieces to create basic 2-port 1-1/4" modular manifold with thermometer.

8000P-14-2	1-1/4" M-8000P Kit	545.24	
8000-14-ES	1-1/4" Supply End - Pair		1
8000-14-ER	1-1/4" Return End - Pair		1
800-846	1-1/4" Manifold End Plug		2
800-858	1-1/4" Integrated Adapter		1
800-861	Modular Manifold Mounting Bracket & Collar - Pair		1

Order expansion pairs as needed, page 107

M-8000 MODULAR™ COMPONENTS

Supply & Return Expansion Pair

ISO 9002



Part No.	List Price	Qty.
----------	------------	------

Supply and Return Expansion Pair – Order expansion quantities as required for headers with more than 2 circuits.

8000-14-XP	Supply and Return Expansion Pair	66.86	1
8000-14-MR	1-1/4" Modular Return Expansion	33.43	1
8000-14-MS	1-1/4" Modular Supply Expansion	33.43	1

Supply and Return Ends (M-8000 Components)



8000-10-ES	1" Modular Supply End - Matching Pair	66.85	1
8000-14-ES	1-1/4" Modular Supply End - Matching Pair	71.10	1
8000-10-ER	1" Modular Return End - Matching Pair	66.85	1
8000-14-ER	1-1/4" Modular Return End - Matching Pair	71.10	1

Note: End sections ship in matching right and left pairs. Request both supply & return end pairs when completing a modular manifold. Order expansion quantities as required for headers with more than 2 circuits.

End Plug with Gasket

ISO 9002



Brass Manifold End Plug – To close and seal manifold end.

800-845	1" Manifold End Plug	6.49	1
800-846	1-1/4" Manifold End Plug	9.02	1

Isolation Valve

ISO 9002



800-855	1" Manifold Isolation Valve - Matching Pair	116.68	1
800-855B	1" Manifold Isolation Valve - Blue Handle	58.34	1
800-855R	1" Manifold Isolation Valve - Red Handle	58.34	1
800-856	1-1/4" Manifold Isolation Valve - Matching Pair	164.88	1
800-856B	1-1/4" Manifold Isolation Valve - Blue Handle	82.44	1
800-856R	1-1/4" Manifold Isolation Valve - Red Handle	82.44	1

Note: Also used as loop isolation valve on M-8220 High Capacity™ and GeoGreen™ series manifolds.

Isolation Valve Thermometer

ISO 9002



Isolation Valves with Thermometer – For M-8000, M-8100 and M-8200 manifolds. Sold as red and blue handled pairs.

800-855T	1" Manifold Isolation Valve with Thermometer - Pair	174.00	1
800-856T	1-1/4" Manifold Isolation Valve with Thermometer - Pair	216.30	1

Note: Also used as loop isolation valve on M-8220 High Capacity™ and GeoGreen™ series manifolds.

M-8000 MODULAR™ COMPONENTS

Angle Isolation Valve **Part No.** **List Price** **Qty.**

ISO 9002



Angle Isolation Valve – For M-8000, M-8100 and M-8200 manifolds. Used for low profile installations when supply & return piping feeds from the ceiling or floor. Includes offset adapter to properly align vertical piping.

800-825 1" Manifold Angle Isolation Valve - Pair 174.00 1

LegendPress™ Isolation Valve

ISO 9002



LegendPress™ Isolation Valve – LegendPress™ style isolation valves feature two EPDM O-rings and deep sockets to ensure a perfect seal with every press.

800-865 1" LegendPress™ Manifold Isolation Valve - Pair 145.20 1

800-866 1-1/4" LegendPress™ Manifold Isolation Valve - Pair 207.50 1

Integrated Adapter Valve

ISO 9002



Integrated Adapter Valve – Includes garden hose thread fill & purge, air vent, thermometer, isolation valve and sensor port, all in one unit. For M-8000, M-8100 and M-8200.

800-857 1" Integrated Manifold Adapter Valve - Pair 280.00 1

800-858 1-1/4" Integrated Manifold Adapter Valve - Pair 345.00 1

Precision Adapter

ISO 9002



Precision Adapter – Includes garden hose thread fill & purge, air vent and thermometer. For M-8000, M-8100 and M-8200.

800-805 1" Manifold Precision Adapter - Pair 156.54 1

800-806 1-1/4" Manifold Precision Adapter - Pair 171.42 1

Mounting Bracket

ISO 9002



Mounting Brackets for M-8000 Manifold.

800-861 Modular Manifold Mounting Bracket & Collar - Pair 40.00 1

M-8100

ENGINEERED PLASTIC



The “all-in-one” manifold - lightweight, yet durable. Pre-assembled, yet easily adaptable!

The M-8100 Engineered Plastic manifold provides many solutions in this superbly designed series. It is manufactured from a high-performance, lightweight polymer that is durable and strong. It can withstand pressures and temperatures well beyond what is needed for even the most demanding radiant heating or cooling project. The M-8100 manifold is shipped pre-assembled and mounted on brackets so it's ready to be installed out of the box. Plus, its circuit loop “add-on” capability allows for convenient adaptability to accommodate project changes. The variety of available kits, accessories and options provide for optimal flexibility.

Key Features at a Glance

- Manufactured from advanced polymer – strong and very durable yet lightweight
- Pre-assembled for easy installation
- Field expandable allowing easy adaptability to project changes
- Variety of connection options– threaded, LegendPress™, angle, built-in thermometers, compression and F 1960 cold expansion style
- Built-in loop isolation, balancing and flow meters (0 to 2 GPM) for easy set-up and optimization

M-8100 ENGINEERED PLASTIC MANIFOLD

M-8100P Engineered Plastic Pro	Part No.	List Price	Qty.
ISO 9002			
	M-8100P EP Pro Manifold – Includes integrated adapter valve with garden hose thread fill & purge valve, automatic air vent, thermometer, isolation valve and sensor port all in one unit.		
	8100P-10-2	2 Port – 1” EP Pro Manifold with Integrated Adapter Valve	350.00 1
	8100P-10-3	3 Port – 1” EP Pro Manifold with Integrated Adapter Valve	392.00 1
	8100P-10-4	4 Port – 1” EP Pro Manifold with Integrated Adapter Valve	448.00 1
	8100P-10-5	5 Port – 1” EP Pro Manifold with Integrated Adapter Valve	504.00 1
	8100P-10-6	6 Port – 1” EP Pro Manifold with Integrated Adapter Valve	561.00 1
	8100P-10-7	7 Port – 1” EP Pro Manifold with Integrated Adapter Valve	619.00 1
	8100P-10-8	8 Port – 1” EP Pro Manifold with Integrated Adapter Valve	681.00 1
	8100P-10-9	9 Port – 1” EP Pro Manifold with Integrated Adapter Valve	752.00 1
	8100P-10-10	10 Port – 1” EP Pro Manifold with Integrated Adapter Valve	769.00 1
	8100P-10-11	11 Port – 1” EP Pro Manifold with Integrated Adapter Valve	841.00 1
	8100P-10-12	12 Port – 1” EP Pro Manifold with Integrated Adapter Valve	911.00 1



M-8100 ENGINEERED PLASTIC MANIFOLD

M-8100A Engineered Plastic Angle **Part No.** **List Price** **Qty.**

ISO 9002

M-8100A EP Angle – Includes angle isolation valves with offset adapter for vertical piping applications, and ships loosely pre-assembled ready to install.



8100A-10-2	2 Port – 1" EP Angle Manifold with Angle Isolation Valve	280.00	1
8100A-10-3	3 Port – 1" EP Angle Manifold with Angle Isolation Valve	325.00	1
8100A-10-4	4 Port – 1" EP Angle Manifold with Angle Isolation Valve	372.00	1
8100A-10-5	5 Port – 1" EP Angle Manifold with Angle Isolation Valve	422.00	1
8100A-10-6	6 Port – 1" EP Angle Manifold with Angle Isolation Valve	480.00	1
8100A-10-7	7 Port – 1" EP Angle Manifold with Angle Isolation Valve	535.00	1
8100A-10-8	8 Port – 1" EP Angle Manifold with Angle Isolation Valve	589.00	1
8100A-10-9	9 Port – 1" EP Angle Manifold with Angle Isolation Valve	659.00	1
8100A-10-10	10 Port – 1" EP Angle Manifold with Angle Isolation Valve	735.00	1
8100A-10-11	11 Port – 1" EP Angle Manifold with Angle Isolation Valve	802.00	1
8100A-10-12	12 Port – 1" EP Angle Manifold with Angle Isolation Valve	870.00	1

M-8100 Engineered Plastic Basic

ISO 9002

M-8100 EP Basic Manifold – Includes threaded (FNPT) isolation valves and ships loosely pre-assembled ready to install.



8100-10-2	2 Port – 1" EP Basic Manifold with Isolation Valve	245.00	1
8100-10-3	3 Port – 1" EP Basic Manifold with Isolation Valve	295.00	1
8100-10-4	4 Port – 1" EP Basic Manifold with Isolation Valve	344.00	1
8100-10-5	5 Port – 1" EP Basic Manifold with Isolation Valve	390.00	1
8100-10-6	6 Port – 1" EP Basic Manifold with Isolation Valve	444.00	1
8100-10-7	7 Port – 1" EP Basic Manifold with Isolation Valve	495.00	1
8100-10-8	8 Port – 1" EP Basic Manifold with Isolation Valve	545.00	1
8100-10-9	9 Port – 1" EP Basic Manifold with Isolation Valve	610.00	1
8100-10-10	10 Port – 1" EP Basic Manifold with Isolation Valve	680.00	1
8100-10-11	11 Port – 1" EP Basic Manifold with Isolation Valve	742.00	1
8100-10-12	12 Port – 1" EP Basic Manifold with Isolation Valve	805.00	1

M-8100 ENGINEERED PLASTIC MANIFOLD COMPONENTS

Header Isolation Valve Connector





ISO 9002

EP Header Isolation Valve Connector – For both supply and return to allow connection of header isolation valves. Includes large header c-clip, double o-ring and spacer ring.



810-105	EP Header Isolation Valve Connector – Pair	40.00	1
---------	--	-------	---

M-8100 ENGINEERED PLASTIC MANIFOLD COMPONENTS

End Plug	Part No.	List Price	Qty.
<p>ISO 9002</p> 	<p>EP End Plug – For both supply & return, to close and seal manifold headers. Includes large header c-clip, double o-ring and spacer ring.</p> <p>810-102 EP End Plug – Pair</p>	<p>35.00</p>	<p>1</p>
<p>Expansion Supply & Return</p> <p>ISO 9002</p> 	<p>EP Expansion – Includes one each for both supply and return. Add as necessary to end plug and header isolation valve connector to provide circuit loops to the manifold assembly. Includes large c-clip, double o-ring and spacer ring.</p> <p>8100-10-XP EP Expansion - Pair</p>	<p>75.00</p>	<p>1</p>
<p>Manifold Mounting Bracket</p> <p>ISO 9002</p> 	<p>Manifold Mounting Brackets & Collar – For M-8100 manifolds, adjustable height/distance between headers.</p> <p>810-100 EP Manifold Mounting Bracket & Collar - Pair</p>	<p>35.00</p>	<p>1</p>
<p>PTFE Header Connector</p> <p>ISO 9002</p> 	<p>EP PTFE Header Connector – Allows connection of brass isolation valves to manifold headers, both supply and return. Required for isolation valves with or without thermometers, angle and LegendPress™ configurations.</p> <p>810-106 EP PTFE Header Connector – Pair</p>	<p>30.28</p>	<p>1</p>
<p>Brass Bushing</p> <p>ISO 9002</p> 	<p>EP Brass Bushing – Allows connection of brass angle isolation valve offset adapter and precision adapter to manifold headers, as needed.</p> <p>810-107 EP Brass Bushing - Each</p>	<p>8.34</p>	<p>1</p>

MANIFOLDS

M-8100 ENGINEERED PLASTIC MANIFOLD COMPONENTS

Large Header C-Clip **Part No.** **List Price** **Qty.**

ISO 9002



EP Large Header C-Clip— Replacement c-clips for securing header isolation valve connectors, end plugs and expansion pieces together. Sold in bags of 10.

810-103 EP Large Header C-Clip - Pair 45.00 10

Tube Connector C-Clip

ISO 9002



EP Tube Connector C-Clip — Replacement c-clips for securing brass port connections to manifold headers, both supply and return. Sold in bags of 10.

810-104 EP Tube Connector C-Clip - Pair 20.00 10

PEX Connectors

ISO 9002



3/4" connector

PEX Tube Connectors - For M-8100EP manifold only.

810-142EP	3/8" PEX to EP Manifold Connector - Pair	28.00	1
810-143EP	1/2" PEX to EP Manifold Connector - Pair	20.00	1
810-144EP	5/8" PEX to EP Manifold Connector - Pair	21.00	1
810-145EP	3/4" PEX to EP Manifold Connector - Pair	45.00	1

Not for use with PEX-AL-PEX tube

Did you know? Legend University hydronic contractor training is scheduled throughout the year.

M-8200 PRECISION™



The M-8200 Precision™ manifold is fully loaded with the features and benefits required for high performance. Flow metering and balancing are built-in, and there is unlimited flexibility in positioning the manifold in any direction. The unique “integrated adapter” combines isolation, temperature, air vent and fill & purge valves into one compact unit. Only Legend places the air vent in-line with the water flow removing more air than typical end mount installations. Many components are compatible with our M-8000, M-8100 and M-8220 manifolds – making the Legend manifold series the most flexible manifold system on the market.

Key Features at a Glance

- 2 GPM flow meters
- Balancing valves with memory stop
- Optional 4-wire actuators
- Manifold union available for easy circuit expansion
- Optional LegendPress™ and angle isolation valves available
- Optional compact “integrated adapter” removes more air

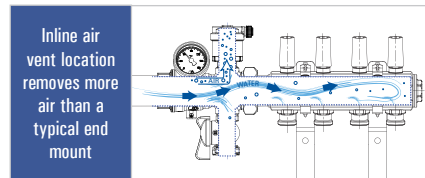

M-8200 PRECISION™ MANIFOLD

M-8200P Precision™ Pro

ISO 9002

Part No.

List Price

Qty.

M-8200P Precision-Pro Manifold – Includes integrated adapter valve with garden hose thread fill & purge valve, automatic air vent, thermometer, isolation valve and sensor port all in one unit.



8200P-10-2	2 Port	1" Brass Bar	460.00	1
8200P-10-3	3 Port	1" Brass Bar	546.00	1
8200P-10-4	4 Port	1" Brass Bar	622.00	1
8200P-10-5	5 Port	1" Brass Bar	673.00	1
8200P-10-6	6 Port	1" Brass Bar	745.00	1
8200P-10-7	7 Port	1" Brass Bar	821.00	1
8200P-10-8	8 Port	1" Brass Bar	888.00	1
8200P-10-9	9 Port	1" Brass Bar	966.00	1
8200P-10-10	10 Port	1" Brass Bar	1069.00	1
8200P-10-11	11 Port	1" Brass Bar	1130.00	1
8200P-10-12	12 Port	1" Brass Bar	1205.00	1
8200P-14-4	4 Port	1-1/4" Brass Bar	710.00	1
8200P-14-5	5 Port	1-1/4" Brass Bar	791.00	1
8200P-14-6	6 Port	1-1/4" Brass Bar	869.00	1
8200P-14-7	7 Port	1-1/4" Brass Bar	952.00	1
8200P-14-8	8 Port	1-1/4" Brass Bar	1032.00	1
8200P-14-9	9 Port	1-1/4" Brass Bar	1109.00	1
8200P-14-10	10 Port	1-1/4" Brass Bar	1216.00	1
8200P-14-11	11 Port	1-1/4" Brass Bar	1303.00	1
8200P-14-12	12 Port	1-1/4" Brass Bar	1394.00	1

M-8200 PRECISION™ MANIFOLD

M-8200AP Precision™ Angle Pro

ISO 9002



Part No. **List Price** **Qty.**

M-8200AP Precision Manifold with Angle Isolation Valve – Angle connection and isolation valve in one body allows connection of supply and distribution piping from above or below in a tight configuration.

8200AP-10-2	2 Port	1" Brass Bar	520.00	1
8200AP-10-3	3 Port	1" Brass Bar	606.00	1
8200AP-10-4	4 Port	1" Brass Bar	671.00	1
8200AP-10-5	5 Port	1" Brass Bar	733.00	1
8200AP-10-6	6 Port	1" Brass Bar	806.00	1
8200AP-10-7	7 Port	1" Brass Bar	881.00	1
8200AP-10-8	8 Port	1" Brass Bar	948.00	1
8200AP-10-9	9 Port	1" Brass Bar	1026.00	1
8200AP-10-10	10 Port	1" Brass Bar	1120.00	1
8200AP-10-11	11 Port	1" Brass Bar	1180.00	1
8200AP-10-12	12 Port	1" Brass Bar	1266.00	1

M-8200SP Precision™ Press Pro

ISO 9002



M-8200SP Precision Manifold with LegendPress™ – Press style isolation valves featuring two EPDM O-rings and deep sockets to ensure a perfect seal without the need for either solder or thread sealant.

8200SP-10-2	2 Port	1" Brass Bar	490.00	1
8200SP-10-3	3 Port	1" Brass Bar	576.00	1
8200SP-10-4	4 Port	1" Brass Bar	640.00	1
8200SP-10-5	5 Port	1" Brass Bar	703.00	1
8200SP-10-6	6 Port	1" Brass Bar	775.00	1
8200SP-10-7	7 Port	1" Brass Bar	851.00	1
8200SP-10-8	8 Port	1" Brass Bar	918.00	1
8200SP-10-9	9 Port	1" Brass Bar	996.00	1
8200SP-10-10	10 Port	1" Brass Bar	1079.00	1
8200SP-10-11	11 Port	1" Brass Bar	1139.00	1
8200SP-10-12	12 Port	1" Brass Bar	1212.00	1
8200SP-14-4	4 Port	1-1/4" Brass Bar	734.00	1
8200SP-14-5	5 Port	1-1/4" Brass Bar	813.00	1
8200SP-14-6	6 Port	1-1/4" Brass Bar	889.00	1
8200SP-14-7	7 Port	1-1/4" Brass Bar	969.00	1
8200SP-14-8	8 Port	1-1/4" Brass Bar	1047.00	1
8200SP-14-9	9 Port	1-1/4" Brass Bar	1122.00	1
8200SP-14-10	10 Port	1-1/4" Brass Bar	1204.00	1
8200SP-14-11	11 Port	1-1/4" Brass Bar	1286.00	1
8200SP-14-12	12 Port	1-1/4" Brass Bar	1372.00	1

M-8200 PRECISION™ MANIFOLD

M-8200T Precision™ Thermometer

ISO 9002



M-8200T Precision Manifold with Thermometer – Includes isolation valves with thermometer for supply and return temperature measurement. Ships loosely assembled and ready to install.

Part No.			List Price	Qty.
8200T-10-2	2 Port	1" Brass Bar	369.00	1
8200T-10-3	3 Port	1" Brass Bar	448.00	1
8200T-10-4	4 Port	1" Brass Bar	505.00	1
8200T-10-5	5 Port	1" Brass Bar	573.00	1
8200T-10-6	6 Port	1" Brass Bar	638.00	1
8200T-10-7	7 Port	1" Brass Bar	719.00	1
8200T-10-8	8 Port	1" Brass Bar	791.00	1
8200T-10-9	9 Port	1" Brass Bar	866.00	1
8200T-10-10	10 Port	1" Brass Bar	977.00	1
8200T-10-11	11 Port	1" Brass Bar	1042.00	1
8200T-10-12	12 Port	1" Brass Bar	1125.00	1
8200T-14-4	4 Port	1-1/4" Brass Bar	613.00	1
8200T-14-5	5 Port	1-1/4" Brass Bar	685.00	1
8200T-14-6	6 Port	1-1/4" Brass Bar	748.00	1
8200T-14-7	7 Port	1-1/4" Brass Bar	835.00	1
8200T-14-8	8 Port	1-1/4" Brass Bar	910.00	1
8200T-14-9	9 Port	1-1/4" Brass Bar	991.00	1
8200T-14-10	10 Port	1-1/4" Brass Bar	1079.00	1
8200T-14-11	11 Port	1-1/4" Brass Bar	1168.00	1
8200T-14-12	12 Port	1-1/4" Brass Bar	1261.00	1

M-8200 Precision™ Basic

ISO 9002



M-8200 Precision Basic Manifold – Ships loosely assembled and ready to install.

8200-10-2	2 Port	1" Brass Bar	320.00	1
8200-10-3	3 Port	1" Brass Bar	397.00	1
8200-10-4	4 Port	1" Brass Bar	462.00	1
8200-10-5	5 Port	1" Brass Bar	524.00	1
8200-10-6	6 Port	1" Brass Bar	597.00	1
8200-10-7	7 Port	1" Brass Bar	672.00	1
8200-10-8	8 Port	1" Brass Bar	739.00	1
8200-10-9	9 Port	1" Brass Bar	809.00	1
8200-10-10	10 Port	1" Brass Bar	910.00	1
8200-10-11	11 Port	1" Brass Bar	980.00	1
8200-10-12	12 Port	1" Brass Bar	1051.00	1

M-8200 PRECISION™ MANIFOLD

M-8200 Precision™ Basic (cont.)	Part No.			List Price	Qty.
ISO 9002					
	8200-14-4	4 Port	1-1/4" Brass Bar	547.00	1
	8200-14-5	5 Port	1-1/4" Brass Bar	629.00	1
	8200-14-6	6 Port	1-1/4" Brass Bar	706.00	1
	8200-14-7	7 Port	1-1/4" Brass Bar	797.00	1
	8200-14-8	8 Port	1-1/4" Brass Bar	870.00	1
	8200-14-9	9 Port	1-1/4" Brass Bar	947.00	1
	8200-14-10	10 Port	1-1/4" Brass Bar	1051.00	1
	8200-14-11	11 Port	1-1/4" Brass Bar	1137.00	1
	8200-14-12	12 Port	1-1/4" Brass Bar	1228.00	1

M-8200 PRECISION™ ACCESSORIES

Integrated Adapter Valve

ISO 9002 **Integrated Adapter Valves** – Includes garden hose thread fill & purge, air vent, thermometer, isolation valve and sensor port, all in one unit. For M-8000, M-8100 and M-8200.



800-857	1" Integrated Manifold Adapter Valve – Pair	280.00	1
800-858	1-1/4" Integrated Manifold Adapter Valve – Pair	345.00	1
800-853	Replacement Thermometer	37.94	1

Precision Adapter

ISO 9002 **Precision Adapters** – Includes garden hose thread fill & purge, air vent and press. For M-8000, M-8100 and M-8200.



800-805	1" Manifold Precision Adapter – Pair	156.54	1
800-806	1-1/4" Manifold Precision Adapter – Pair	171.42	1
800-803	Replacement Thermometer with Thermowell	37.94	1

Air Vent

ISO 9002 **Automatic Air Vent** – Replacement air vent for precision adapter and integrated adapter valve.



800-332	Automatic Air Vent	14.09	1
---------	--------------------	-------	---

Fill & Purge Valve

ISO 9002 **Replacement Fill & Purge Valve** – Replacement fill & purge valve for precision adapter and integrated adapter valve. Quarter-turn ball valve with tethered cap, garden hose thread (GHT) connection and EPDM gasket/O-ring seals.



800-802	Replacement Fill & Purge Valve	24.00	1
---------	--------------------------------	-------	---

M-8200 PRECISION™ ACCESSORIES

Isolation Valve	Part No.	List Price	Qty.
-----------------	----------	------------	------

ISO 9002



Isolation Valves - For M-8000, M-8100, and M-8200 manifolds.

800-855	1" Manifold Isolation Valve - Matching Pair	116.68	1
800-855B	1" Manifold Isolation Valve - Blue Handle	58.34	1
800-855R	1" Manifold Isolation Valve - Red Handle	58.34	1
800-856	1-1/4" Manifold Isolation Valve - Matching Pair	164.88	1
800-856B	1-1/4" Manifold Isolation Valve - Blue Handle	82.44	1
800-856R	1-1/4" Manifold Isolation Valve - Red Handle	82.44	1

Note: Also used as loop isolation valve on M-8220 High Capacity™ and GeoGreen™ series manifolds.

Isolation Valve

ISO 9002



Isolation Valves with Thermometer – For M-8000, M-8100 and M-8200 manifolds. Converts the **M-8200** to the **M-8200T**.

800-855T	1" Manifold Isolation Valve with Thermometer - Pair	174.00	1
800-856T	1-1/4" Manifold Isolation Valve with Thermometer - Pair	216.30	1

Note: Also used as loop isolation valve on M-8220 High Capacity™ and GeoGreen™ series manifolds.

Angle Isolation Valve

ISO 9002



Angle Isolation Valves – For M-8000, M-8100 and M-8200 manifolds. Used for low profile installations when supply & return piping feeds from the ceiling or floor. Includes offset adapter to properly align vertical piping.

800-825	1" Manifold Angle Isolation Valve - Pair	174.00	1
---------	--	--------	---

LegendPress™ Isolation Valve

ISO 9002



LegendPress™ Isolation Valves – For M-8000, M-8100 and M-8200 manifolds. Press style isolation valves feature two EPDM O-rings and deep sockets to ensure a perfect seal with every press.

800-865	1" LegendPress™ Manifold Isolation Valve - Pair	145.20	1
800-866	1-1/4" LegendPress™ Manifold Isolation Valve - Pair	207.50	1

Mounting Bracket

ISO 9002



Mounting Brackets – For M-8000 and M-8200 Manifolds.

800-861	M-8000 Modular - Manifold Mounting Bracket & Collar - Pair	40.00	1
800-860	M-8200 Precision - Manifold Mounting Bracket & Collar - Pair	30.53	1

M-8200 PRECISION™ ACCESSORIES

Circuit Actuator **Part No.** **List Price** **Qty.**

ISO 9002



4-Wire Circuit Actuator – For M-8000, M-8100 and M-8200 series manifolds. 24 volt AC actuator with 36" leads. Includes end switch that closes when valve is fully open.

800-200	4-Wire Circuit Actuator with End Switch	77.02	1
---------	---	-------	---

Manifold Union

ISO 9002



Manifold Union – Connects any two M-8200 series manifolds to increase circuit capacity.

800-815	1" Manifold Union	10.82	1
800-816	1-1/4" Manifold Union	17.14	1

End Plug with Gasket

ISO 9002



Brass Manifold End Plug – With EPDM O-ring. Used on all M-8000 and M-8200 series manifolds to close and seal manifold end.

800-845	1" Manifold End Plug	6.49	1
800-846	1-1/4" Manifold End Plug	9.02	1

Port Cap

ISO 9002



Manifold Port Cap – Used to close and seal unused ports on M-8000, M-8100 and M-8200 manifolds. Includes EPDM O-ring.

800-141	Manifold Port Cap	3.10	1
---------	-------------------	------	---

PEX Tube Connector

ISO 9002



3/4" connector

PEX Tube Connectors – For M-8000 and M-8200 series manifolds. (Not for use with PEX-AL-PEX tube).

800-140	5/16" PEX to Manifold Connector - Pair	19.16	1
800-142	3/8" PEX to Manifold Connector - Pair	15.77	1
800-143	1/2" PEX to Manifold Connector - Pair	15.98	1
800-144	5/8" PEX to Manifold Connector - Pair	15.98	1
800-145	3/4" PEX to Manifold Connector - Pair	25.47	1

MANIFOLDS

M-8200 PRECISION™ ACCESSORIES

Composite Tube Connector	Part No.	List Price	Qty.
<p>ISO 9002</p>  <p>3/4" connector</p>	<p>Composite Tube Connectors – For all M-8000 and M-8200 series manifolds. (For use with PEX-AL-PEX tube.)</p> <p>800-143C 1/2" Composite Tube to Manifold Connector - Pair</p> <p>800-144C 5/8" Composite Tube to Manifold Connector - Pair</p> <p>800-145C 3/4" Composite Tube to Manifold Connector - Pair</p>	<p>16.80</p> <p>18.69</p> <p>47.36</p>	<p>1</p> <p>1</p> <p>1</p>

Cold Expansion PEX Tube Connector

<p>ISO 9002, ASTM F 1960</p> 	<p>Cold Expansion PEX Tube Connectors – For all M-8000 and M-8200 series manifolds. Installer must verify with tube manufacturer that the tubing is compatible with expansion type fitting systems.</p> <p>800-143P 1/2" Expansion PEX to Manifold Connector - Pair</p> <p>800-144P 5/8" Expansion PEX to Manifold Connector - Pair</p> <p>800-145P 3/4" Expansion PEX to Manifold Connector - Pair</p>	<p>26.20</p> <p>30.50</p> <p>42.00</p>	<p>1</p> <p>1</p> <p>1</p>
--	---	--	----------------------------

MANIFOLDS

Did you know? Legend has a multi-room training house for contractor and wholesaler hydronic classes.

M-8220

HIGH CAPACITY™



Thermal insulation jackets available, Items 822-867 & 822-868

The M-8220 high capacity manifold is ideal for hydronic radiant applications that require high flow rates such as snow & ice melt systems or projects with large floor areas (warehouses, commercial garages, airplane hangers, manufacturing facilities, etc). This versatile manifold can also be used in the mechanical room for flow distribution in hydronic systems where each branch is supplying one or more zones of radiant panel manifolds, radiator panels, baseboard, fan coil units, etc. The M-8220 provides full isolation at each header and circuit loop with color coded handles. The header valves are available with standard pipe thread or press style connections. Depending upon circuit balancing requirements, FNPT and Press circuit isolation valves are available. Many components are compatible with our M-8000, M-8100 and M-8200 manifolds – making the Legend manifold series the most flexible manifold system on the market.

Key Features at a Glance

- Extruded from high-strength OT63 alloy-63% copper content
- Header isolation valves with threaded or LegendPress™ connections
- High flow capacity
- Manifold unions available to expand number of circuit loops
- Includes strong and versatile mounting brackets
- Automatic air vent and GHT fill/purge assemblies included

MANIFOLDS

M-8220 HIGH CAPACITY MANIFOLD

M-8220	Part No.	List Price	Qty.
ISO 9002	M-8220 High Capacity Manifold Base Kit – Base includes supply and return headers, 1-1/2" FNPT isolation valves for headers, 1" NPT circuit loop isolation valves for supply and return, mounting brackets, and fill & air purger.		
	8220-15-2	2 Port - 2 Brackets 1-1/2" Hi-Cap Base	1047.00 1
	8220-15-3	3 Port - 4 Brackets 1-1/2" Hi-Cap Base	1418.00 1
	8220-15-4	4 Port - 4 Brackets 1-1/2" Hi-Cap Base	1671.00 1
	8220-15-5	5 Port - 4 Brackets 1-1/2" Hi-Cap Base	1898.00 1
	8220-15-6	6 Port - 4 Brackets 1-1/2" Hi-Cap Base	2147.00 1
	8220-15-7	7 Port - 4 Brackets 1-1/2" Hi-Cap Base	2378.00 1
	8220-15-8	8 Port - 4 Brackets 1-1/2" Hi-Cap Base	2618.00 1
	8220-20-2	2 Port - 2 Brackets 2" Hi-Cap Base	1196.00 1
8220-20-3	3 Port - 4 Brackets 2" Hi-Cap Base	1593.00 1	
8220-20-4	4 Port - 4 Brackets 2" Hi-Cap Base	1856.00 1	
8220-20-5	5 Port - 4 Brackets 2" Hi-Cap Base	2123.00 1	
8220-20-6	6 Port - 4 Brackets 2" Hi-Cap Base	2385.00 1	

M-8220 HIGH CAPACITY MANIFOLD

M-8220P

ISO 9002



Part No.

List Price

Qty.

M-8220P High Capacity Manifold Press Kit – Base includes supply and return headers, 1-1/2" LegendPress™ isolation valves for headers, 1" NPT circuit loop isolation valves for supply and return, mounting brackets, and fill & air purger.

8220S-15-2	2 Port - 2 Brackets	1-1/2" Hi-Cap Base	1113.00	1
8220S-15-3	3 Port - 4 Brackets	1-1/2" Hi-Cap Base	1484.00	1
8220S-15-4	4 Port - 4 Brackets	1-1/2" Hi-Cap Base	1737.00	1
8220S-15-5	5 Port - 4 Brackets	1-1/2" Hi-Cap Base	1964.00	1
8220S-15-6	6 Port - 4 Brackets	1-1/2" Hi-Cap Base	2213.00	1
8220S-15-7	7 Port - 4 Brackets	1-1/2" Hi-Cap Base	2444.00	1
8220S-15-8	8 Port - 4 Brackets	1-1/2" Hi-Cap Base	2684.00	1
8220S-20-2	2 Port - 2 Brackets	2" Hi-Cap Base	1262.00	1
8220S-20-3	3 Port - 4 Brackets	2" Hi-Cap Base	1659.00	1
8220S-20-4	4 Port - 4 Brackets	2" Hi-Cap Base	1922.00	1
8220S-20-5	5 Port - 4 Brackets	2" Hi-Cap Base	2189.00	1
8220S-20-6	6 Port - 4 Brackets	2" Hi-Cap Base	2451.00	1

M-8220X

ISO 9002



M-8220X High Capacity Manifold Expansion Kit – Base includes supply and return headers, 1" NPT circuit loop isolation valves for supply & return, mounting brackets, and 2 manifold unions.

8220-15-2X	2 Port - 2 Brackets	1-1/2" Hi-Cap Expansion	722.00	1
8220-15-3X	3 Port - 4 Brackets	1-1/2" Hi-Cap Expansion	1093.00	1
8220-15-4X	4 Port - 4 Brackets	1-1/2" Hi-Cap Expansion	1346.00	1
8220-15-5X	5 Port - 4 Brackets	1-1/2" Hi-Cap Expansion	1573.00	1
8220-15-6X	6 Port - 4 Brackets	1-1/2" Hi-Cap Expansion	1822.00	1
8220-15-7X	7 Port - 4 Brackets	1-1/2" Hi-Cap Expansion	2053.00	1
8220-15-8X	8 Port - 4 Brackets	1-1/2" Hi-Cap Expansion	2293.00	1
8220-20-2X	2 Port - 2 Brackets	2" Hi-Cap Expansion	871.00	1
8220-20-3X	3 Port - 4 Brackets	2" Hi-Cap Expansion	1268.00	1
8220-20-4X	4 Port - 4 Brackets	2" Hi-Cap Expansion	1531.00	1
8220-20-5X	5 Port - 4 Brackets	2" Hi-Cap Expansion	1798.00	1
8220-20-6X	6 Port - 4 Brackets	2" Hi-Cap Expansion	2060.00	1



M-8220 Expansion Kit - Order expansion kits as required to build manifolds with more than 8 ports in 1-1/2" and 6 ports in 2" sizes. Expansion kit includes 2 manifold unions in place of the 2 fill & purge assemblies.

Substitute one or more multiple pairs of loop isolation valves with thermometer, in place of the standard loop isolation valves included with the manifold kits. The supply and return thermometer can provide means to determine delta T and help balance flow rates. Call customer service to make application adjustments (866) 752-2055.

M-8220 MANIFOLD ACCESSORIES

High Capacity Isolation Valve **Part No.** **List Price** **Qty.**

ISO 9002



High Capacity Header Isolation Valves – For M-8220 and GeoGreen™ M-8400 manifolds.

822-857 1-1/2" Manifold Header Isolation Valve - Pair 325.00 1

Note: 2" x 1-1/2" Manifold isolation valve adapter provided with 2" base kits.

LegendPress™ Isolation Valve

ISO 9002



High Capacity Header Isolation Valves with LegendPress™ Connection – For M-8220 and GeoGreen™ M-8400 manifolds. Legend's press connection isolation valves feature two EPDM O-rings and deep sockets to ensure a perfect seal with every press.

800-867 1-1/2" LegendPress™ Manifold Header Isolation Valve - Pair 398.48 1

Note: 2" x 1-1/2" Manifold isolation valve adapter provided with 2" base kits.

Loop Isolation Valve

ISO 9002



Loop Isolation Valves – For M-8220 and GeoGreen™ M-8400 manifolds.

800-855 1" Loop Isolation Valve - Pair 116.68 1

Note: May be used with 3/4" or 1" high capacity tubing connectors. Also used as header isolation valve on M-8000, M-8100 and M-8200 series manifolds.

Loop Isolation Valve Thermometer

ISO 9002



Loop Isolation Valves with Thermometer – For M-8220 and GeoGreen™ M-8400 manifolds. Two press ports (left or right) add flexibility in mounting.

800-855T 1" Loop Isolation Valve with Thermometer - Pair 174.00 1

Note: May be used with 3/4" or 1" high capacity tubing connectors. Also used as header isolation valve on M-8000, M-8100 and M-8200 series manifolds.

Manifold Union

ISO 9002



High Capacity Manifold Union – Connects any two M-8220 series manifolds to increase circuit capacity.

822-817 1-1/2" High Capacity Manifold Union - Pair 31.00 1

822-818 2" High Capacity Manifold Union - Pair 42.00 1

M-8220 MANIFOLD ACCESSORIES

Compression Tube Connector

ISO 9002



Part No.	List Price	Qty.	
High Capacity Compression Tube Connectors – For M-8220 manifolds. 1" male MPT x copper tube size.			
800-134	3/4" High Capacity Compression Connector - Pair	42.00	1
800-135	1" High Capacity Compression Connector - Pair	46.20	1

For use with copper tube.

PEX Connector

ISO 9002



High Capacity PEX Tube Connectors – For M-8220 and M-8400 GeoGreen™ M-8400 manifolds. 1" male NPT x PEX.

800-234	3/4" High Capacity PEX Connector - Pair	62.83	1
800-235	1" High Capacity PEX Connector - Pair	77.00	1

Mounting Bracket

ISO 9002



High Capacity Manifold Mounting Brackets – Replacement brackets and collars for M-8220 and GeoGreen™ M-8400 manifolds. Replacement collars for M-8220 with insulation jackets.

822-861	High Capacity Manifold Mounting Bracket & Collar - Pair	50.00	1
822-862	Large Collar for 1-1/2" Manifold with Insulation Jacket - Pair	38.00	1
822-863	Large Collar for 2" Manifold with Insulation Jacket - Pair	52.00	1

Note: Item 822-861 to be used for M-8200 & M-8400. Order large collars when using insulation jackets (822-867 and 822-868) are used on M-8220.

Insulation Jacket

ISO 9002



6 Port Insulation Jacket – For M-8220 series manifolds. Easily cut to size for manifolds with fewer loops.

822-867	1-1/2" High Capacity 6-Port Insulation Jacket - 1 header	39.00	1
822-868	2" High Capacity 6-Port Insulation Jacket - 1 header	42.00	1

Note: Order insulation jackets and large collars (822-862 for 1-1/2" manifolds & 822-863 for 2" manifolds) individually for each header.

High Capacity Air Vent

ISO 9002



High Capacity Air Vent – Replacement air vent for fill and purge module M-8220. Vent can be serviced by removing the cap, includes check valve.

800-244	High Capacity Air Vent	34.00	1
---------	------------------------	-------	---



M-8400 GeoGreen™ mounted ground vault

The Legend GeoGreen™ M-8400 Geothermal™ manifold system offers the ultimate in lightweight durability, labor savings and installation flexibility for commercial and residential geothermal applications. This easy to install and maintain custom manifold for ground-source geothermal loops offers the ultimate in labor savings and installation flexibility. It reduces labor due to its low number of parts and connections and saves space because of its compact design. The unit is lightweight, made of chemical and corrosion resistant PPR Type 3 engineered plastic, and is visually appealing. Most common configurations are available from stock, but Legend Hydronics will custom build to suit any application from 2-1/2" to 3-1/2" diameter and 4 to 26 loops for larger industrial and commercial applications. Header connections are available in threaded or new LegendPress™ style connections.

Key Features at a Glance

- Lightweight
- Labor saving
- Easy to install
- Compact installation
- Customer configurations available

GEOGREEN GEOTHERMAL MANIFOLD SYSTEM

M-8400 GeoGreen™	Part No.	List Price	Qty.
------------------	----------	------------	------

ISO 9002



GeoGreen M-8400 Geothermal™ Manifold Base Kit – Durable lightweight 2-1/2" geothermal manifolds. Contact Legend customer service for additional configurations.

8400-25-4	4 Port	75mm 2-1/2" Base Kit	Call for Quote
8400-25-6	6 Port	75mm 2-1/2" Base Kit	Call for Quote
8400-25-8	8 Port	75mm 2-1/2" Base Kit	Call for Quote

See accessories on page 122 and 123. Custom GeoGreen™ manifolds are available in configurations of 10 to 26 ports, up to 3-1/2" sizes.

Call Legend customer service at 866-752-2055 for assistance in specifying and ordering the GeoGreen™ M-8400 Manifold.

M-8400 GEOGREEN™ MANIFOLD

GeoGreen™ Manifold Base: Supply & return headers, 2 sets of brackets, and fill valve & air purger

Header Isolation Valves
(Red & Blue Pair)
FIP – 1-1/2" 822-857

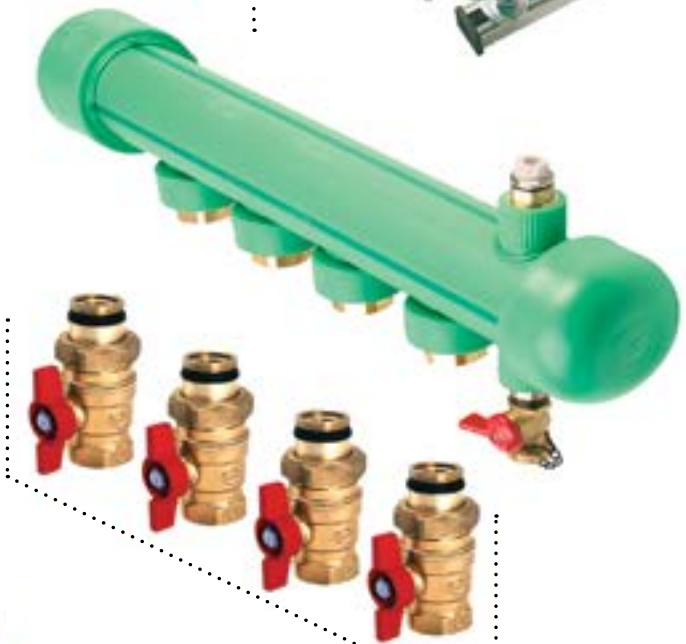

Header Isolation Valves
(Red & Blue Pair)
LegendPress™
1-1/2" 800-867



Loop Isolation Valves
(Red & Blue Pair)
1" 800-855

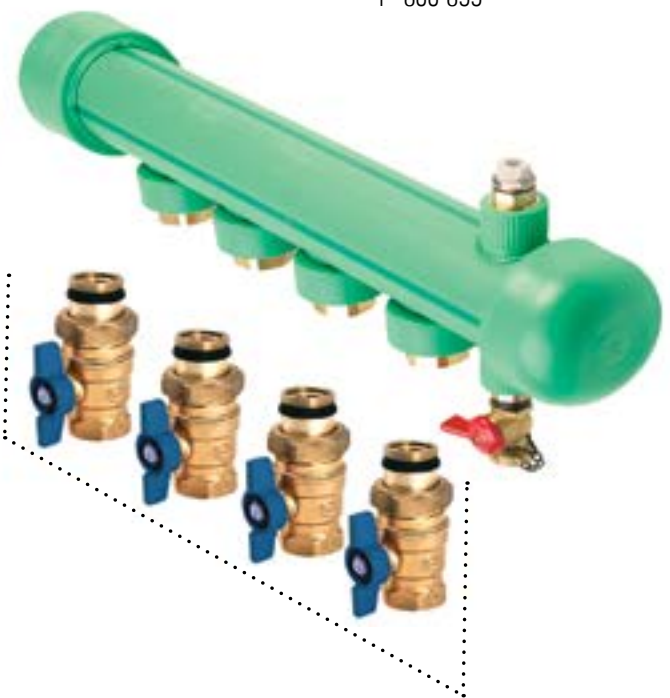

Loop Isolation Valves
with Thermometers
(Red & Blue Pair)
1" 800-855T



MANIFOLDS

M-8330

STAINLESS Manifold Series



Premium quality right out of the box.

Specifically designed with every feature thoughtfully considered and rigorously tested. The M-8330 stainless steel manifold is designed for use in hydronic heating and cooling systems. Premium quality stainless steel supply header has built-in flow meters to optimize design efficiencies. The return header has easy to actuate circuit isolation valves. All assembled parts have superior EPDM O-rings and seals. Each manifold is loosely pre-assembled for immediate mounting at the job site.

Key Features at a Glance

- Premium quality and enhanced features for the radiant professional
- Manufactured from premium 304 stainless steel
- Versatile and easily adaptable to a variety of mounting configurations
- EPDM O-rings and seals
- Built-in visual flow gauges for quick circuit performance verification
- The flow meters are easy to adjust using the red lock shield to set to the desired gpm
- Optional 4-wire actuators
- Angle isolation valve option for tight installations

Hydroforming process used to construct headers assures superior seal of supply and return isolation valves.

MANIFOLDS

M-8330 STAINLESS STEEL MANIFOLD

M-8330P Stainless Steel Pro	NEW	Part No.	List Price	Qty.
-----------------------------	-----	----------	------------	------

ISO 9002

M-8330P Stainless Steel Manifold Pro with automatic air vent and fill & purge adapter, supply & return isolation valves, each with thermometer. 1" Supply and return header.



8330P-10-2	2 Port	Stainless Steel Pro	337.00	1
8330P-10-3	3 Port	Stainless Steel Pro	392.00	1
8330P-10-4	4 Port	Stainless Steel Pro	448.00	1
8330P-10-5	5 Port	Stainless Steel Pro	503.00	1
8330P-10-6	6 Port	Stainless Steel Pro	560.00	1
8330P-10-7	7 Port	Stainless Steel Pro	618.00	1
8330P-10-8	8 Port	Stainless Steel Pro	680.00	1
8330P-10-9	9 Port	Stainless Steel Pro	751.00	1
8330P-10-10	10 Port	Stainless Steel Pro	820.00	1
8330P-10-11	11 Port	Stainless Steel Pro	891.00	1
8330P-10-12	12 Port	Stainless Steel Pro	961.00	1

M-8330 STAINLESS STEEL MANIFOLD

M-8330AP Stainless Steel Pro	NEW	Part No.	List Price	Qty.
------------------------------	-----	----------	------------	------

ISO 9002



M-8330AP Stainless Steel Manifold Angle Pro with automatic air vent and fill & purge adapter, supply & return isolation valves, each with thermometer. 1" supply and return header.

8330AP-10-2	2 Port	Stainless Steel Angle Pro	358.00	1
8330AP-10-3	3 Port	Stainless Steel Angle Pro	413.00	1
8330AP-10-4	4 Port	Stainless Steel Angle Pro	469.00	1
8330AP-10-5	5 Port	Stainless Steel Angle Pro	525.00	1
8330AP-10-6	6 Port	Stainless Steel Angle Pro	582.00	1
8330AP-10-7	7 Port	Stainless Steel Angle Pro	640.00	1
8330AP-10-8	8 Port	Stainless Steel Angle Pro	702.00	1
8330AP-10-9	9 Port	Stainless Steel Angle Pro	772.00	1
8330AP-10-10	10 Port	Stainless Steel Angle Pro	842.00	1
8330AP-10-11	11 Port	Stainless Steel Angle Pro	913.00	1
8330AP-10-12	12 Port	Stainless Steel Angle Pro	982.00	1

M-8330 Stainless Steel Basic	NEW
------------------------------	-----

ISO 9002



M-8330 Basic Stainless Steel Manifold with supply & return isolation valves, each with thermometer.

8330-10-2	2 Port	Stainless Steel Basic	279.00	1
8330-10-3	3 Port	Stainless Steel Basic	336.00	1
8330-10-4	4 Port	Stainless Steel Basic	392.00	1
8330-10-5	5 Port	Stainless Steel Basic	448.00	1
8330-10-6	6 Port	Stainless Steel Basic	506.00	1
8330-10-7	7 Port	Stainless Steel Basic	564.00	1
8330-10-8	8 Port	Stainless Steel Basic	627.00	1
8330-10-9	9 Port	Stainless Steel Basic	698.00	1
8330-10-10	10 Port	Stainless Steel Basic	768.00	1
8330-10-11	11 Port	Stainless Steel Basic	839.00	1
8330-10-12	12 Port	Stainless Steel Basic	909.00	1

Did you know? Legend ships every order complete or you will receive 5% off of the backorder.

M-8300E

ECONOMY Manifold



High quality and economical.

The M-8300E Economy Stainless Steel Manifold has been designed for use in place of field-built copper headers to reduce the installers labor and material costs. The 1" supply and return header are constructed of heavy walled 304 stainless steel. The economy manifold is simple and easy to use. Packaged loosely assembled for immediate installation. Includes mounting brackets, (2) MNPT header adapters and (2) header plugs. All Legend manifold accessories can be added to suit the specific job and design requirements.

M-8300E ECONOMY MANIFOLD

M-8300E Economy Manifold	AVAILABLE SEPT. 1	Part No.	List Price	Qty.
--------------------------	-------------------	----------	------------	------

ISO 9002

HYDRONIC SYSTEM COMPONENTS



M-8300E Economy Stainless Steel Manifolds

8300E-10-2	2 Port	Economy Manifold - 1" Headers	95.00	1
8300E-10-3	3 Port	Economy Manifold - 1" Headers	127.00	1
8300E-10-4	4 Port	Economy Manifold - 1" Headers	164.00	1
8300E-10-5	5 Port	Economy Manifold - 1" Headers	200.00	1
8300E-10-6	6 Port	Economy Manifold - 1" Headers	237.00	1
8300E-10-7	7 Port	Economy Manifold - 1" Headers	275.00	1
8300E-10-8	8 Port	Economy Manifold - 1" Headers	316.00	1
8300E-10-9	9 Port	Economy Manifold - 1" Headers	362.00	1
8300E-10-10	10 Port	Economy Manifold - 1" Headers	408.00	1
8300E-10-11	11 Port	Economy Manifold - 1" Headers	454.00	1
8300E-10-12	12 Port	Economy Manifold - 1" Headers	500.00	1

M-8300EV Economy Manifold

AVAILABLE SEPT. 1







ISO 9002

M-8300EV Economy Stainless Steel Manifold with Circuit Isolation Valves for supply header. Circuit isolation valves are not assembled onto header.



8300EV-10-2	2 Port	Economy Manifold with Valves	131.00	1
8300EV-10-3	3 Port	Economy Manifold with Valves	169.00	1
8300EV-10-4	4 Port	Economy Manifold with Valves	215.00	1
8300EV-10-5	5 Port	Economy Manifold with Valves	256.00	1
8300EV-10-6	6 Port	Economy Manifold with Valves	304.00	1
8300EV-10-7	7 Port	Economy Manifold with Valves	353.00	1
8300EV-10-8	8 Port	Economy Manifold with Valves	405.00	1
8300EV-10-9	9 Port	Economy Manifold with Valves	464.00	1
8300EV-10-10	10 Port	Economy Manifold with Valves	523.00	1
8300EV-10-11	11 Port	Economy Manifold with Valves	582.00	1
8300EV-10-12	12 Port	Economy Manifold with Valves	641.00	1

STAINLESS STEEL MANIFOLD ACCESSORIES

Isolation Valve	Part No.	List Price	Qty.
ISO 9002	Isolation Valve with Thermometer - For all Legend stainless steel manifolds.		
	833-855	Isolation Valve & Thermometer - Pair	140.65 -
	833-855B	Isolation Valve & Thermometer - Blue Handle	70.33 -
	833-855R	Isolation Valve & Thermometer - Red Handle	70.33 -
<hr/>			
Angle Isolation Valve			
ISO 9002	Angle Isolation Valve with Thermometer - For all Legend stainless steel manifolds.		
	833-825	Isolation Valve & Thermometer - Pair	162.46 -
	833-825B	Isolation Valve & Thermometer - Blue Handle	81.23 -
	833-825R	Isolation Valve & Thermometer - Red Handle	81.23 -
<hr/>			
Isolation Valve with Strainer			
ISO 9002	Isolation Valve with Thermometer & Y-Strainer - For all Legend stainless steel manifolds.		
	833-835R	Isolation Valve with Y-Strainer - Red Handle	110.87 -
<hr/>			
Purge Adapter			
ISO 9002	Air Vent, Water Purge Adapter - For all stainless steel manifolds. Includes automatic air vent and fill & purge valve, converts M-8330 to M8330P.		
	833-805	Chrome Plated Brass Air & Water Purge Adapter	55.79 -
<hr/>			
Circuit Actuator			
ISO 9002	4-Wire Circuit Actuator - 24 Volt with 36" leads. For all Legend stainless steel manifolds.		
	830-201	4-Wire circuit actuator with end switch	89.00 -
	830-201S	Replacement actuator adapter for stainless steel manifolds	5.00 -
<hr/>			
Manifold Union			
ISO 9002	Manifold Union - Connects any two stainless steel manifolds to increase circuit capacity. For all Legend stainless steel manifolds.		
	833-815	1" manifold union	8.42 -

STAINLESS STEEL MANIFOLD ACCESSORIES

Manifold Port Cap	Part No.	List Price	Qty.
-------------------	----------	------------	------

ISO 9002



Manifold Port Cap – Used to close and seal unused ports on any stainless steel manifolds. Includes EPDM O-ring. For Legend stainless steel manifolds.

833-141	Manifold Port Cap	6.32	-
---------	-------------------	------	---

Tube Connector

ISO 9002



Tube Connector – Used on all Legend stainless steel manifolds. Not for use with PEX-AL-PEX tube.

830-140	5/16" M-8300 Tube to Manifold Connector - Pair	10.19	-
830-142	3/8" M-8300 Tube to Manifold Connector - Pair	10.68	-
830-143	1/2" M-8300 Tube to Manifold Connector - Pair	10.71	-
830-144	5/8" M-8300 Tube to Manifold Connector - Pair	11.20	-
830-145	3/4" M-8300 Tube to Manifold Connector - Pair	24.64	-

Composite Tube Connector

ISO 9002



Tube Connector – Used on all Legend stainless steel manifolds. For use with PEX-AL-PEX tube.

830-142C	3/8" M-8300 Composite Tubing to Manifold Connector - Pair	10.92	-
830-143C	1/2" M-8300 Composite Tubing to Manifold Connector - Pair	11.20	-
830-144C	5/8" M-8300 Composite Tubing to Manifold Connector - Pair	11.76	-
830-145C	3/4" M-8300 Composite Tubing to Manifold Connector - Pair	22.00	-

Cold Expansion Tube Connector

ISO 9002, ASTM F 1960



Cold Expansion Tube Connector – For stainless steel manifolds. Installer must verify with tube manufacturer that the tubing is compatible with expansion type fitting systems. For all Legend stainless steel manifolds.

830-143P	1/2" Expansion PEX to Manifold Connector	26.20	-
----------	--	-------	---

Mounting Bracket

ISO 9002



Mounting Brackets – For all Legend stainless steel manifolds, with insulation pads. Made from heavy gauge steel for sturdy mounting and durability.

833-861	Mounting Bracket and Collar - Pair	29.47	-
---------	------------------------------------	-------	---

STAINLESS STEEL MANIFOLD ACCESSORIES

End Plug	Part No.	List Price	Qty.
----------	----------	------------	------

ISO 9002



End Plug with Gasket - Used for all Legend stainless steel manifolds to close and seal end.

833-845	1" Manifold End Plug	6.84	-
---------	----------------------	------	---

Flow Meter

ISO 9002



Replacement Flow Meter – For M-8330 stainless steel manifolds. Threads into top of supply header.

833-862	Flow Meter Assembly	21.32	-
---------	---------------------	-------	---

Did you know? Legend has comprehensive EDI and VMI capabilities.

LEGENDConnect™



The LEGENDConnect™ system is the ultimate in flexibility and convenience. The connectors are interchangeable with the T-88 Air & Dirt Separator, HS-808 Hydraulic Separator and LMV-3 Three-way Mixing Valve. Stock the bodies of any of these three models, then choose from a variety of connection types and sizes to meet the requirements of the project. From threaded and solder (sweat) to compact connections with built-in isolation valves; reduce inventory, improve service and handle all project requirements and installer preferences with one connection system - LEGENDConnect™.

Select your tube size and connector type. **Note** the body type (ie: A, B, C, etc.) Choose your product with the matching body type on page 133.

Pipe Size	Connector Type	Body	Connector Item	Qty	List Price
3/4"	MNPT	A	800-874M	Pair	20.00
3/4"	FNPT	A	800-874F	Pair	20.00
3/4"	Sweat	A	800-874S	Pair	17.00
3/4"	LegendPress	A	800-874LP	Pair	38.00
3/4"	Iso Valve Comp*	A	800-874VC	Pair	52.00
3/4"	Iso Valve FNPT*	A	800-874VF	Pair	50.00
1"	MNPT	A	800-875M	Pair	20.00
1"	Sweat	A	800-875S	Pair	17.00
1"	FNPT	B	800-875F	Pair	21.00
1"	LegendPress	B	800-875LP	Pair	50.00
1"	Iso Valve Comp	B	800-875VC	Pair	74.00
1"	Iso Valve FNPT	B	800-875VF	Pair	56.00
1-1/4"	MNPT	B	800-876M	Pair	33.00
1-1/4"	FNPT	B	800-876F	Pair	43.00
1-1/4"	Sweat	B	800-876S	Pair	28.00
1-1/4"	LegendPress	B	800-876LP	Pair	68.00
1-1/4"	Iso Valve FNPT	B	800-876VF	Pair	60.00
NEW 1-1/2"	FNPT	C	800-877F	Pair	80.00
NEW 1-1/2"	LegendPress	C	800-877LP	Pair	99.00
1-1/2"	MNPT	C	800-877M	Pair	85.00
1-1/2"	Sweat	C	800-877S	Pair	75.00

*These connectors include two connector nuts that should be used in place of the nuts included with the component bodies. Connectors are sold in pairs. **The HS-808 Hydraulic Separator requires 2 pair (4 total connectors).**

COMPONENT BODIES FOR USE WITH LEGENDCONNECT™

Air & Debris Eliminator (Body)

ISO 9002



T-88 High Performance Air and Debris Eliminator (Body Only) – Includes serviceable, automatic air vent w/ check valve adapter, purge valve and serviceable stainless steel screen. Connectors NOT included. See page 132 to order connectors separately.

Part No.	Body	List Price	Qty.
800-875	T-88 w/ Air Vent, Check, Fill & Purge Valve, Connector Nuts & Washer	Body A 240.00	1
800-876	T-88 w/ Air Vent, Check, Fill & Purge Valve, Connector Nuts & Washer	Body B 305.00	1
800-877	T-88 w/ Air Vent, Check, Fill & Purge Valve, Connector Nuts & Washer	Body C 375.00	1

Hydro-Separator (Body)

ISO 9002



HS-808 Hydraulic Separator (Body Only) – Includes serviceable, automatic air vent w/ check valve adapter, purge valve and insulation jacket. Connectors NOT included. See page 132 to order connectors separately. NOTE: Requires 2 pair of connectors (4 total).

800-835	HS-808 w/ Air Vent, Check, Fill & Purge Valve, Connector Nuts & Washers	Body A 616.00	1
800-836	HS-808 w/ Air Vent, Check, Fill & Purge Valve, Connector Nuts & Washers	Body B 700.00	1
800-837	HS-808 w/ Air Vent, Check, Fill & Purge Valve, Connector Nuts & Washers	Body C 930.00	1

Three-Way Mixing Valve (Body)



LMV-3 Three-Way Mixing Valve (Body Only) – Includes plastic cover for mixing actuator mounting threads and 1" compression nut for return port connection. Requires mixing valve actuator for proper system operation. Connectors NOT included. See page 132 to order connectors separately.

800-766	LMV-3 w/ Connector Nuts & Washers	Body B 187.50	1
---------	-----------------------------------	---------------	---

Components are to be used with the LEGENDConnect™ system. All component bodies listed here are sold without connectors. Choose the connector type and size on page 132 to match these bodies. To purchase kits that include the component body and specific connector type and size, see pages 134, 135 and 136.

T-88

High Performance Air and Debris Eliminator



The T-88 provides superior air and dirt elimination to help maximize efficiency and reduce noise in hydronic systems. The large bowl design combines with the internal stainless steel screen to separate entrained air, micro-bubbles and debris from the system fluid. The fluid velocity slows as it enters the larger volume of the T-88 bowl which allows the micro-bubbles and entrained air to separate from fluid, collect on the screen and/or float to the top of the bowl where it is eliminated from the system through the float type air vent. Also at this slower fluid velocity, the heavier dirt and debris particles separate and fall to the bottom of the bowl where it can later be blown out of the system through the purge valve.

The body of the T-88 is also bi-directional for adaptability in maximizing performance of the more critical function required by the particular system.



The T-88 is fully serviceable with a two piece bowl which allows for cleaning and/or replacement of the stainless steel screen.



The automatic high capacity air vent attaches to the T-88 through a check valve to allow removal without system pressure loss.



To maximize air removal, the larger half of the bowl should be on top.



To maximize debris removal, the larger half of the bowl should be on bottom.

T-88 HIGH PERFORMANCE AIR AND DEBRIS ELIMINATOR

T-88 Air & Dirt Removal Kit	Part No.	List Price	Qty.	
ISO 9002				
	800-884F	3/4" FNPT (Female) Hi-Performance Air Purger - Kit*	260.00	1
	800-884M	3/4" MNPT (Male) Hi-Performance Air Purger - Kit*	260.00	1
	800-884S	3/4" SWT (Solder) Hi-Performance Air Purger - Kit*	257.00	1
	800-884P	3/4" LegendPress™ Hi-Performance Air Purger - Kit*	278.00	1
	800-884VC	3/4" Iso Valve Comp Hi-Performance Air Purger - Kit*	292.00	1
	800-884VF	3/4" Iso Valve FNPT (Female) Hi-Performance Air Purger - Kit*	290.00	1

T-88 High Performance Air and Debris Eliminator Kits - Maximum performance, serviceability, and flexibility. Includes serviceable, automatic air vent with check valve adapter, purge valve, and serviceable stainless steel screen. Connectors are included in all kits listed below.

T-88 HIGH PERFORMANCE AIR AND DEBRIS ELIMINATOR

T-88 Air & Dirt Removal Kit (cont.)

ISO 9002

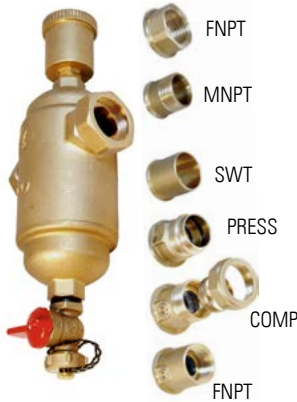

Part No.		List Price	Qty.
800-885F	1" FNPT (Female) Hi-Performance Air Purger - Kit*	326.00	1
800-885M	1" MNPT (Male) Hi-Performance Air Purger - Kit	260.00	1
800-885S	1" SWT (Solder) Hi-Performance Air Purger - Kit	257.00	1
800-885P	1" LegendPress™ Hi-Performance Air Purger - Kit*	355.00	1
800-885VC	1" Iso Valve Comp Hi-Performance Air Purger - Kit*	379.00	1
800-885VF	1" Iso Valve FNPT (Female) Hi-Performance Air Purger - Kit*	361.00	1
800-886F	1-1/4" FNPT (Female) Hi-Performance Air Purger - Kit	348.00	1
800-886M	1-1/4" MNPT (Male) Hi-Performance Air Purger - Kit	338.00	1
800-886S	1-1/4" SWT (Solder) Hi-Performance Air Purger - Kit	333.00	1
800-886P	1-1/4" LegendPress™ Hi-Performance Air Purger - Kit	373.00	1
800-886VF	1-1/4" Iso Valve FNPT (Female) Hi-Performance Air Purger - Kit	365.00	1
NEW 800-887F	1-1/2" FNPT (Female) Hi-Performance Air Purger - Kit	455.00	1
800-887M	1-1/2" MNPT (Male) Hi-Performance Air Purger - Kit	460.00	1
800-887S	1-1/2" SWT (Solder) Hi-Performance Air Purger - Kit	450.00	1
NEW 800-887P	1-1/2" LegendPress™ Hi-Performance Air Purger - Kit	474.00	1

*Uses next larger size body style

Did you know? Legend does not have a minimum order.

HS-808

Hydraulic Separator

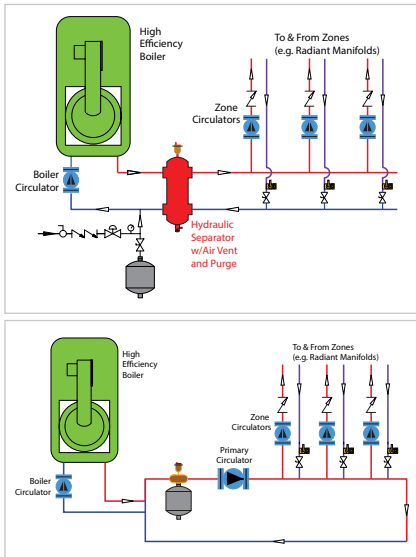

The HS-808 allows for a simple, efficient and economical method of “hydraulic” separation in hydronic systems. Enjoy all the benefits of “primary/secondary” system piping; eliminate circuit to circuit (zone distribution) and circuit to heating or cooling source flow (hydraulic) interference and simplify system design and analysis; without the complicated and costly “close spaced tees” piping. In many cases the use of a hydraulic separator eliminates the need for a “primary” circulator, and the installation and operating cost associated with it. Additional benefits of the HS-808 include system air removal via the included automatic high capacity air vent and debris collection and removal via the included purge valve. All sizes feature union connections for ease of installation and maintenance. Attractive, compact and form fitting insulation is provided with each unit.

Key Features at a Glance

- High capacity field serviceable automatic air vent has built-in check valve
- Garden hose thread clean-out valve
- Union style connections
- Compact insulation jacket
- Use LEGENDConnect™ system

The HS-808 simplifies system piping for easier installation, design and analysis. In many cases eliminating the need for a “primary” circulator.

HS-808 HYDRAULIC SEPARATOR

HS-808 Kit

ISO 9002



Part No.	List Price	Qty.
HS-808 Hydraulic Separator Kits - Includes serviceable automatic air vent with check valve adapter, purge valve and insulation jacket. Connectors included in all kits list below.		
800-835M	1" MNPT (Male) Hydraulic Separator - Kit	656.00 1
800-835F	1" FNPT (Female) Hydraulic Separator - Kit*	742.00 1
800-835S	1" SWT (Solder) Hydraulic Separator - Kit	650.00 1
800-835P	1" LegendPress™ Hydraulic Separator - Kit*	800.00 1
800-835VC	1" Isolation Valve Comp Hydraulic Separator - Kit*	848.00 1
800-835VF	1" Isolation Valve FNPT Hydraulic Separator - Kit*	812.00 1
800-836M	1-1/4" MNPT (Male) Hydraulic Separator - Kit	766.00 1
800-836F	1-1/4" FNPT (Female) Hydraulic Separator - Kit	786.00 1
800-836S	1-1/4" SWT (Solder) Hydraulic Separator - Kit	756.00 1
800-836P	1-1/4" LegendPress™ Hydraulic Separator - Kit	836.00 1
800-836VF	1-1/4" Isolation Valve FNPT Hydraulic Separator - Kit	820.00 1
800-837M	1-1/2" MNPT (Male) Hydraulic Separator - Kit	1100.00 1
NEW 800-837F	1-1/2" FNPT (Female) Hydraulic Separator - Kit	1090.00 1
800-837S	1-1/2" SWT (Solder) Hydraulic Separator - Kit	1080.00 1
NEW 800-837P	1-1/2" LegendPress™ Hydraulic Separator - Kit	1128.00 1
800-837U	1-1/2" Union Hydraulic Separator - Kit**	990.00 1
800-838U	2" Union Hydraulic Separator - Kit**	1250.00 1

*Uses next larger size body style

**Not part of the LEGENDConnect™ system

T-88 & HS-808 ACCESSORIES

T-88 Air & Dirt Removal Kit



T-88 Magnetic Debris Remover – The magnet and housing replaces the automatic air vent on the top port of the bowl and slides down through the center of the internal stainless steel screen. During operation of the hydronic system, the magnet generates a powerful magnetic field that attracts ferrous debris out of the fluid stream as it passes through the body of the T-88. This is especially effective in older hydronic systems that contain steel or iron piping, cast iron radiators and/or cast iron boilers where ferrous oxide corrosion may have built up within system components over time. The magnet can be removed from the housing. Debris adhering to the housing is then released and is cleaned.

Part No.	List Price	Qty.
800-881	T-88 Magnetic Debris Remover w/ Housing	85.00 1

Expansion Tank / Fill Valve Tee



Expansion Tank / Fill Valve System Connection – Designed to allow easy connection of an expansion tank and/or automatic fill valve (make-up water) to the hydronic system. The tee provides a convenient piping attachment point (1/2" MNPT), into the system, attaching to the top port of either the T-88 Air & Debris Eliminator or the HS-808 Hydraulic Separator, automatic air vent check valve attaches to the other end of the tee.

800-246	Expansion Tank / Fill Valve Tee Connector - 1/2" MNPT	38.00 1
---------	---	---------

Fill and Purge Valve



Replacement Fill & Purge Valve – Replacement fill & purge valve for T-88 and HS-808. Quarter-turn ball valve with tethered cap, garden hose thread (GHT) connection and EPDM gasket/O-ring seals.

800-802	Replacement Fill & Purge Valve	24.00 1
---------	--------------------------------	---------

Air Vent



High Capacity Air Vent – Replacement air vent for T-88 and HS-808. Vent can be serviced by unthreading the cap.

800-245	Replacement High Capacity Air Vent with Check Valve	35.00 1
---------	---	---------

LMV-3 Three Way Mixing Valve



LMV-3 Three-Way Mixing Valve, is designed for use in hydronic heating and cooling systems. This valve is designed to provide a desired system fluid temperature by mixing fluid at a higher temperature from the heat source (typically a boiler) with fluid at a lower temperature returning from the heating zone. For cooling applications it can be installed to mix cooler fluid from the chiller (or other cooling water sources) with warmer fluid returning from the zones to achieve the desired system chilled fluid temperature.

Key Features at a Glance

- "Stand alone" option available
- Compatible with most popular mixing controllers
- Capable of "outdoor reset" or "set point" mixing strategies
- Economical method to employ multiple water temperatures on same project
- Utilizes LEGENDConnect™ system for variety of installation options

LMV-3 Three-Way Mixing Valve	Part No.	List Price	Qty.	
<ul style="list-style-type: none"> FNPT MNPT SWT PRESS COMP FNPT 	LMV-3 Three-Way Mixing Valve Kit – Requires mixing valve actuator for proper system operations. Connector included in all kits listed below.			
	800-765F	1" FNPT (Female) 3-way Mixing Valve - Kit	208.50	1
	800-765P	1" LegendPress™ 3-way Mixing Valve - Kit	237.50	1
	800-765VC	1" Iso Valve Compression 3-Way Mixing Valve - Kit	261.50	1
	800-765VF	1" Iso Valve FNPT (Female) 3-Way Mixing Valve - Kit	243.50	1
	800-766M	1-1/4" MNPT (Male) 3-Way Mixing Valve - Kit	220.50	1
	800-766S	1-1/4" SWT (Solder) 3-Way Mixing Valve - Kit	215.50	1
	800-766F	1-1/4" FNPT (Female) 3-way Mixing Valve - Kit	230.50	1
	800-766P	1-1/4" LegendPress™ 3-Way Mixing Valve - Kit	255.50	1
	800-766VF	1-1/4" Iso Valve FNPT (Female) 3-Way Mixing Valve - Kit	247.50	1

Mixing Valve Actuator



Mixing Valve Actuators are compact and a very reliable design for use with the LMV-3 mixing valve. Two control options are available to utilize either "set point" or "outdoor reset" mixing strategies. Utilizes knurled brass nut for easy connection to the 3-way valve and colored LED lights to visually indicate movement and direction of actuator.

24V Floating Actuator – For use with the LMV-3 Mixing Valve. Must be paired with separate controller that can provide a 24V output signal (sold separately).

800-761	Mixing Valve Actuator – 24V Floating	254.16	1
---------	--------------------------------------	--------	---



Stand-Alone Actuator – For use with the LMV-3 Mixing Valve. Contains built-in, proportional – integral (PI) control that uses feedback from the pre-wired temperature probe (included) to control position of 3-way mixing valve for desired output temperature. No need to connect to separate control box or system.

800-762	Mixing Valve Actuator - Stand Alone	436.66	1
---------	-------------------------------------	--------	---

AF-480

Auto Fill With Backflow Preventer



The AF-480 reduces the feed pressure from the make-up system to the lower operating pressure of the hydronic system. The backflow preventer allows for a safe connection between the two systems by preventing any possibility of back flow from the hydronic system into the potable water system. Set up is simple with the built-in pressure gauge; just dial in the desired system pressure to be maintained; from 7 to 45 psi. The gauge can be mounted on either side of the assembly for easy viewing in any mounting direction. The pressure reducing valve is fully serviceable with removable filter cartridge for easy cleaning or replacement.

Key Features at a Glance

- Built-In system pressure gauge
- Adjustable from 7 to 45 psi (pre-set to 12 psi)
- Fully serviceable with removable filter cartridge
- ASSE 1012 certified to meet local codes

Auto Fill with Backflow & Gauge	Part No.	Size	List Price	Qty.
 <p>AF-480 Auto Fill with Backflow Preventer & Gauge – Compact, safe and easy to install automatic make-up water assembly.</p>				
	800-841	1/2"	Auto Fill with Backflow and Gauge - FNPT	190.00 1
	800-842	1/2"	Auto Fill with Gauge Only - FNPT	121.00 1

HYDRONIC SYSTEM COMPONENTS

Did you know? Legend ships every order within 24 hours guaranteed or you will receive 5% off of the order.

Heat Exchangers



Legend's BPHE is compatible with a variety of media:

- Water
- Oil
- Organic solvents
- Various antifreeze solutions (glycol mixtures, alcohols, etc.)

Legend's BPHE is designed to be used in a variety of applications; to include, but not limited to:

- Hydronic heating and cooling (radiant floor, snow & ice melt)
- Domestic water heating
- Industrial fluid processing
- Solar/Geothermal applications

Legend's HX Series Brazed Plate Heat Exchangers (BPHE) consist of acid-resistant stainless steel plates with a herringbone ridge pattern. The plates are arranged so that this pattern is in the opposite direction on each adjacent plate. At every point where the ridges intersect a copper vacuum brazed joint exists forming a separate flow path for the two media that exchange heat energy. The counter-current flow paths of the media and the vigorous turbulence caused by the ridges ensure maximum heat transfer.

Key Features at a Glance

- U.L. Listed
- High thermal efficiency
- High temperature (302° F) and pressure (435 psi) resistance
- High thermal efficiency
- High corrosion resistance
- No gasket seals
- Excellent flow characteristics
- Easy installation and less maintenance
- Very durable

HYDRONIC SYSTEM COMPONENTS

Heat Exchanger	Part No.	Size	List Price	Qty.
----------------	----------	------	------------	------



HX Series Heat Exchangers – Brazed plate heat exchanger (BPHE) 5" x 12" with MNPT connections and acid-resistant stainless steel plates.

807-001	3/4"	HX-100, 10 Plate; 50M BTU/H	363.80	1
807-071	1"	HX-100, 10 Plate; 50M BTU/H	380.00	1
807-002	3/4"	HX-200, 20 Plate; 100M BTU/H	562.28	1
807-072	1"	HX-200, 20 Plate; 100M BTU/H	575.00	1
807-003	3/4"	HX-300, 30 Plate; 150M BTU/H	811.80	1
807-073	1"	HX-300, 30 Plate; 150M BTU/H	831.00	1

Compact Heat Exchanger



HX Series Compact Heat Exchangers – Brazed plate heat exchanger (BPHE) 3" x 7-1/2" with 3/4" MNPT connections and acid-resistant stainless steel plates.

807-031	3/4"	HX-100B, 10 Plate; 40M BTU/H	230.00	1
807-032	3/4"	HX-160B, 16 Plate; 70M BTU/H	295.00	1
807-033	3/4"	HX-200B, 20 Plate; 90M BTU/H	350.00	1

Zone Valves



Zone Valves LZV-2 and LZV-3 series motorized valves are used to control flow in chilled or hot water systems and low pressure steam systems up to 15 psi. The valve is driven by a hysteresis synchronous motor with spring return. Normally open actuator models are available upon request.

Key Features at a Glance

- Suitable for heating/cooling or low pressure steam systems
- Long life synchronous motor
- Stainless steel shaft with EPDM ball and seals
- Can be used on applications with high make up water
- Locking connection between valve body and actuator
- High differential pressure close-off, low noise

2-Way Zone Valve	Part No.	Size	List Price	Qty.
------------------	----------	------	------------	------

ISO 9002



LZV-2 Series Motorized Valve – 2-way zone valve, normally closed, solder (sweat) connection.

800-703	1/2"	With End Switch, 3.8 CV Factor	126.36	1
800-704NE	3/4"	Without End Switch, 5.4 CV Factor	115.50	1
800-704	3/4"	With End Switch, 5.4 CV Factor	124.95	1
800-705	1"	With End Switch, 8.0 CV Factor	137.55	1
800-706	1"	With End Switch, 11.7 CV Factor	208.95	1
800-710		Normally Open Actuator	78.75	1
800-709		Replacement 4-Wire Actuator	78.75	1

Order as replacement part for LZV-2 Series

3-Way Zone Valve

ISO 9002



LZV-3 Series Motorized Valve – 3-way zone valve, solder (sweat) connection.

800-713	1/2"	3.8 CV Factor	127.05	1
800-714	3/4"	5.4 CV Factor	131.25	1
800-715	1"	6.7 CV Factor	152.25	1
800-716	1-1/4"	9.8 CV Factor	241.50	1
800-719		Replacement 2 Wire Actuator	78.75	1

Order as replacement part for LZV-3 Series

HYDRONIC SYSTEM COMPONENTS

Gauges



Key Features at a Glance

- Adjustable reference temperature
- 0-75 psi
- 0-170 feet of head
- 40-200°F range option optimized for hydronic heating and cooling applications or 60-280°F temperature range standard option

GAUGES

Rear Mount Gauge	Part No.	Size		List Price	Qty.
------------------	----------	------	--	------------	------

ISO 9001



T-825 Rear Mount Temperature and Pressure Gauge, MNPT.

800-662	1/4"	40-200° F Range	29.00	1
800-663	1/2"	40-200° F Range	30.00	1
800-673	1/2"	60-280° F Range	31.00	1

Bottom Mount Gauge

ISO 9001



T-825 Bottom Mount Temperature and Pressure Gauge, MNPT.

800-664	1/4"	40-200° F Range	29.00	1
800-665	1/2"	40-200° F Range	31.50	1
800-675	1/2"	60-280° F Range	31.00	1

Extended Probe Rear Mount

ISO 9001



T-825 Rear Mount Extended Probe Temperature and Pressure Gauge 1/2" MNPT, 3" Probe.

800-683	1/2"	60-280° F Range	31.00	1
---------	------	-----------------	-------	---

Extended Probe Bottom Mount

ISO 9001



T-825 Bottom Mount Extended Probe Temperature and Pressure Gauge 1/2" MNPT, 3" Probe.

800-684	1/2"	60-280° F Range	31.00	1
---------	------	-----------------	-------	---

GAUGES

2-1/2" Rear Mount Gauge

ISO 9001



T-825 Rear Mount Temperature and Pressure Gauge 2-1/2" Gauge ideal for boiler replacements. MNPT.

Part No.	Size		List Price	Qty.
800-692	1/4"	60–280° F Range	23.00	1
800-693	1/2"	60–280° F Range	25.00	1

T-820 TEST GAUGES

Side Mount Tester

ISO 9001



T-820 Air Pressure Tester, Side Mount - 100 psi, built in Schraeder valve.

800-669	3/4"	FNPT Side Mount Air Pressure Tester	36.00	1
800-668	1"	MNPT Side Mount Air Pressure Tester	30.75	1

End Mount Tester

ISO 9001



T-820 Air Pressure Tester, end mount style is great for low profile applications. 1" thread MNPT allows direct connection to manifold, 0-100 psi built in Schraeder valve.

800-667	1"	MNPT End Mount Air Pressure Tester	30.75	1
---------	----	------------------------------------	-------	---

Water Pressure Tester

ISO 9001



T-820 Water Pressure Tester, garden hose thread connection to allow for easy plumbing system pressure testing.

800-660	3/4"	GHT Water Pressure Tester	14.00	1
---------	------	---------------------------	-------	---

Temperature Gauge with Thermowell

ISO 9001



Temperature Gauge with Thermowell – 1" probe, 60°F - 280°F. Temperature gauge is easily removable without loss of system pressure.

800-653	2"	1/2" MNPT Thermowell	18.90	1
800-652	3"	1/2" MNPT Thermowell	21.00	1
800-655	2"	3/4" Solder Thermowell	21.00	1
800-654	3"	3/4" Solder Thermowell	21.99	1

AMBIANCE™



Radiant heating and cooling ceiling panels

AMBIANCE™ is a ceiling based radiant panel system that can be used for heating or cooling applications. AMBIANCE™ consists of 2x2 or 2x4 steel panels that fit in standard suspended ceiling grid systems. The panels incorporate aluminum heat transfer plates that conduct heat to or from the panel surface. Copper or PEX tube is connected to the heat transfer plates via flexible braided connectors. The panels are then connected in series to a manifold supplying heated or chilled water.

An AMBIANCE™ system can easily accommodate as many temperature zones and controls as needed.

Key Features at a Glance

- Fits in standard 2x2 and 2x4 ceiling grid systems
- Works for heating and cooling applications
- Great for new construction or existing ceiling retrofits
- Great for large, multi-level buildings or smaller residential spaces
- Excellent supplemental heat for foyers, basements, entryways, etc.



AMBIANCE™ panels can be used for commercial environments supplying zoned heating and cooling efficiently. In multi-floor buildings, AMBIANCE™ can reduce plenum space and result in 5-10% more usable building space. AMBIANCE™ panels can be used to provide supplemental heat in small spaces where design constraints do not allow for sufficient heat. Entryways, foyers, bathrooms, and windowed areas are common applications where supplemental heat is needed to provide comfort.

MECHPanels™



Designed and manufactured to fit your project specifications

The Legend Hydronics MechPanels™ are assembled and tested in our factory and shipped direct to the project ready for installation. All Legend Hydronics MechPanels are temperature and pressure tested to ensure leak free, quality connections. All wiring and electrical connections & circuits are also 100% tested*. Why spend unnecessary time at the jobsite when you can simply hang the MechPanel on the wall, make the major connections, commission the project and leave. The Legend Hydronics MechPanels will save you time and money.

Service manual included – wiring and piping schematics, equipment specifications, unpacking, installation, and operation instructions.

Key Features at a Glance

- Zone Distribution – with circulators and/or valves
- Primary Piping - heating/cooling source included
- Residential projects
- Commercial Skids – snow & ice melt systems
- Controls included and pre-wired



Our MechPanels™ offer a “just right” solution for every project whatever the scale.

MechPanels™ use stainless steel backing for an attractive, clean, professional appearance.

SUNSTATION™

Legend Hydraulics' space and labor saving SP-20 SunStation™ Pump System is state of the art.

The "heart" of any solar thermal heating system is its pump system and SunStation's compact, lightweight design makes it easy to install and maintain. The insulation shell ensures effective thermal insulation, easy access and an attractive appearance. Proven for many years in European applications, the cost-effective SunStation™ Pump includes flow gauge, fill & purge valves, circulator, balancing valve, supply & return isolation valves with built-in check, manual air vent, supply & return temperature gauges, pressure gauge and pressure relief valve with drain port.

Key Features at a Glance

- Isolation valves with integrated thermometers
- 2 piece insulation shell included
- Electronic control unit (ordered separately)
- Built-in flow meter
- Fill and purge valves
- Pressure relief with drain port

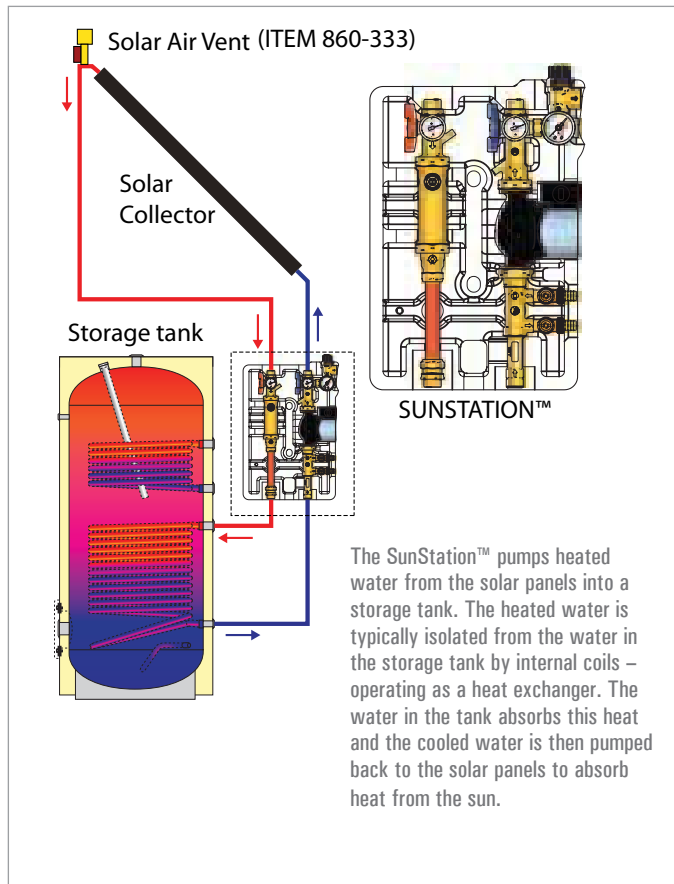
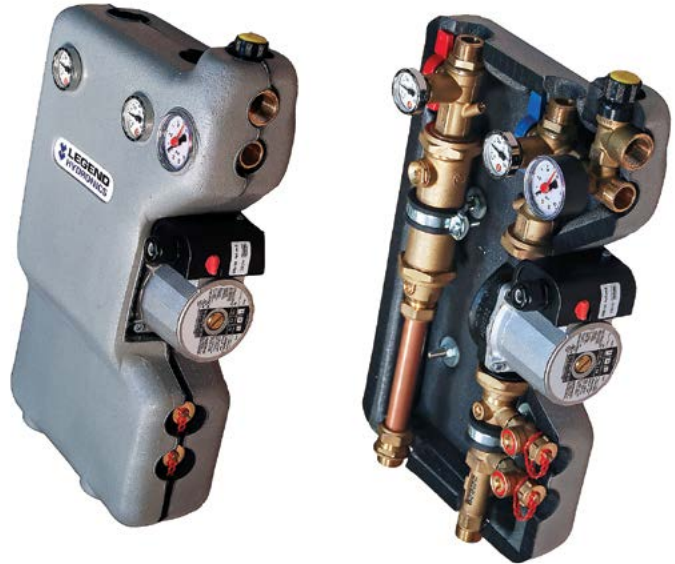

The SP-20 Unit provides automatic control of the solar pumping station. The unit monitors temperature sensors mounted on the solar panels and in the storage tank. When the solar panel temperature is greater than the storage tank, the pump operates, heating the water in the tank. At night or in cold conditions the pump remains off, preserving the heat accumulated in the tank. The controller also logs operating parameters providing information on the amount of energy saved and collected over time.



SunStation™ Compact Solar Pumping Station

ISO 9002



SP-20 Dual line solar pump

Includes flow gauge, fill & purge valves, circulator, balancing valve, supply & return isolation valves with built-in check, manual air vent, supply & return temperature gauges, pressure gauge and pressure relief valve with drain port.

Part No. 860-020

List Price 1575.00

Connection Kit for SP-20 SunStation™

ISO 9002



Connection Kit for SP-20 SunStation™ – Contains 6 adapters for panel supply & return, tank supply/return, expansion tank, and overpressure blow-off.

	Part No.	List Price
1/2" Compression Connection Kit	860-023	90.00
3/4" Compression Connection Kit	860-024	115.00
1" Compression Connection Kit	860-025	165.00

Control Unit for SP-20 SunStation™

ISO 9002



SP-20 Electronic Control Unit

The SP-20 Electronic Control provides automatic control of the SP-20 SunStation™.

Part No. 860-100

List Price 625.00

Air Vent

ISO 9002



Solar Air Vent and Valve Kit

Air Vent – High temperature (356° F) and high capacity air vent for solar applications. Includes isolation ball valve for servicing air vent.

Part No. 860-333

List Price 105.45

VersaTherm™



Main Panels (VT-MP)

Panel Size = 31-1/2 in. x 15-3/4 in. = (496) 3.44 ft² (10 panels per box)

Use to calculate number of panels:

$$\frac{\text{Project square footage}}{\text{Number of main panels needed}} \times 0.233 = \text{Number of main panels needed} \text{ (Round Up)}$$

EXAMPLE: 400 ft² x 0.233 = 93.2 or (94)

Use to calculate number of cases:

$$\frac{\text{Number of main panels needed}}{\text{Number of cases needed}} \div 10 = \text{Number of cases needed} \text{ (Round Up)}$$

EXAMPLE: 94 panels ÷ 10 = 9.4 or (10) boxes



Return Panels (VT-RP)

Panel Size = 15-3/4 in. x 15-3/4 in. = (248) 1.72 ft² (20 panels per box)

Use to calculate number of panels:

$$\frac{\text{Project square footage}}{\text{Number of main panels needed}} \times 0.117 = \text{Number of main panels needed} \text{ (Round Up)}$$

EXAMPLE: 400 ft² x 0.117 = 46.8 or (47)

Use to calculate number of cases:

$$\frac{\text{Number of main panels needed}}{\text{Number of cases needed}} \div 20 = \text{Number of cases needed} \text{ (Round Up)}$$

EXAMPLE: 47 panels ÷ 20 = 2.35 or (3) boxes

QuickTherm™



QT100 (1") Panel Size = 2' x 4' = 8 ft² (18 panels per bundle)

QT200 (2") Panel Size = 2' x 4' = 8 ft² (10 panels per bundle)

Use to calculate number of panels:

$$\frac{\text{Project square footage}}{\text{Number of QT panels needed}} \div 8 = \text{Number of QT panels needed} \text{ (Round Up)}$$

EXAMPLE: 3500 ft ÷ 8 = 437.5 or (438) panels

Use to calculate number of bundles:

$$\frac{\text{Number of QT panels needed}}{\text{Number of bundles needed}} \div (18 \text{ or } 10) = \text{Number of bundles needed} \text{ (Round Up)}$$

EXAMPLE: 438 ÷ 10 (QT 200) = 43.8 or (44) bundles

Notes: The project square footage includes only the area of the room or project space that is to be covered by tubing. Do not include areas under cabinets or any areas that will not receive tubing.

PROJECT DESIGN IS HIGHLY RECOMMENDED WITH VERSATHERM.

Downstream Thinking[®] guarantees you
the right product when you need it.



1954 HDPE
(HIGH DENSITY POLYETHYLENE)
TUBE FIRST TESTED



1965 ENGEL PATENT, PEXa



1967 PEXa PRODUCTION
FOR POTABLE
WATER SYSTEMS



1981 PE-RT
FIRST DEVELOPED



1984 ASTM F 876/877
PUBLISHED

HyperPure™ Bimodal Polyethylene Raised Temperature (PE-RT) tubing is strong, flexible and pure. Utilizing modern resin technology HyperPure™ is the first flexible plastic hot and cold water tube that does not need to be crosslinked. No additional additives or processes are necessary making the tube pure, 100% recyclable and fusible.

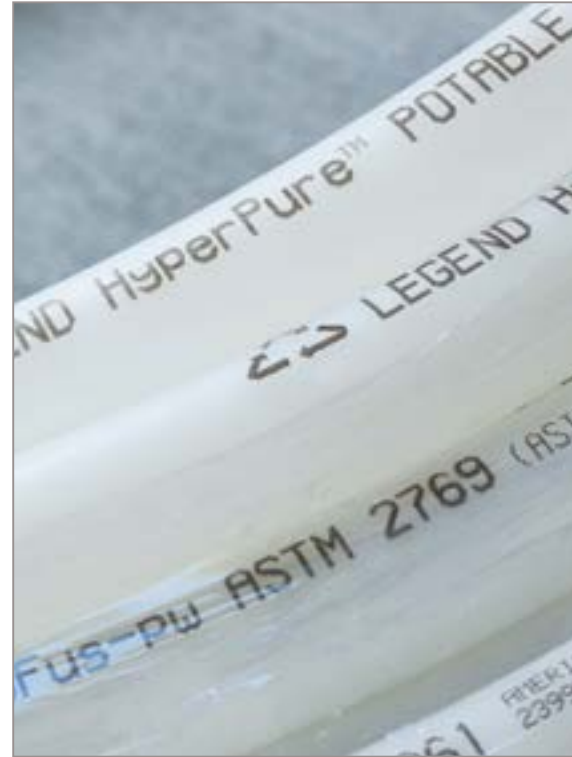

1989 CSA 137.5 PUBLISHED FOR PEXb & PEXc



2005 PEX USAGE OVERTAKES COPPER IN US



2009 CALIFORNIA APPROVES PEX



2012 DOW PATENTS HYPERPURE™ 2399 ADDED TO IPC & UPC PLUMBING CODE



2015 LEGEND MANUFACTURES PE-RT POTABLE WATER TUBING

HyperPure™

200 psi @ 73°F
100 psi @ 180°F
cNSFus-pw
ASTM 2769 (ASTM
876/877 equivalent)



CL 5 (chlorine level 5)
AWWA C901
CSA B137.18
SDR-9

Certification & Packaging Information

IPC, UPC 2012 and 2015 National plumbing codes, certified by ICC - ES PMG to IPC, IRC and UPC

HyperPure™ coils are shrink-wrapped in UV-resistant plastic. The tubing can be pulled from the center of the coil while the wrap holds the tube from uncoiling.

HyperPure™ coils and sticks are marked from 0 feet to its total length in 5 foot increments. This allows the installer to know exactly how much tube he is using so he can minimize any scrap material.

Compliant with fittings specified by ASTM F 1807 / 2098 / 2159 / 2080



HyperPure™ 1/4" & 3/8" PE-RT Tubing	NEW	Part No.	Size	Configuration	Length	List Price	Pack
-------------------------------------	-----	----------	------	---------------	--------	------------	------



500-14-100	1/4"	Bi-modal PE-RT Tube 100' Coil Natural	100'	51.00	1
500-38-100	3/8"	Bi-modal PE-RT Tube 100' Coil Natural	100'	56.20	1
500-38-500	3/8"	Bi-modal PE-RT Tube 500' Coil Natural	500'	281.00	1
500-38-1000	3/8"	Bi-modal PE-RT Tube 1000' Coil Natural	1000'	562.00	1

HyperPure™ 1/2" PE-RT Tubing	NEW
------------------------------	-----





500-12-10	1/2"	Bi-modal PE-RT Tube 10' Stick Natural	10'	4.94	25
500-12-10B	1/2"	Bi-modal PE-RT Tube 10' Stick Blue	10'	4.94	25
500-12-10R	1/2"	Bi-modal PE-RT Tube 10' Stick Red	10'	4.94	25
500-12-20	1/2"	Bi-modal PE-RT Tube 20' Stick Natural	20'	9.88	25
500-12-20B	1/2"	Bi-modal PE-RT Tube 20' Stick Blue	20'	9.88	25
500-12-20R	1/2"	Bi-modal PE-RT Tube 20' Stick Red	20'	9.88	25
500-12-100	1/2"	Bi-modal PE-RT Tube 100' Coil Natural	100'	49.40	1
500-12-100B	1/2"	Bi-modal PE-RT Tube 100' Coil Blue	100'	49.40	1
500-12-100R	1/2"	Bi-modal PE-RT Tube 100' Coil Red	100'	49.40	1
500-12-300	1/2"	Bi-modal PE-RT Tube 300' Coil Natural	300'	148.20	1
500-12-300B	1/2"	Bi-modal PE-RT Tube 300' Coil Blue	300'	148.20	1
500-12-300R	1/2"	Bi-modal PE-RT Tube 300' Coil Red	300'	148.20	1
500-12-500	1/2"	Bi-modal PE-RT Tube 500' Coil Natural	500'	247.00	1
500-12-500B	1/2"	Bi-modal PE-RT Tube 500' Coil Blue	500'	247.00	1
500-12-500R	1/2"	Bi-modal PE-RT Tube 500' Coil Red	500'	247.00	1
500-12-1000	1/2"	Bi-modal PE-RT Tube 1000' Coil Natural	1000'	494.00	1
500-12-1000B	1/2"	Bi-modal PE-RT Tube 1000' Coil Blue	1000'	494.00	1
500-12-1000R	1/2"	Bi-modal PE-RT Tube 1000' Coil Red	1000'	494.00	1

HyperPure™ 3/4" PE-RT Tubing	NEW
------------------------------	-----





500-34-10	3/4"	Bi-modal PE-RT Tube 10' Stick Natural	10'	9.12	25
500-34-10B	3/4"	Bi-modal PE-RT Tube 10' Stick Blue	10'	9.12	25
500-34-10R	3/4"	Bi-modal PE-RT Tube 10' Stick Red	10'	9.12	25
500-34-20	3/4"	Bi-modal PE-RT Tube 20' Stick Natural	20'	18.23	25
500-34-20B	3/4"	Bi-modal PE-RT Tube 20' Stick Blue	20'	18.23	25
500-34-20R	3/4"	Bi-modal PE-RT Tube 20' Stick Red	20'	18.23	25
500-34-100	3/4"	Bi-modal PE-RT Tube 100' Coil Natural	100'	91.15	1
500-34-100B	3/4"	Bi-modal PE-RT Tube 100' Coil Blue	100'	91.15	1

HyperPure™ 3/4" PE-RT Tubing (cont.)		NEW	Part No.	Size	Configuration	Length	List Price	Pack
	500-34-100R	3/4"	Bi-modal PE-RT Tube 100' Coil Red	100'	91.15	1		
	500-34-300	3/4"	Bi-modal PE-RT Tube 300' Coil Natural	300'	273.45	1		
	500-34-300B	3/4"	Bi-modal PE-RT Tube 300' Coil Blue	300'	273.45	1		
	500-34-300R	3/4"	Bi-modal PE-RT Tube 300' Coil Red	300'	273.45	1		
	500-34-500	3/4"	Bi-modal PE-RT Tube 500' Coil Natural	500'	455.75	1		
	500-34-500B	3/4"	Bi-modal PE-RT Tube 500' Coil Blue	500'	455.75	1		
	500-34-500R	3/4"	Bi-modal PE-RT Tube 500' Coil Red	500'	455.75	1		
	500-34-1000	3/4"	Bi-modal PE-RT Tube 1000' Coil Natural	1000'	911.50	1		
	500-34-1000B	3/4"	Bi-modal PE-RT Tube 1000' Coil Blue	1000'	911.50	1		
	500-34-1000R	3/4"	Bi-modal PE-RT Tube 1000' Coil Red	1000'	911.50	1		

HyperPure™ 1" PE-RT Tubing		NEW	Part No.	Size	Configuration	Length	List Price	Pack
	500-10-10	1"	Bi-modal PE-RT Tube 10' Stick Natural	10'	18.80	15		
	500-10-10B	1"	Bi-modal PE-RT Tube 10' Stick Blue	10'	18.80	15		
	500-10-10R	1"	Bi-modal PE-RT Tube 10' Stick Red	10'	18.80	15		
	500-10-20	1"	Bi-modal PE-RT Tube 20' Stick Natural	20'	37.60	15		
	500-10-20B	1"	Bi-modal PE-RT Tube 20' Stick Blue	20'	37.60	15		
	500-10-20R	1"	Bi-modal PE-RT Tube 20' Stick Red	20'	37.60	15		
	500-10-100	1"	Bi-modal PE-RT Tube 100' Coil Natural	100'	188.00	1		
	500-10-100B	1"	Bi-modal PE-RT Tube 100' Coil Blue	100'	188.00	1		
	500-10-100R	1"	Bi-modal PE-RT Tube 100' Coil Red	100'	188.00	1		
	500-10-300	1"	Bi-modal PE-RT Tube 300' Coil Natural	300'	564.00	1		
	500-10-300B	1"	Bi-modal PE-RT Tube 300' Coil Blue	300'	564.00	1		
	500-10-300R	1"	Bi-modal PE-RT Tube 300' Coil Red	300'	564.00	1		
	500-10-500	1"	Bi-modal PE-RT Tube 500' Coil Natural	500'	940.00	1		
	500-10-500B	1"	Bi-modal PE-RT Tube 500' Coil Blue	500'	940.00	1		
	500-10-500R	1"	Bi-modal PE-RT Tube 500' Coil Red	500'	940.00	1		

HyperPure™ 1-1/4" PE-RT Tubing		NEW	Part No.	Size	Configuration	Length	List Price	Pack
	500-114-20	1-1/4"	Bi-modal PE-RT Tube 20' Stick Natural	20'	75.00	5		

HyperPure™ 1-1/2" PE-RT Tubing		NEW	Part No.	Size	Configuration	Length	List Price	Pack
	500-112-20	1-1/2"	Bi-modal PE-RT Tube 20' Stick Natural	20'	92.95	5		

HyperPure™ 2" PE-RT Tubing		NEW	Part No.	Size	Configuration	Length	List Price	Pack
	500-20-20	2"	Bi-modal PE-RT Tube 20' Stick Natural	20'	180.50	5		

Cinch Clamp Tool **NEW**



The Legend Cinch Clamp Tool is for use with stainless steel cinch clamps in combination with brass insert fittings, compliant to ASTM F 1807 or plastic insert fittings, compliant to ASTM F 2098. Use with ASTM F 2769 & F 876/877 flexible tubing (size ranges from 3/8" to 1"). Steel construction with plastic grips. Includes gauge for calibrating the tool.

Part No.	Size	Configuration	Length	List Price	Pack
508-260	3/8" to 1"	Stainless steel cinch clamp tool (ASTM F1807/2098)		198.92	1

One Hand Cinch Clamp Tool **NEW**



The Legend One Hand Cinch Clamp Tool is for use with stainless steel cinch clamps in combination with brass insert fittings, compliant to ASTM F 1807 or plastic insert fittings, compliant to ASTM F 2098. Use with ASTM F 2769 & F 876/877 flexible tubing (size ranges from 3/8" to 1"). Includes LED light to indicate cinch is complete. Battery for LED and gauge for calibrating the tool are included. Steel construction with plastic grips.

508-261	3/8" to 1"	One hand stainless steel cinch clamp tool w/ LED light (ASTM F 1807/2098)		277.75	1
---------	------------	---	--	--------	---

Crimp Tool Set **NEW**



The Legend Crimp Tool Set includes 3/8", 1/2", 3/4" & 1" adapters, go/no go gauge, open-end wrench and replacement screws. Packaged in plastic storage case. For use with copper crimp rings in combination with brass insert fittings, compliant to ASTM F 1807 or plastic insert fittings, compliant to ASTM F 2098. Use with ASTM F 2769 & F 876/877 flexible tubing (size ranges from 3/8" to 1"). Steel construction with plastic grips.

508-280	3/8" to 1"	Crimp tool set for copper crimp ring, includes go/no go gauge & case (ASTM F 1807/2098)		516.25	1
---------	------------	---	--	--------	---

508-255	3/8" to 1"	Go/no go gauge for 3/8" to 1" copper crimp rings		12.45	25
---------	------------	--	--	-------	----

Large Diameter Crimp Tool Set **NEW**



The Legend Large Diameter Crimp Tool Set with indicator light includes 1-1/4", 1-1/2", & 2" adapters, go/no go gauge, 22 mm deep well socket, allen wrench, batteries and replacement screws. Packaged in plastic storage case. For use with copper and crimp rings in combination with brass insert fittings, compliant to ASTM F 1807 or plastic insert fittings, compliant to ASTM F 2098. Use with ASTM F 2769 & F 876/877 flexible tubing (size ranges from 1 1/4" to 2"). Steel construction with plastic grips.

508-281	1-1/4" to 2"	Large crimp tool set for copper crimp ring includes adapters, go/no go gauge & case (ASTM F 1807/2098)		527.35	1
---------	--------------	--	--	--------	---

508-256	1-1/4" to 2"	Go/no go gauge for 1-1/4" to 2" copper crimp rings		18.72	1
---------	--------------	--	--	-------	---

Plastic Tube Cutter

Part No.	Size	Configuration	Length	List Price	Pack
----------	------	---------------	--------	------------	------

Tube Cutter with one replacement blade cuts up to 2" plastic tubing. For PE-RT, PEX, CPVC and PVC.



800-250		Tube Cutter - PE-RT & PEX up to 2"		30.00	1
800-252		Replacement Blade for Tube Cutter		15.00	1
800-251		Ratchet Tube Cutter - CPVC and PVC up to 1-1/2"		70.00	1
800-253		Replacement Blade for Ratchet Tube Cutter		20.00	1

Tube Bend Support, Plastic

NEW

Durable plastic bend support with rail tab for securing to studs & joists when routing flexible plastic tubing in plumbing installations for 1/2", 3/4" and 1" sizes.



509-003	1/2"	Plastic Bend Support with Nail Tab		1.24	
509-004	3/4"	Plastic Bend Support with Nail Tab		3.03	
509-005	1"	Plastic Bend Support with Nail Tab		5.53	

Tube Bend Support, Metal

NEW

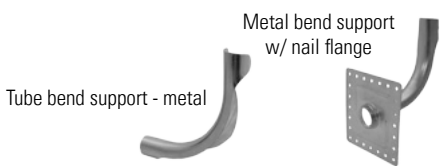

509-013	1/2"	Metal Bend Support		1.93	
509-014	3/4"	Metal Bend Support		2.89	
509-023	1/2"	Metal Bend Support with Nail Flange		3.25	

Tube Talon Fastener

Plastic talon hook with nail included secures tubing to wooden surfaces. Ideal for neatly routing and attaching flexible plastic tubing to floor joists and wall studs. For CTS 1/2", 3/4" and 1". Sold in bags of 100.



800-373	1/2"	Tube Talon		14.00	100
800-374	3/4"	Tube Talon		18.00	100
800-375	1"	Tube Talon		27.00	100

Tube Isolation Clamp

Plastic tube fastener for isolating flexible plastic tube as it passes through building floor joists and wall studs. Protects tubing from sharp or hard surfaces, ideal for plumbing and hydronic piping. Includes two pre-drilled screw holes, fits CTS 1/2", 3/4" and 1". Sold in bags of 100.



800-513	1/2"	Tube Isolation Clamp		18.00	100
800-514	3/4"	Tube Isolation Clamp		20.00	100
800-515	1"	Tube Isolation Clamp		32.00	100

Standard Tube Clamp

Plastic tube fastener for securing flexible plastic tube to solid surfaces, floor joists and wall studs. Protects and keeps tubing straight when routing in plumbing and hydronic piping. Includes two pre-drilled screw holes, fits CTS 1/2", 3/4" and 1". Sold in bags of 100.

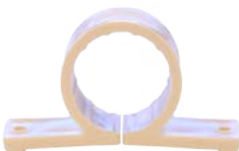

800-523	1/2"	Standard Tube Clamp		18.00	100
800-524	3/4"	Standard Tube Clamp		20.00	100
800-525	1"	Standard Tube Clamp		27.00	100

INDEX BY PART NUMBER

101-000.....	21	101-045NL.....	10	101-095.....	86	101-227.....	14	101-420NL.....	12
101-001.....	21	101-046.....	10	101-096.....	17	101-227NL.....	14	101-421.....	12
101-003.....	18	101-046NL.....	10	101-096.....	86	101-228.....	14	101-421NL.....	12
101-003NL.....	18	101-047.....	10	101-101.....	10	101-228NL.....	14	101-423.....	13
101-004.....	18	101-047NL.....	10	101-101NL.....	10	101-229.....	14	101-423NL.....	13
101-004NL.....	18	101-048.....	10	101-102.....	10	101-230.....	14	101-424.....	13
101-005.....	18	101-048NL.....	10	101-102NL.....	10	101-233.....	14	101-424NL.....	13
101-005NL.....	18	101-053.....	16	101-109.....	10	101-233NL.....	14	101-425.....	13
101-006.....	18	101-053NL.....	16	101-109NL.....	10	101-234.....	14	101-425NL.....	13
101-006NL.....	18	101-054.....	16	101-110.....	10	101-234NL.....	14	101-426.....	13
101-007.....	18	101-054NL.....	16	101-110NL.....	10	101-235.....	14	101-426NL.....	13
101-007NL.....	18	101-055.....	16	101-111.....	10	101-235NL.....	14	101-427.....	13
101-008.....	18	101-055NL.....	16	101-111NL.....	10	101-236.....	14	101-427NL.....	13
101-008NL.....	18	101-056.....	16	101-149.....	87	101-236NL.....	14	101-428.....	13
101-009.....	18	101-056NL.....	16	101-149NL.....	87	101-237.....	14	101-428NL.....	13
101-009NL.....	18	101-057.....	16	101-150.....	86	101-237NL.....	14	101-429.....	13
101-010.....	18	101-057NL.....	16	101-150NL.....	86	101-238.....	14	101-429NL.....	13
101-010NL.....	18	101-058.....	16	101-151.....	87	101-238NL.....	14	101-430.....	13
101-011.....	18	101-058NL.....	16	101-151NL.....	87	101-274.....	17	101-430NL.....	13
101-011NL.....	18	101-061.....	11	101-152.....	87	101-274.....	86	101-431.....	13
101-013.....	11	101-061NL.....	11	101-152NL.....	87	101-275.....	17	101-431NL.....	13
101-013NL.....	11	101-062.....	11	101-153.....	87	101-275.....	86	101-433NL.....	16
101-014.....	11	101-062NL.....	11	101-153NL.....	87	101-276.....	17	101-434NL.....	16
101-014NL.....	11	101-063.....	11	101-154.....	87	101-276.....	86	101-435NL.....	16
101-015.....	11	101-063NL.....	11	101-154NL.....	87	101-284.....	18	101-441.....	17
101-015NL.....	11	101-064.....	11	101-155.....	87	101-285.....	18	101-442.....	17
101-016.....	11	101-064NL.....	11	101-155NL.....	87	101-286.....	18	101-443.....	17
101-016NL.....	11	101-065.....	11	101-156.....	86	101-294.....	17	101-444.....	17
101-017.....	11	101-065NL.....	11	101-156NL.....	86	101-294.....	86	101-445.....	17
101-017NL.....	11	101-066.....	11	101-157.....	87	101-295.....	17	101-446.....	17
101-018.....	11	101-066NL.....	11	101-157NL.....	87	101-295.....	86	101-447.....	17
101-018NL.....	11	101-067.....	11	101-158.....	87	101-296.....	17	101-448.....	17
101-019.....	11	101-067NL.....	11	101-158NL.....	87	101-296.....	86	101-448.....	17
101-020.....	11	101-068.....	12	101-159.....	87	101-300.....	10	101-453NL.....	16
101-021.....	11	101-068NL.....	12	101-159NL.....	87	101-300NL.....	10	101-454NL.....	16
101-023.....	10	101-069.....	12	101-160.....	87	101-323NL.....	13	101-455NL.....	16
101-023NL.....	10	101-069NL.....	12	101-160NL.....	87	101-324NL.....	13	101-463NL.....	20
101-024.....	10	101-070.....	12	101-174.....	18	101-324NL.....	13	101-464NL.....	20
101-024NL.....	10	101-070NL.....	12	101-174.....	86	101-325NL.....	13	101-465NL.....	20
101-025.....	10	101-074.....	17	101-175.....	18	101-326NL.....	13	101-503.....	14
101-025NL.....	10	101-074.....	86	101-175.....	86	101-327NL.....	13	101-503NL.....	14
101-026.....	10	101-075.....	17	101-175.....	86	101-328NL.....	13	101-504.....	14
101-026NL.....	10	101-075.....	86	101-176.....	18	101-333NL.....	13	101-504NL.....	14
101-027.....	10	101-075.....	86	101-176.....	86	101-334NL.....	13	101-505.....	14
101-027NL.....	10	101-076.....	17	101-194.....	18	101-335NL.....	13	101-505NL.....	14
101-028.....	10	101-076.....	86	101-194.....	86	101-336NL.....	13	101-513.....	14
101-028NL.....	10	101-082.....	12	101-195.....	18	101-337NL.....	13	101-513NL.....	14
101-033.....	11	101-082NL.....	12	101-195.....	86	101-338NL.....	13	101-514.....	14
101-033NL.....	11	101-083.....	12	101-196.....	18	101-411.....	12	101-514NL.....	14
101-034.....	11	101-083NL.....	12	101-196.....	86	101-411NL.....	12	101-515.....	14
101-034NL.....	11	101-084.....	12	101-209.....	10	101-412.....	12	101-515NL.....	14
101-035.....	11	101-084NL.....	12	101-209NL.....	10	101-412NL.....	12	101-520.....	21
101-035NL.....	11	101-085.....	12	101-210.....	10	101-413.....	12	101-520NL.....	21
101-036.....	11	101-085NL.....	12	101-210NL.....	10	101-413NL.....	12	101-521.....	21
101-036NL.....	11	101-086.....	12	101-211.....	10	101-414.....	12	101-521NL.....	21
101-037.....	11	101-086NL.....	12	101-221.....	13	101-414NL.....	12	101-522.....	21
101-037NL.....	11	101-087.....	12	101-221NL.....	13	101-415.....	12	101-522NL.....	21
101-038.....	11	101-087NL.....	12	101-222.....	13	101-415NL.....	12	101-523.....	21
101-038NL.....	11	101-088.....	12	101-222NL.....	13	101-416.....	12	101-523NL.....	21
101-039.....	11	101-088NL.....	12	101-223.....	13	101-416NL.....	12	101-524.....	21
101-040.....	11	101-089.....	12	101-223NL.....	13	101-417.....	12	101-524NL.....	21
101-043.....	10	101-089NL.....	12	101-224.....	13	101-417NL.....	12	101-525.....	21
101-043NL.....	10	101-090.....	12	101-224NL.....	13	101-418.....	12	101-525NL.....	21
101-044.....	10	101-090NL.....	12	101-225.....	13	101-418NL.....	12	101-530.....	21
101-044NL.....	10	101-094.....	17	101-225NL.....	13	101-419.....	12	101-530NL.....	21
101-045.....	10	101-094.....	86	101-226.....	14	101-419NL.....	12	101-531.....	21
		101-095.....	17	101-226NL.....	14	101-420.....	12	101-531NL.....	21

101-532.....21	101-623.....15	102-115.....25	103-105NL.....30	104-469.....29
101-532NL.....21	101-624.....15	102-118.....24	103-106.....30	104-470.....29
101-533.....21	101-625.....15	102-119.....25	103-106NL.....30	104-471.....29
101-533NL.....21	101-633.....16	102-120.....25	103-107.....30	104-473.....29
101-534.....21	101-633NL.....16	102-121.....25	103-107NL.....30	104-473NL.....29
101-534NL.....21	101-634.....16	102-122.....25	103-108.....30	104-474.....29
101-535.....21	101-634NL.....16	102-212.....25	103-108NL.....30	104-474NL.....29
101-535NL.....21	101-635.....16	102-213.....25	103-113.....30	104-475.....29
101-540.....21	101-635NL.....16	102-312.....25	103-114.....30	104-475NL.....29
101-540NL.....21	101-643NL.....16	102-313.....25	103-115.....30	104-476.....29
101-541.....21	101-644NL.....16	102-314.....25	103-116.....30	104-476NL.....29
101-541NL.....21	101-645NL.....16	102-413.....25	103-117.....30	104-477.....29
101-543NL.....20	101-653.....16	102-414.....25	103-118.....30	104-477NL.....29
101-544NL.....20	101-653NL.....16	102-513.....25	104-301.....27	104-478.....29
101-545NL.....20	101-654.....16	102-514.....25	104-302.....27	104-478NL.....29
101-546NL.....20	101-654NL.....16	102-515.....25	104-303.....27	104-501.....26
101-547NL.....20	101-655.....16	102-522.....25	104-303NL.....27	104-502.....26
101-548NL.....20	101-655NL.....16	102-523.....25	104-304.....27	104-503.....26
101-550NL.....21	101-684NL.....17	102-612.....25	104-304NL.....27	104-504.....26
101-551NL.....21	101-703NL.....15	102-613.....25	104-305.....27	104-505.....26
101-563NL.....20	101-704NL.....15	102-614.....25	104-305NL.....27	104-506.....26
101-564NL.....20	101-705NL.....15	102-615.....25	104-306.....27	104-507.....26
101-565NL.....20	101-706NL.....15	102-616.....25	104-306NL.....27	104-508.....26
101-570.....17	101-707NL.....15	102-617.....25	104-307.....27	104-509.....26
101-573NL.....19	101-708NL.....15	102-618.....25	104-307NL.....27	104-510.....26
101-574NL.....19	101-723.....15	102-713.....25	104-308.....27	104-511.....26
101-576NL.....20	101-724.....15	102-714.....25	104-308NL.....27	104-603.....27
101-577NL.....20	101-725.....15	102-803.....69	104-309.....27	104-604.....27
101-578NL.....20	101-726.....15	102-804.....69	104-310.....27	104-605.....27
101-579NL.....19	101-727.....15	102-813.....69	104-311.....27	104-606.....27
101-580NL.....19	101-728.....15	102-814.....69	104-403.....28	104-607.....27
101-581NL.....19	101-733.....15	102-820.....69	104-403NL.....28	104-608.....27
101-582NL.....19	101-734.....15	102-821.....69	104-404.....28	104-609.....27
101-583NL.....19	101-735.....15	102-823.....69	104-404NL.....28	104-610.....27
101-584NL.....19	101-736.....15	102-824.....69	104-405.....28	104-611.....27
101-585NL.....19	101-737.....15	102-825.....69	104-405NL.....28	104-613.....26
101-586NL.....19	101-738.....15	102-827.....69	104-406.....28	104-614.....26
101-587NL.....19	101-931.....22	102-830.....69	104-406NL.....28	104-615.....26
101-588NL.....19	101-932.....22	102-833.....69	104-407.....28	104-616.....26
101-589NL.....19	101-933.....22	102-834.....69	104-407NL.....28	104-617.....26
101-590NL.....20	101-950.....22	102-836.....24	104-408.....28	104-618.....26
101-591NL.....20	101-951.....22	102-837.....24	104-408NL.....28	104-653.....26
101-592NL.....20	101-952.....22	102-840.....69	104-409.....28	104-654.....26
101-593NL.....19	101-953.....22	102-841.....69	104-410.....28	104-655.....26
101-594NL.....19	101-954.....22	102-843.....69	104-414.....27	104-656.....26
101-595NL.....19	101-955.....22	102-844.....69	104-415.....27	104-657.....26
101-596NL.....20	101-956.....22	102-850.....69	104-416.....27	104-658.....26
101-597NL.....20	101-957.....22	102-851.....69	104-417.....27	104-663.....26
101-598NL.....20	101-958.....22	102-852.....69	104-451.....29	104-664.....26
101-600NL.....20	101-959.....22	102-853.....69	104-452.....29	104-665.....26
101-601NL.....20	101-960.....22	102-863.....69	104-453.....29	104-666.....26
101-602NL.....20	101-961.....22	102-864.....69	104-454.....29	104-667.....26
101-603NL.....14	101-962.....22	102-873.....69	104-455.....29	104-668.....26
101-604NL.....14	101-963.....22	102-874.....69	104-456.....29	104-703.....28
101-605NL.....14	101-964.....22	102-883.....69	104-463.....29	104-703NL.....28
101-606NL.....14	101-965.....22	102-884.....70	104-463NL.....29	104-704.....28
101-607NL.....14	101-982.....22	102-893.....70	104-464.....29	104-704NL.....28
101-608NL.....14	101-983.....22	102-894.....70	104-464NL.....29	104-705.....28
101-611.....15	101-984.....22	102-903.....25	104-465.....29	104-705NL.....28
101-612.....15	101-985.....22	102-904.....25	104-465NL.....29	104-706.....28
101-613.....15	102-102.....24	102-905.....25	104-466.....29	104-706NL.....28
101-614.....15	102-103.....24	103-103.....30	104-466NL.....29	104-707.....28
101-615.....15	102-104.....24	103-103NL.....30	104-467.....29	104-707NL.....28
101-616.....15	102-112.....24	103-104.....30	104-467NL.....29	104-708.....28
101-617.....15	102-113.....24	103-104NL.....30	104-468.....29	104-708NL.....28
101-618.....15	102-114.....25	103-105.....30	104-468NL.....29	104-709.....28

INDEX BY PART NUMBER

104-709NL.....28	105-210NL.....31	105-503.....34	105-617.....37	107-154.....46
104-710.....28	105-303.....32	105-503NL.....34	105-617.....62	107-154NL.....46
104-710NL.....28	105-303NL.....32	105-504.....34	105-703.....35	107-155.....46
104-711.....28	105-304.....32	105-504NL.....34	105-703NL.....35	107-155NL.....46
104-711NL.....28	105-304NL.....32	105-505.....34	105-704.....35	107-157NL.....46
104-723.....28	105-305.....32	105-505NL.....34	105-704NL.....35	107-159.....46
104-723NL.....28	105-305NL.....32	105-506.....34	105-705.....35	107-159NL.....46
104-724.....28	105-306.....32	105-506NL.....34	105-705NL.....35	107-162.....43
104-724NL.....28	105-306NL.....32	105-507.....34	105-706.....35	107-162NL.....43
104-725.....28	105-307.....32	105-507NL.....34	105-706NL.....35	107-163.....43
104-725NL.....28	105-307NL.....32	105-508.....35	105-707.....35	107-163NL.....43
104-726.....28	105-308.....32	105-508NL.....35	105-707NL.....35	107-164.....47
104-726NL.....28	105-308NL.....32	105-509.....35	105-708.....35	107-164NL.....47
104-727.....28	105-403.....32	105-509NL.....35	105-708NL.....35	107-165.....47
104-727NL.....28	105-403NL.....32	105-510.....35	105-709.....36	107-165NL.....47
104-728.....28	105-404.....32	105-510NL.....35	105-709NL.....36	107-167.....43
104-728NL.....28	105-404NL.....32	105-513.....35	105-710.....36	107-167NL.....43
104-733.....29	105-405.....32	105-513NL.....35	105-710NL.....36	107-168.....43
104-734.....29	105-405NL.....32	105-514.....35	105-713.....37	107-168NL.....43
104-735.....29	105-406.....32	105-514NL.....35	105-714.....37	107-169.....43
104-736.....29	105-406NL.....32	105-515.....35	105-715.....37	107-169NL.....43
104-737.....29	105-407.....32	105-515NL.....35	105-716.....37	107-171.....47
104-738.....29	105-407NL.....32	105-516.....35	105-717.....37	107-171NL.....47
105-003NL.....31	105-408.....32	105-516NL.....35	105-718.....37	107-173.....47
105-004NL.....31	105-408NL.....32	105-517.....35	105-719.....37	107-173NL.....47
105-005NL.....31	105-423NL.....33	105-517NL.....35	105-720.....37	107-174.....49
105-006NL.....31	105-424NL.....33	105-518.....35	105-723.....37	107-174NL.....49
105-007NL.....31	105-425NL.....33	105-518NL.....35	105-724.....37	107-175.....49
105-008NL.....31	105-426NL.....33	105-519.....35	105-725.....37	107-175NL.....49
105-101.....30	105-427NL.....33	105-519NL.....35	105-726.....37	107-183.....49
105-101NL.....30	105-428NL.....33	105-520.....35	105-727.....37	107-183NL.....49
105-102.....30	105-430NL.....33	105-520NL.....35	105-728.....37	107-184.....49
105-102NL.....30	105-431NL.....33	105-521.....37	105-733.....36	107-184NL.....49
105-103.....30	105-443.....32	105-522.....37	105-734.....36	107-185.....49
105-103NL.....30	105-443NL.....32	105-523.....37	105-735.....36	107-185NL.....49
105-104.....30	105-444.....32	105-524.....37	105-736.....36	107-187.....49
105-104NL.....30	105-444NL.....32	105-525.....37	105-737.....36	107-187NL.....49
105-105.....30	105-445.....32	105-526.....37	105-738.....36	107-188.....49
105-105NL.....30	105-445NL.....32	105-527.....37	107-103NL.....45	107-188NL.....49
105-106.....31	105-446.....32	105-528.....37	107-104NL.....45	107-189.....49
105-106NL.....31	105-446NL.....32	105-529.....37	107-106.....45	107-189NL.....49
105-107.....31	105-447.....32	105-530.....37	107-107.....45	107-192.....50
105-107NL.....31	105-447NL.....32	105-533.....36	107-110NL.....45	107-192NL.....50
105-108.....31	105-448.....32	105-534.....36	107-110NL.....45	107-193.....68
105-108NL.....31	105-448NL.....32	105-535.....36	107-111NL.....45	107-194.....68
105-109.....31	105-463.....33	105-536.....36	107-111NL.....45	107-194NL.....68
105-109NL.....31	105-463NL.....33	105-537.....36	107-113NL.....45	107-195.....68
105-110.....31	105-464.....33	105-538.....36	107-114NL.....45	107-195NL.....68
105-110NL.....31	105-464NL.....33	105-543.....36	107-116NL.....45	107-196.....68
105-111.....31	105-465.....33	105-544.....36	107-117NL.....45	107-198.....68
105-111NL.....31	105-465NL.....33	105-545.....36	107-118NL.....45	107-199.....68
105-203.....31	105-466.....33	105-546.....36	107-119NL.....45	107-203.....47
105-203NL.....31	105-466NL.....33	105-547.....36	107-123NL.....46	107-203NL.....47
105-204.....31	105-467.....33	105-548.....36	107-124NL.....46	107-204.....47
105-204NL.....31	105-467NL.....33	105-611.....37	107-130NL.....46	107-204NL.....47
105-205.....31	105-468.....33	105-611.....62	107-131NL.....46	107-213.....47
105-205NL.....31	105-468NL.....33	105-612.....37	107-133NL.....46	107-213NL.....47
105-206.....31	105-474NL.....34	105-612.....62	107-134NL.....46	107-214.....47
105-206NL.....31	105-475NL.....34	105-613.....37	107-143.....46	107-214NL.....47
105-207.....31	105-476NL.....34	105-613.....62	107-143NL.....46	107-223.....47
105-207NL.....31	105-477NL.....34	105-614.....37	107-144.....46	107-223NL.....47
105-208.....31	105-478NL.....34	105-614.....62	107-144NL.....46	107-243.....50
105-208NL.....31	105-501.....34	105-615.....37	107-146.....46	107-243NL.....50
105-209.....31	105-501NL.....34	105-615.....62	107-146NL.....46	107-244.....50
105-209NL.....31	105-502.....34	105-616.....37	107-148.....46	107-244NL.....50
105-210.....31	105-502NL.....34	105-616.....62	107-148NL.....46	107-245.....50

107-245NL.....	50	107-452.....	44	108-037.....	40	108-158NL.....	38	110-245.....	84
107-246.....	50	107-452.....	44	108-037NL.....	40	108-159A.....	38	110-246.....	84
107-246NL.....	50	107-464.....	44	108-038.....	40	108-159NL.....	38	110-247.....	84
107-247.....	73	107-465.....	44	108-038NL.....	40	108-160A.....	38	110-301.....	88
107-247NL.....	73	107-474.....	44	108-101.....	42	108-160NL.....	38	110-302.....	88
107-253.....	45	107-475.....	44	108-101NL.....	42	108-162.....	39	110-303.....	88
107-253NL.....	45	107-543.....	42	108-102.....	42	108-166A.....	38	110-304.....	88
107-255.....	45	107-543NL.....	42	108-102NL.....	42	108-167A.....	38	110-305.....	88
107-255NL.....	45	107-544.....	42	108-103.....	42	108-168A.....	38	110-321.....	88
107-256.....	45	107-544NL.....	42	108-103NL.....	42	108-169A.....	38	110-322.....	88
107-256NL.....	45	107-554.....	42	108-104.....	42	108-173A.....	38	110-323.....	88
107-257.....	45	107-554NL.....	42	108-104NL.....	42	108-174A.....	38	110-324.....	88
107-257NL.....	45	107-555.....	42	108-105.....	42	108-175A.....	38	110-325.....	88
107-259.....	45	107-555NL.....	42	108-105NL.....	42	108-550.....	40	110-331.....	88
107-259NL.....	45	107-567.....	43	108-106.....	42	108-550NL.....	40	110-332.....	88
107-263.....	48	107-567NL.....	43	108-106NL.....	42	108-903.....	40	110-333.....	88
107-263NL.....	48	107-568.....	43	108-113.....	42	108-904A.....	39	110-337.....	89
107-264.....	48	107-568NL.....	43	108-113NL.....	42	108-906A.....	39	110-338.....	89
107-264NL.....	48	107-574.....	42	108-114.....	42	108-908A.....	39	110-340.....	89
107-265.....	48	107-574NL.....	42	108-114NL.....	42	108-910A.....	39	110-345.....	89
107-265NL.....	48	107-575.....	42	108-115.....	42	108-912A.....	39	110-346.....	89
107-267.....	48	107-575NL.....	42	108-115NL.....	42	108-914A.....	39	110-347.....	89
107-267NL.....	48	107-584.....	42	108-120.....	39	110-103.....	84	110-348.....	89
107-268.....	48	107-584NL.....	42	108-121.....	41	110-104.....	84	110-350.....	88
107-268NL.....	48	107-585.....	43	108-121NL.....	41	110-105.....	84	110-351.....	88
107-270.....	48	107-585NL.....	43	108-122.....	41	110-106.....	84	110-404.....	85
107-270NL.....	48	108-003A.....	38	108-122NL.....	41	110-107.....	84	110-405.....	85
107-271.....	48	108-003NL.....	38	108-123.....	41	110-108.....	84	110-406.....	85
107-271NL.....	48	108-004A.....	38	108-123NL.....	41	110-113.....	84	111-033NL.....	70
107-275.....	48	108-004NL.....	38	108-124.....	41	110-114.....	84	111-034NL.....	70
107-275NL.....	48	108-005A.....	38	108-124NL.....	41	110-115.....	84	111-035NL.....	70
107-277.....	48	108-005NL.....	38	108-125.....	41	110-116.....	84	111-103NL.....	71
107-277NL.....	48	108-006A.....	38	108-125NL.....	41	110-117.....	84	111-104NL.....	71
107-316NL.....	46	108-006NL.....	38	108-126.....	41	110-123.....	84	111-105NL.....	71
107-317NL.....	46	108-021.....	39	108-126NL.....	41	110-124.....	84	111-106NL.....	71
107-327.....	46	108-021NL.....	39	108-133.....	41	110-125.....	85	111-113NL.....	71
107-327NL.....	46	108-022.....	39	108-133NL.....	41	110-126.....	85	111-114NL.....	71
107-328.....	46	108-022NL.....	39	108-134.....	41	110-133.....	84	111-115NL.....	71
107-328NL.....	46	108-023.....	39	108-134NL.....	41	110-134.....	84	111-116NL.....	71
107-347.....	49	108-023NL.....	39	108-135.....	41	110-135.....	84	111-123NL.....	71
107-347NL.....	49	108-024.....	39	108-135NL.....	41	110-136.....	84	111-124NL.....	71
107-403.....	49	108-024NL.....	39	108-138.....	41	110-137.....	84	111-125NL.....	71
107-403NL.....	49	108-025.....	39	108-139.....	41	110-143.....	84	111-133.....	71
107-404.....	49	108-025NL.....	39	108-141.....	41	110-145.....	85	111-133NL.....	71
107-404NL.....	49	108-026.....	39	108-141NL.....	41	110-146.....	85	111-134.....	71
107-407.....	49	108-026NL.....	39	108-142.....	41	110-147.....	84	111-134NL.....	71
107-407NL.....	49	108-027.....	39	108-142NL.....	41	110-148.....	84	111-136.....	71
107-408.....	49	108-027NL.....	39	108-143.....	41	110-149.....	84	111-137.....	71
107-408NL.....	49	108-028.....	39	108-143NL.....	41	110-150.....	84	111-137NL.....	71
107-410.....	49	108-028NL.....	39	108-144.....	41	110-151.....	84	111-152.....	73
107-413.....	49	108-029.....	39	108-144NL.....	41	110-153.....	85	111-154.....	73
107-413NL.....	49	108-029NL.....	39	108-145.....	41	110-154.....	85	111-158.....	73
107-414.....	49	108-030.....	39	108-145NL.....	41	110-155.....	85	111-205.....	87
107-414NL.....	49	108-030NL.....	39	108-146.....	41	110-163.....	85	111-206.....	87
107-417.....	50	108-031.....	39	108-146NL.....	41	110-164.....	85	111-222.....	72
107-417NL.....	50	108-031NL.....	39	108-153A.....	38	110-165.....	85	111-223.....	72
107-418.....	50	108-032.....	39	108-153NL.....	38	110-166.....	85	111-224.....	72
107-418NL.....	50	108-032NL.....	39	108-154A.....	38	110-168.....	85	111-235.....	72
107-423.....	47	108-033.....	40	108-154NL.....	38	110-169.....	85	111-236.....	72
107-423NL.....	47	108-033NL.....	40	108-155A.....	38	110-170.....	85	111-237.....	72
107-424.....	47	108-034.....	40	108-155NL.....	38	110-213.....	85	111-238.....	72
107-424NL.....	47	108-034NL.....	40	108-156A.....	38	110-214.....	85	111-243.....	72
107-441.....	44	108-035.....	40	108-156NL.....	38	110-217.....	85	111-244.....	72
107-442.....	44	108-035NL.....	40	108-157A.....	38	110-218.....	85	111-247.....	73
107-451.....	44	108-036.....	40	108-157NL.....	38	110-243.....	84	111-248.....	73
107-451.....	44	108-036NL.....	40	108-158A.....	38	110-244.....	84	111-253.....	72

INDEX BY PART NUMBER

111-254.....	72	113-206.....	24	114-146NL.....	52	114-913NL.....	50	116-381.....	66
111-255.....	72	113-207.....	24	114-153NL.....	52	114-914NL.....	50	116-382.....	66
111-256.....	72	113-208.....	24	114-154NL.....	52	115-103.....	68	116-383.....	66
111-263.....	73	113-211.....	24	114-163NL.....	52	115-103NL.....	68	116-384.....	66
111-264.....	73	113-212.....	24	114-200NL.....	52	115-104.....	68	116-385.....	66
111-265.....	73	113-213.....	24	114-201NL.....	52	115-104NL.....	68	116-401.....	63
111-266.....	73	113-214.....	24	114-202NL.....	52	115-105.....	68	116-402.....	63
111-273.....	73	113-215.....	24	114-203NL.....	52	115-105NL.....	68	116-403.....	63
111-274.....	73	113-216.....	24	114-204NL.....	52	115-113.....	68	116-404.....	63
111-275.....	73	113-217.....	24	114-207NL.....	52	115-114.....	68	116-405.....	63
111-276.....	73	113-218.....	24	114-209NL.....	53	115-117.....	68	116-406.....	63
111-302NL.....	72	113-221.....	24	114-213NL.....	53	115-118.....	68	116-407.....	63
111-303NL.....	72	113-222.....	24	114-215NL.....	53	115-153.....	71	116-408.....	63
111-304NL.....	72	113-223.....	24	114-231NL.....	53	115-154.....	71	116-409.....	63
111-305NL.....	72	113-224.....	24	114-233NL.....	53	115-155.....	71	116-411.....	64
111-323NL.....	70	113-225.....	24	114-234NL.....	53	116-101.....	61	116-412.....	64
111-324NL.....	70	113-226.....	24	114-236NL.....	53	116-102.....	61	116-413.....	64
111-325NL.....	70	113-227.....	24	114-253NL.....	53	116-103.....	61	116-414.....	64
111-333NL.....	70	113-228.....	24	114-254NL.....	53	116-104.....	61	116-415.....	64
111-334NL.....	70	113-301.....	22	114-256NL.....	53	116-105.....	61	116-416.....	64
111-335NL.....	70	113-311.....	22	114-304NL.....	52	116-106.....	61	116-417.....	64
112-033NL.....	70	113-403.....	26	114-402NL.....	53	116-107.....	61	116-418.....	64
112-034NL.....	70	113-404.....	26	114-403NL.....	53	116-108.....	61	116-419.....	64
112-035NL.....	70	113-405.....	26	114-404NL.....	53	116-109.....	61	116-421.....	63
116-234.....	62	113-406.....	26	114-406NL.....	53	116-121.....	61	116-422.....	63
113-101.....	23	113-407.....	26	114-413NL.....	53	116-122.....	61	116-423.....	63
113-102.....	23	113-408.....	26	114-423NL.....	53	116-123.....	61	116-424.....	63
113-103.....	23	113-433.....	34	114-424NL.....	53	116-124.....	61	116-425.....	63
113-104.....	23	113-434.....	34	114-513NL.....	53	116-125.....	61	116-426.....	63
113-105.....	23	113-435.....	34	114-602NL.....	50	116-126.....	61	116-427.....	63
113-106.....	23	113-436.....	34	114-603NL.....	50	116-127.....	61	116-428.....	63
113-107.....	23	113-437.....	34	114-604NL.....	50	116-128.....	61	116-429.....	63
113-108.....	23	113-438.....	34	114-605NL.....	51	116-129.....	61	116-431.....	64
113-109.....	23	113-455.....	34	114-606NL.....	50	116-201.....	61	116-432.....	64
113-110.....	23	113-456.....	34	114-607NL.....	50	116-202.....	61	116-433.....	64
113-111.....	23	113-465.....	34	114-609NL.....	50	116-203.....	61	116-434.....	64
113-120.....	23	113-466.....	34	114-613NL.....	50	116-204.....	61	116-435.....	64
113-121.....	23	113-473.....	30	114-614NL.....	51	116-205.....	61	116-436.....	64
113-122.....	23	113-474.....	30	114-615NL.....	51	116-206.....	61	116-437.....	64
113-123.....	23	113-475.....	30	114-624NL.....	51	116-207.....	61	116-438.....	64
113-124.....	23	113-476.....	30	114-653NL.....	51	116-221.....	62	116-439.....	64
113-125.....	23	113-477.....	30	114-654NL.....	51	116-222.....	62	116-441.....	63
113-126.....	23	113-478.....	30	114-702NL.....	51	116-223.....	62	116-442.....	63
113-127.....	23	113-493.....	38	114-703NL.....	51	116-224.....	62	116-443.....	63
113-128.....	23	113-494.....	38	114-704NL.....	51	116-225.....	62	116-444.....	63
113-141.....	23	113-495.....	38	114-705NL.....	51	116-226.....	62	116-445.....	63
113-142.....	23	113-496.....	38	114-706NL.....	51	116-227.....	62	116-446.....	63
113-143.....	23	113-497.....	38	114-707NL.....	51	116-228.....	62	116-447.....	63
113-144.....	23	113-498.....	38	114-709NL.....	51	116-229.....	62	116-448.....	63
113-145.....	23	114-101NL.....	52	114-710NL.....	51	116-231.....	62	116-449.....	63
113-146.....	23	114-102NL.....	52	114-713NL.....	51	116-232.....	62	116-461.....	63
113-147.....	23	114-103NL.....	52	114-714NL.....	51	116-233.....	62	116-462.....	63
113-148.....	23	114-104NL.....	52	114-715NL.....	51	116-235.....	62	116-463.....	63
113-161.....	23	114-107NL.....	52	114-724NL.....	51	116-235.....	62	116-464.....	63
113-162.....	23	114-109NL.....	52	114-753NL.....	51	116-237.....	62	116-465.....	63
113-163.....	23	114-113NL.....	52	114-754NL.....	51	116-238.....	62	116-466.....	63
113-164.....	23	114-115NL.....	52	114-801NL.....	51	116-239.....	62	116-467.....	63
113-165.....	23	114-116NL.....	52	114-802NL.....	51	116-241.....	62	116-468.....	63
113-166.....	23	114-123NL.....	52	114-803NL.....	51	116-242.....	62	116-469.....	63
113-167.....	23	114-124NL.....	52	114-804NL.....	51	116-243.....	62	116-601.....	64
113-168.....	23	114-126NL.....	52	114-805NL.....	51	116-244.....	62	116-602.....	64
113-201.....	24	114-133NL.....	52	114-806NL.....	51	116-245.....	62	116-603.....	64
113-202.....	24	114-134NL.....	52	114-823NL.....	51	116-246.....	62	116-604.....	64
113-203.....	24	114-136NL.....	52	114-824NL.....	51	116-247.....	62	116-605.....	64
113-204.....	24	114-143NL.....	52	114-903NL.....	50	116-248.....	62	116-606.....	64
113-205.....	24	114-144NL.....	52	114-904NL.....	50	116-249.....	62	116-607.....	64

116-608.....64	201-234.....54	201-425.....55	202-546.....59	204-235.....61
116-609.....64	201-235.....54	201-426.....55	202-553.....59	301-103NL.....74
116-611.....65	201-236.....54	201-427.....55	202-554.....59	301-104NL.....74
116-612.....65	201-237.....54	201-428.....55	202-555.....60	301-105NL.....74
116-613.....65	201-238.....54	201-433.....55	202-556.....60	301-106NL.....74
116-614.....65	201-239.....54	201-434.....55	202-563.....60	301-107NL.....74
116-615.....65	201-240.....54	201-435.....55	202-564.....60	301-108NL.....74
116-616.....65	201-241.....54	201-436.....55	202-573.....60	301-119NL.....74
116-617.....65	201-243.....55	201-437.....55	202-574.....60	301-120NL.....74
116-618.....65	201-244.....55	201-438.....55	203-103.....57	301-121NL.....74
116-619.....65	201-245.....55	201-439.....55	203-104.....57	301-123NL.....74
116-621.....65	201-246.....55	201-440.....55	203-105.....57	301-125NL.....74
116-622.....65	201-247.....55	201-441.....55	203-106.....57	301-203NL.....74
116-623.....65	201-248.....55	201-443.....56	203-107.....57	301-204NL.....74
116-624.....65	201-253.....55	201-444.....56	203-108.....57	301-205NL.....74
116-625.....65	201-254.....55	201-445.....56	203-203.....57	301-303.....74
116-626.....65	201-255.....55	201-446.....56	203-204.....57	301-304.....74
116-627.....65	201-256.....55	201-447.....56	203-205.....57	301-305.....74
116-628.....65	201-257.....55	201-448.....56	203-206.....57	301-306.....74
116-629.....65	201-258.....55	201-453.....56	203-207.....57	301-307.....74
116-631.....65	201-263.....54	201-454.....56	203-208.....57	301-308.....74
116-632.....65	201-264.....54	201-455.....56	203-227.....58	301-323NL.....75
116-633.....65	201-265.....54	201-456.....56	203-228.....58	301-324NL.....75
116-634.....65	201-266.....54	201-457.....56	203-230.....58	301-325NL.....75
116-635.....65	201-268.....54	201-458.....56	203-237.....58	301-333.....75
116-636.....65	201-269.....54	201-467.....57	203-238.....58	301-334.....75
116-637.....65	201-270.....54	202-251.....58	203-247.....58	301-335.....75
116-638.....65	201-271.....54	202-252.....58	203-248.....58	301-336.....75
116-639.....65	201-272.....54	202-253.....58	203-257.....58	301-337.....75
116-641.....64	201-273.....57	202-254.....58	203-258.....58	301-338.....75
116-642.....64	201-274.....57	202-255.....58	204-103.....76	301-403.....75
116-643.....64	201-275.....57	202-262.....58	204-104.....76	301-404.....75
116-644.....64	201-277.....57	202-263.....58	204-105.....76	301-405.....75
116-645.....64	201-278.....57	202-264.....58	204-106.....76	301-406.....75
116-646.....64	201-284.....57	202-273.....58	204-107.....76	301-407.....75
116-647.....64	201-285.....57	202-274.....58	204-108.....76	301-408.....75
116-648.....64	201-287.....57	202-283.....58	204-109.....76	301-409.....75
116-649.....64	201-288.....57	202-284.....58	204-110.....76	301-410.....75
116-661.....65	201-293.....57	202-403*.....59	204-111.....76	301-411.....75
116-662.....65	201-294.....57	202-404*.....59	204-112.....76	301-421.....74
116-663.....65	201-295.....57	202-405*.....59	204-123.....76	301-433.....75
116-664.....65	201-297.....57	202-406.....59	204-124.....76	301-434.....75
116-665.....65	201-298.....57	202-407.....59	204-133.....60	301-435.....75
116-666.....65	201-303.....56	202-408.....59	204-134.....60	301-436.....75
116-667.....65	201-304.....56	202-413.....59	204-143.....77	301-437.....75
116-668.....65	201-305.....56	202-414.....59	204-144.....77	301-438.....75
116-669.....65	201-306.....56	202-415.....59	204-145.....77	301-439.....75
201-183.....55	201-307.....56	202-416.....59	204-146.....77	301-440.....75
201-184.....55	201-308.....56	202-417.....59	204-147.....77	301-441.....75
201-185.....55	201-309.....56	202-418.....59	204-148.....77	301-443.....75
201-186.....55	201-310.....56	202-423.....59	204-173.....60	301-444.....75
201-187.....55	201-311.....56	202-424.....59	204-174.....60	301-445.....75
201-188.....55	201-403.....56	202-425.....59	204-175.....60	301-446.....75
201-203.....54	201-404.....56	202-503.....59	204-176.....60	301-447.....75
201-204.....54	201-405.....56	202-504.....59	204-177.....60	301-448.....75
201-205.....54	201-406.....56	202-513.....59	204-178.....60	301-449.....75
201-206.....54	201-407.....56	202-514.....59	204-180.....60	301-450.....75
201-207.....54	201-408.....56	202-523.....59	204-193.....60	301-502.....74
201-208.....54	201-409.....56	202-524.....59	204-194.....60	301-503.....74
201-209.....54	201-410.....56	202-533.....59	204-195.....60	301-504.....74
201-210.....54	201-411.....56	202-534.....59	204-196.....60	301-505.....74
201-211.....54	201-417.....56	202-535.....59	204-197.....60	301-506.....74
201-229.....54	201-418.....56	202-536.....59	204-198.....60	301-507.....74
201-230.....54	201-419.....56	202-543.....59	204-214.....61	301-533.....74
201-231.....54	201-423.....55	202-544.....59	204-216.....61	301-534.....74
201-233.....54	201-424.....55	202-545.....59	204-234.....61	301-535.....74

INDEX BY PART NUMBER

301-536.....	74	302-262.....	79	302-403NL.....	80	322-201.....	83	500-10-10.....	153
301-537.....	74	302-262NL.....	79	302-404NL.....	80	322-233.....	83	500-10-100.....	153
301-538.....	74	302-263.....	79	302-405NL.....	80	322-234.....	83	500-10-100B.....	153
302-106.....	82	302-263NL.....	79	302-406NL.....	80	322-235.....	83	500-10-100R.....	153
302-107.....	82	302-264.....	79	302-407NL.....	80	322-510.....	82	500-10-10B.....	153
302-108.....	82	302-264NL.....	79	302-408NL.....	80	322-511.....	82	500-10-10R.....	153
302-116.....	82	302-273.....	78	302-413NL.....	80	322-521.....	82	500-10-20.....	153
302-117.....	82	302-273NL.....	78	302-414NL.....	80	322-523.....	82	500-10-20B.....	153
302-118.....	82	302-274.....	78	302-415NL.....	80	322-526.....	82	500-10-20R.....	153
302-203.....	91	302-274NL.....	78	302-416NL.....	80	322-533.....	82	500-10-300.....	153
302-203NL.....	91	302-275.....	78	302-417NL.....	80	322-534.....	82	500-10-300B.....	153
302-204.....	91	302-275NL.....	78	302-418NL.....	80	322-602.....	82	500-10-300R.....	153
302-204NL.....	91	302-283.....	78	302-423NL.....	80	322-611.....	82	500-10-500.....	153
302-205.....	91	302-283NL.....	78	302-424NL.....	80	322-612.....	82	500-10-500B.....	153
302-205NL.....	91	302-284.....	78	302-425NL.....	80	322-614.....	82	500-10-500R.....	153
302-206.....	91	302-284NL.....	78	302-433.....	81	322-615.....	82	500-112-20.....	153
302-206NL.....	91	302-285.....	78	302-434.....	81	322-634.....	82	500-114-20.....	153
302-207.....	91	302-285NL.....	78	302-435.....	81	322-644.....	82	500-12-10.....	152
302-207NL.....	91	302-291.....	78	302-436.....	81	322-653.....	82	500-12-100.....	152
302-210NL.....	72	302-291NL.....	78	302-437.....	81	322-664.....	82	500-12-1000.....	152
302-213.....	91	302-293.....	80	302-438.....	81	322-729.....	82	500-12-1000B.....	152
302-214.....	91	302-293NL.....	80	302-443.....	81	322-730.....	82	500-12-1000R.....	152
302-215.....	91	302-300NL.....	80	302-444.....	81	322-731.....	82	500-12-100B.....	152
302-216.....	91	302-301NL.....	80	302-445.....	81	322-733.....	82	500-12-100R.....	152
302-217.....	91	302-302NL.....	80	302-446.....	81	322-734.....	82	500-12-10B.....	152
302-218NL.....	77	302-303NL.....	80	302-447.....	81	322-736.....	82	500-12-10R.....	152
302-219.....	77	302-304NL.....	80	302-448.....	81	322-740.....	82	500-12-20.....	152
302-219NL.....	77	302-305NL.....	80	302-603.....	81	322-744.....	82	500-12-20B.....	152
302-220NL.....	77	302-306NL.....	80	302-604.....	81	322-750.....	82	500-12-20R.....	152
302-221.....	77	302-307NL.....	80	302-605.....	81	322-751.....	82	500-12-300.....	152
302-221NL.....	77	302-308NL.....	80	302-606.....	81	324-101.....	83	500-12-300B.....	152
302-222.....	77	302-309NL.....	80	302-607.....	81	324-103.....	83	500-12-300R.....	152
302-222NL.....	77	302-310NL.....	80	302-608.....	81	324-123.....	83	500-12-500.....	152
302-223.....	77	302-311NL.....	80	302-609.....	81	355-392.....	90	500-12-500B.....	152
302-223NL.....	77	302-316NL.....	80	302-610.....	81	355-393.....	90	500-12-500R.....	152
302-224.....	77	302-317NL.....	80	302-611.....	81	355-394.....	90	500-14-100.....	152
302-224NL.....	77	302-318NL.....	80	302-624.....	81	355-402.....	90	500-20-20.....	153
302-225.....	77	302-321.....	79	302-625.....	81	355-403.....	90	500-34-10.....	152
302-225NL.....	77	302-321NL.....	79	302-626.....	81	355-404.....	90	500-34-100.....	152
302-226.....	77	302-322.....	79	302-627.....	81	355-405.....	90	500-34-1000.....	153
302-226NL.....	77	302-322NL.....	79	302-628.....	81	355-406.....	90	500-34-1000B.....	153
302-228.....	77	302-323.....	79	302-629.....	81	355-412.....	90	500-34-1000R.....	153
302-228NL.....	77	302-323NL.....	79	302-630.....	81	355-413.....	90	500-34-100B.....	152
302-229.....	78	302-333NL.....	79	302-631.....	81	355-414.....	90	500-34-100R.....	153
302-229NL.....	78	302-334NL.....	79	302-632.....	81	355-415.....	90	500-34-10B.....	152
302-231.....	78	302-342NL.....	79	302-635.....	81	355-416.....	90	500-34-10R.....	152
302-231NL.....	78	302-343.....	79	303-103.....	76	355-422.....	90	500-34-20.....	152
302-232.....	77	302-343NL.....	79	303-104.....	76	355-423.....	90	500-34-20B.....	152
302-232NL.....	77	302-344.....	79	303-105.....	76	355-424.....	90	500-34-20R.....	152
302-233.....	79	302-344NL.....	79	303-106.....	76	355-425.....	90	500-34-300.....	153
302-233NL.....	79	302-354.....	79	303-107.....	76	355-426.....	90	500-34-300B.....	153
302-234.....	78	302-354NL.....	79	303-108.....	76	355-432.....	90	500-34-300R.....	153
302-234NL.....	78	302-355.....	79	303-123.....	76	355-433.....	90	500-34-500.....	153
302-235NL.....	77	302-355NL.....	79	303-123NL.....	76	355-434.....	90	500-34-500B.....	153
302-236NL.....	77	302-356.....	79	303-124.....	76	355-435.....	90	500-34-500R.....	153
302-238.....	81	302-356NL.....	79	303-124NL.....	76	355-436.....	90	500-38-100.....	152
302-243.....	78	302-357.....	79	303-125.....	76	355-442.....	90	500-38-1000.....	152
302-243NL.....	78	302-357NL.....	79	303-125NL.....	76	456-003NL.....	18	500-38-500.....	152
302-252.....	78	302-358.....	79	303-126.....	76	456-004NL.....	18	508-255.....	154
302-252NL.....	78	302-358NL.....	79	303-126NL.....	76	456-005NL.....	18	508-256.....	154
302-253.....	78	302-363.....	79	303-127.....	76	456-013NL.....	19	508-260.....	154
302-253NL.....	78	302-363NL.....	79	303-127NL.....	76	456-014NL.....	19	508-261.....	154
302-254.....	78	302-373.....	79	303-128.....	76	456-015NL.....	19	508-280.....	154
302-254NL.....	78	302-373NL.....	79	303-128NL.....	76	456-023NL.....	19	508-281.....	154
302-255.....	78	302-384.....	79	303-129.....	76	456-024NL.....	19	509-003.....	98
302-255NL.....	78	302-384NL.....	79	303-129NL.....	76	456-025NL.....	19	509-003.....	155

509-004.....98	800-352.....100	800-719.....141	800-856R.....117	800-QT3200.....96
509-004.....155	800-353.....100	800-761.....138	800-856T.....107	807-001.....140
509-005.....98	800-354.....100	800-762.....138	800-856T.....117	807-002.....140
509-005.....155	800-355.....100	800-765F.....138	800-857.....108	807-003.....140
509-013.....98	800-356.....100	800-765P.....138	800-857.....116	807-031.....140
509-013.....155	800-362.....97	800-765VC.....138	800-858.....108	807-032.....140
509-014.....98	800-364.....97	800-765VF.....138	800-858.....116	807-033.....140
509-014.....155	800-373.....99	800-766.....133	800-860.....117	807-071.....140
509-023.....98	800-373.....155	800-766F.....138	800-861.....108	807-072.....140
509-023.....155	800-374.....99	800-766M.....138	800-861.....117	807-073.....140
8000-10-2.....104	800-374.....155	800-766P.....138	800-863.....142	8100-10-10.....110
8000-10-ER.....107	800-375.....99	800-766S.....138	800-864.....142	8100-10-11.....110
8000-10-ES.....107	800-375.....155	800-766VF.....138	800-865.....108	8100-10-12.....110
8000-14-ER.....107	800-500.....100	800-802.....116	800-865.....117	8100-10-2.....110
8000-14-ES.....107	800-501.....100	800-802.....137	800-866.....108	8100-10-3.....110
8000-14-MR.....107	800-503.....97	800-803.....116	800-866.....117	8100-10-4.....110
8000-14-MS.....107	800-513.....99	800-805.....108	800-867.....122	8100-10-5.....110
8000-14-XP.....107	800-513.....155	800-805.....116	800-874F.....132	8100-10-6.....110
8000A-10-2.....104	800-514.....99	800-806.....108	800-874LP.....132	8100-10-7.....110
8000AP-10-2.....106	800-514.....155	800-806.....116	800-874M.....132	8100-10-8.....110
8000P-10-2.....105	800-515.....99	800-815.....118	800-874S.....132	8100-10-9.....110
8000P-14-2.....106	800-515.....155	800-816.....118	800-874VC.....132	8100-10-XP.....111
8000S-10-2.....105	800-523.....99	800-825.....117	800-874VF.....132	8100A-10-10.....110
8000SP-10-2.....106	800-523.....155	800-825.....108	800-875.....133	8100A-10-11.....110
8000T-10-2.....105	800-524.....99	800-835.....133	800-875F.....132	8100A-10-12.....110
800-134.....123	800-524.....155	800-835F.....136	800-875LP.....132	8100A-10-2.....110
800-135.....123	800-525.....99	800-835M.....136	800-875M.....132	8100A-10-3.....110
800-140.....118	800-525.....155	800-835P.....136	800-875S.....132	8100A-10-4.....110
800-141.....118	800-652.....90	800-835S.....136	800-875VC.....132	8100A-10-5.....110
800-142.....118	800-653.....90	800-835VC.....136	800-875VF.....132	8100A-10-6.....110
800-143.....118	800-654.....90	800-835VF.....136	800-876.....133	8100A-10-7.....110
800-143C.....119	800-654.....143	800-836.....133	800-876F.....132	8100A-10-8.....110
800-143P.....119	800-655.....90	800-836F.....136	800-876LP.....132	8100A-10-9.....110
800-144.....118	800-655.....143	800-836M.....136	800-876M.....132	8100P-10-10.....109
800-144C.....119	800-662.....89	800-836P.....136	800-876S.....132	8100P-10-11.....109
800-144P.....119	800-662.....142	800-836S.....136	800-876VF.....132	8100P-10-12.....109
800-145.....118	800-663.....89	800-836VF.....136	800-877.....133	8100P-10-2.....109
800-145C.....119	800-663.....142	800-837.....133	800-877F.....132	8100P-10-3.....109
800-145P.....119	800-664.....89	800-837F.....136	800-877LP.....132	8100P-10-4.....109
800-200.....118	800-664.....142	800-837M.....136	800-877M.....132	8100P-10-5.....109
800-234.....123	800-665.....89	800-837P.....136	800-877S.....132	8100P-10-6.....109
800-235.....123	800-665.....142	800-837S.....136	800-881.....137	8100P-10-7.....109
800-244.....123	800-667.....143	800-837U.....136	800-884F.....134	8100P-10-8.....109
800-245.....137	800-668.....143	800-838U.....136	800-884M.....134	8100P-10-9.....109
800-246.....137	800-669.....143	800-841.....139	800-884P.....134	810-100.....111
800-250.....155	800-673.....89	800-842.....139	800-884S.....134	810-102.....111
800-251.....155	800-673.....142	800-845.....107	800-884VC.....134	810-103.....112
800-252.....155	800-675.....89	800-845.....118	800-884VF.....134	810-104.....112
800-253.....155	800-675.....142	800-846.....107	800-885F.....135	810-105.....110
800-304.....97	800-683.....89	800-846.....118	800-885M.....135	810-106.....111
800-305.....97	800-684.....89	800-853.....116	800-885P.....135	810-107.....111
800-313.....97	800-692.....89	800-855.....107	800-885S.....135	810-142EP.....112
800-314.....97	800-692.....143	800-855.....117	800-885VC.....135	810-143EP.....112
800-323.....98	800-693.....89	800-855.....122	800-885VF.....135	810-144EP.....112
800-324.....98	800-693.....143	800-855B.....107	800-886F.....135	810-145EP.....112
800-332.....116	800-703.....141	800-855B.....117	800-886M.....135	8200-10-10.....115
800-333.....98	800-704.....141	800-855R.....107	800-886P.....135	8200-10-11.....115
800-334.....98	800-704NE.....141	800-855R.....117	800-886S.....135	8200-10-12.....115
800-340.....100	800-705.....141	800-855T.....107	800-886VF.....135	8200-10-2.....115
800-340-34.....100	800-706.....141	800-855T.....117	800-887F.....135	8200-10-3.....115
800-340-40.....100	800-709.....141	800-855T.....122	800-887M.....135	8200-10-4.....115
800-340-55.....100	800-710.....141	800-856.....107	800-887P.....135	8200-10-5.....115
800-345.....97	800-713.....141	800-856.....117	800-887S.....135	8200-10-6.....115
800-348.....97	800-714.....141	800-856B.....107	800-QT100.....96	8200-10-7.....115
800-349.....96	800-715.....141	800-856B.....117	800-QT100R.....96	8200-10-8.....115
800-351.....100	800-716.....141	800-856R.....107	800-QT200.....96	8200-10-9.....115

INDEX BY PART NUMBER

8200-14-10.....	116	8200T-10-5.....	115	8300E-10-7.....	128	833-855.....	129
8200-14-11.....	116	8200T-10-6.....	115	8300E-10-8.....	128	833-855B.....	129
8200-14-12.....	116	8200T-10-7.....	115	8300E-10-9.....	128	833-855R.....	129
8200-14-4.....	116	8200T-10-8.....	115	8300EV-10-10.....	128	833-861.....	130
8200-14-5.....	116	8200T-10-9.....	115	8300EV-10-11.....	128	833-862.....	131
8200-14-6.....	116	8200T-14-10.....	115	8300EV-10-12.....	128	8400-25-4.....	124
8200-14-7.....	116	8200T-14-11.....	115	8300EV-10-2.....	128	8400-25-6.....	124
8200-14-8.....	116	8200T-14-12.....	115	8300EV-10-3.....	128	8400-25-8.....	124
8200-14-9.....	116	8200T-14-4.....	115	8300EV-10-4.....	128	850-125.....	101
8200AP-10-10.....	114	8200T-14-5.....	115	8300EV-10-5.....	128	850-129.....	101
8200AP-10-11.....	114	8200T-14-6.....	115	8300EV-10-6.....	128	850-133.....	101
8200AP-10-12.....	114	8200T-14-7.....	115	8300EV-10-7.....	128	850-135.....	101
8200AP-10-2.....	114	8200T-14-8.....	115	8300EV-10-8.....	128	850-139.....	101
8200AP-10-3.....	114	8200T-14-9.....	115	8300EV-10-9.....	128	850-144.....	101
8200AP-10-4.....	114	8220-15-2.....	120	830-140.....	130	850-149.....	101
8200AP-10-5.....	114	8220-15-2X.....	121	830-142.....	130	850-151.....	102
8200AP-10-6.....	114	8220-15-3.....	120	830-142C.....	130	850-155.....	102
8200AP-10-7.....	114	8220-15-3X.....	121	830-143.....	130	850-155.....	102
8200AP-10-8.....	114	8220-15-4.....	120	830-143C.....	130	850-161.....	102
8200AP-10-9.....	114	8220-15-4X.....	121	830-143P.....	130	850-165.....	102
8200P-10-10.....	113	8220-15-5.....	120	830-144.....	130	860-020.....	147
8200P-10-11.....	113	8220-15-5X.....	121	830-144C.....	130	860-023.....	147
8200P-10-12.....	113	8220-15-6.....	120	830-145.....	130	860-024.....	147
8200P-10-2.....	113	8220-15-6X.....	121	830-145C.....	130	860-025.....	147
8200P-10-3.....	113	8220-15-7.....	120	830-201.....	129	860-100.....	147
8200P-10-4.....	113	8220-15-7X.....	121	830-201S.....	129	860-333.....	147
8200P-10-5.....	113	8220-15-8.....	120	830-10-10.....	127	800-660.....	143
8200P-10-6.....	113	8220-15-8X.....	121	8330-10-11.....	127	900-090.....	36
8200P-10-7.....	113	8220-20-2.....	120	8330-10-12.....	127	900-091.....	36
8200P-10-8.....	113	8220-20-2X.....	121	8330-10-2.....	127	900-092.....	36
8200P-10-9.....	113	8220-20-3.....	120	8330-10-3.....	127	900-093.....	36
8200P-14-10.....	113	8220-20-3X.....	121	8330-10-4.....	127	900-094.....	36
8200P-14-11.....	113	8220-20-4.....	120	8330-10-5.....	127	900-095.....	36
8200P-14-12.....	113	8220-20-4X.....	121	8330-10-6.....	127	900-096.....	36
8200P-14-4.....	113	8220-20-5.....	120	8330-10-7.....	127	900-097.....	36
8200P-14-5.....	113	8220-20-5X.....	121	8330-10-8.....	127	833-815.....	129
8200P-14-6.....	113	8220-20-6.....	120	8330-10-9.....	127	VT-HTRP.....	95
8200P-14-7.....	113	8220-20-6X.....	121	8330AP-10-10.....	127	VT-LF.....	95
8200P-14-8.....	113	8220S-15-2.....	121	8330AP-10-11.....	127	VT-MP.....	94
8200P-14-9.....	113	8220S-15-3.....	121	8330AP-10-12.....	127	VT-RP.....	94
8200SP-10-10.....	114	8220S-15-4.....	121	8330AP-10-2.....	127	VT-RPH.....	95
8200SP-10-11.....	114	8220S-15-5.....	121	8330AP-10-3.....	127	VT-RRC.....	95
8200SP-10-12.....	114	8220S-15-6.....	121	8330AP-10-4.....	127	VT-RTS.....	94
8200SP-10-2.....	114	8220S-15-7.....	121	8330AP-10-5.....	127	VT-SM.....	95
8200SP-10-3.....	114	8220S-15-8.....	121	8330AP-10-6.....	127		
8200SP-10-4.....	114	8220S-20-2.....	121	8330AP-10-7.....	127		
8200SP-10-5.....	114	8220S-20-3.....	121	8330AP-10-8.....	127		
8200SP-10-6.....	114	8220S-20-4.....	121	8330AP-10-9.....	127		
8200SP-10-7.....	114	8220S-20-5.....	121	8330P-10-10.....	126		
8200SP-10-8.....	114	8220S-20-6.....	121	8330P-10-11.....	126		
8200SP-10-9.....	114	822-817.....	122	8330P-10-12.....	126		
8200SP-14-10.....	114	822-818.....	122	8330P-10-2.....	126		
8200SP-14-11.....	114	822-857.....	122	8330P-10-3.....	126		
8200SP-14-12.....	114	822-861.....	123	8330P-10-4.....	126		
8200SP-14-4.....	114	822-862.....	123	8330P-10-5.....	126		
8200SP-14-5.....	114	822-863.....	123	8330P-10-6.....	126		
8200SP-14-6.....	114	822-867.....	123	8330P-10-7.....	126		
8200SP-14-7.....	114	822-868.....	123	8330P-10-8.....	126		
8200SP-14-8.....	114	8300E-10-10.....	128	8330P-10-9.....	126		
8200SP-14-9.....	114	8300E-10-11.....	128	833-141.....	130		
8200T-10-10.....	115	8300E-10-12.....	128	833-805.....	129		
8200T-10-11.....	115	8300E-10-2.....	128	833-825.....	129		
8200T-10-12.....	115	8300E-10-3.....	128	833-825B.....	129		
8200T-10-2.....	115	8300E-10-4.....	128	833-825R.....	129		
8200T-10-3.....	115	8300E-10-5.....	128	833-835R.....	129		
8200T-10-4.....	115	8300E-10-6.....	128	833-845.....	131		

Thank you for choosing Legend.

**Downstream
Thinking**
It's all about Performance



Made in the USA



300 N. Opdyke Rd.

Auburn Hills, MI 48326

Phone: 800-752-2082

Fax: 800-835-4457

web: www.legendvalve.com

email: service@legendvalve.com



LT-CWS0616