

**WARD**  **FITTINGS**

# WARD FITTINGS

PRICE SCHEDULE #290916

EFFECTIVE: SEPTEMBER 6, 2016



**WARD**  **MFG**

117 Gulick Street, Blossburg, PA 16912 [www.wardmfg.com](http://www.wardmfg.com) (800) 248-1027

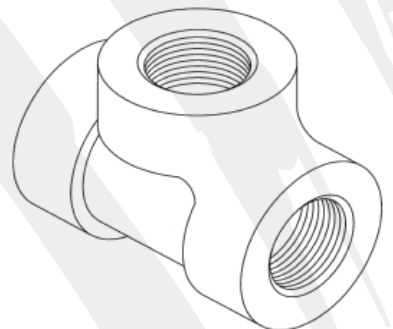

## TERMS AND CONDITIONS OF SALE:

1. **PRICES:** This price sheet supersedes all previous issues. Prices in price sheets are subject to change without notice. Prices apply only to standard sizes as listed in catalog.
2. **APPROVAL & ACCEPTANCE OF ORDERS:** All orders are accepted on the basis of prices in effect at the time of shipment.
3. **TAXES:** Any Manufacturer or Sales Tax payable on the transaction under any effective statute will be added to the prices and terms quoted, unless a valid exemption certificate is on file.
4. **CREDIT TERMS:** Two percent cash discount tenth prox., - Net 30 days. Unless otherwise stated.
5. **DELIVERY & SHIPMENT OF GOODS:** All goods are shipped at buyer's risk. Shipments should be carefully examined upon delivery and before the carrier's delivery receipt is signed. If any loss or damage is evident, the buyer should make an appropriate notation on the delivery receipt and insist that the carrier's driver initial such exception. The contents of all packages should be carefully examined for concealed damage as soon as possible after delivery, so that the carrier can be requested, within 48 hours after delivery, to arrange for prompt inspection of the damaged goods. Completion of all orders accepted and fulfillment of all agreements or contracts entered into are subject to any delay which might be occasioned by labor disputes, fires, accidents, embargoes, trade restrictions, governmental directives or other causes beyond our control. All promises of shipment will be as closely estimated as possible. We use our efforts in every case to ship within the time promised, but cannot guarantee to do so. All claims for shortage must be made on receipt of goods. We prove our count by weighing the package. Claims for shortage are subject to that test. Typographical, clerical, arithmetical errors or omissions in orders, invoices, quotations, price schedules, acknowledgments, or other documents are subject to correction.
6. **RETURN OF GOODS:** No goods will be taken back and credited without prior approval and issuance of a return goods authorization (RGA) number. All fittings returned with our permission must be goods sold by Ward Manufacturing, LLC, and in clean saleable condition. Credit will only be allowed on the basis of prices agreed upon. If product returned is a result of a customer ordering error or overstocking situation, the credit will be less 20 percent to cover handling costs, less any costs of returning to a saleable condition, and less transportation charges on original and return shipments. Orders for special goods are not subject to cancellation for any reason after work has been started on them, except upon agreement to make payment for all work which has been performed.
7. **WARRANTY:** Seller warrants the material to be free of defects in material and workmanship, under normal use, proper maintenance and proper operation, for a period of one year from date of delivery to a common carrier for shipment to buyer or his designated agent. The obligation of the seller is limited to (1) repair of the material, or (2) replacement of any component or components proven defective in material or workmanship, or (3) refund of the purchase price. Seller shall have no liability for the cost of removal or reinstallation with respect to any replaced or repaired product. The election of said remedies shall be determined by seller in its sole discretion and shall be considered final disposition. All implied warranties, including the implied warranties of merchantability and fitness for a particular purpose, are hereby disclaimed and excluded. This warranty is in lieu of all other warranties, guarantees, agreements and similar obligations of seller; in no event shall seller be liable for consequential or incidental damages.
8. **FREIGHT TERM:** Shipments of 2,000 lb. net or more will be prepaid in the continental U.S. (except Alaska). We reserve the right to choose shipping point and carrier.
9. **CARTON & BOX QUANTITY ADJUSTMENT:** On orders received for less than master carton or box quantities, we reserve the right to adjust to the next carton or box quantity above the number of pieces shown on the order. Items subject to adjustment are identified with stars in the price sheet.
10. **WEIGHTS:** The weights per piece or per 100 pieces given in the price sheet, catalogs, and quotations are not guaranteed, but are approximate and for your convenience.
12. **SPECIAL CONDITIONS:** Any additional cost incurred in packaging or in making any special tests or inspection requested by Buyer in addition to those commercially supplied by Ward Manufacturing, LLC., will be charged to Buyer. Such tests and inspections will be made at the factory before date of shipment. Orders for fittings or parts will be subject to a net minimum invoice charge of \$35.00 Net plus applicable handling and freight charges.
13. **US EXPORT COMPLIANCE:** The products sold by Ward Manufacturing, LLC. may be subject to the export control laws and regulations of the United States Government. Buyer may not make any disposition of such products, by way of sale, export, re-export, transshipment or otherwise, except as permitted under applicable U.S. law.

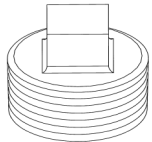

**CAST IRON PLUGS  
- REGULAR CORED**

Fig. 01 & 02

DESCRIPTION	PCS PER BOX	PCS PER MASTER	WEIGHT PER 100	PART # BLACK		PRICE (US\$) BLACK	PART # GALV.		PRICE (US\$) GALV.
1/2	100	600	10	D.BP	*	3.81	D.NP	*	8.08
3/4	70	420	15	E.BP	*	4.80	E.NP	*	10.27
1	40	240	25	1.BP	*	4.80	1.NP	*	10.27
1-1/4	40	160	43	1B.BP	*	7.65	1B.NP	*	17.13
1-1/2	40	80	64	1D.BP	*	10.83	1D.NP	*	23.14
2	25	50	94	2.BP	*	12.65	2.NP	*	28.74
2-1/2	20	40	130	2D.BP		30.80	2D.NP		60.73
3	10	20	198	3.BP	*	35.68	3.NP		77.76
3-1/2	10	20	208	3D.BP		87.05	3D.NP		142.01
4 SQUARE HEAD	5	10	409	4.BPSH		74.16	4.NPSH		213.40
4 BAR HEAD	5	10	399	4.BP	*	73.49	4.NP		150.82
5 BAR HEAD	5	5	627	5.BP		138.14	5.NP		299.84
6 BAR HEAD	4	4	970	6.BP		180.34	6.NP		341.10

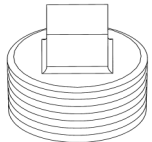

**CAST IRON PLUGS  
- SOLID**

Fig. 03 & 04

DESCRIPTION	PCS PER BOX	PCS PER MASTER	WEIGHT PER 100	PART # BLACK		PRICE (US\$) BLACK	PART # GALV.		PRICE (US\$) GALV.
1/2	100	600	10	D.BSP	*	4.25	D.NSP	*	9.52
3/4	50	300	17	E.BSP	*	12.84	E.NSP		27.18
1	30	180	33	1.BSP	*	13.67	1.NSP		30.81
1-1/4	30	120	57	1B.BSP	*	15.74	1B.NSP		33.58
1-1/2	40	80	80	1D.BSP	*	22.31	1D.NSP		44.77
2	25	50	125	2.BSP		28.80	2.NSP		63.79
2-1/2	10	20	195	2D.BSP		42.62	2D.NSP		82.11
3	10	20	350	3.BSP		72.72	3.NSP		144.84
4 BAR HEAD	5	10	576	4.BSP		161.71	4.NSP		284.18
5 BAR HEAD	5	5	970	5.BSP		300.56			

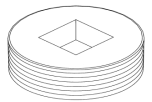

**CAST IRON  
COUNTERSUNK  
PLUGS**

Fig. 05

DESCRIPTION	PCS PER BOX	PCS PER MASTER	WEIGHT PER 100	PART # BLACK		PRICE (US\$) BLACK	PART # GALV.		PRICE (US\$) GALV.
1/2 MI	100	600	6	D.BCTP		8.70	D.NCTP		13.10
3/4 MI	80	480	10	E.BCTP		11.83	E.NCTP		20.38
1 MI	40	240	22	1.BCTP		16.57	1.NCTP		32.55
1-1/4	40	160	35	1B.BCTP		17.32	1B.NCTP		34.43
1-1/2	50	100	48	1D.BCTP		20.73	1D.NCTP		46.28
2	40	80	84	2.BCTP		30.59	2.NCTP		64.80
2-1/2	20	40	150	2D.BCTP		48.36	2D.NCTP		96.28
3	10	20	225	3.BCTP		78.98	3.NCTP		147.12
4	5	5	390	4.BCTP		212.86	4.NCTP		435.56

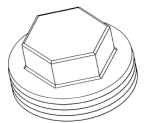

**HEX HEAD  
CLEANOUT  
PLUGS**

Fig. 06

DESCRIPTION	PCS PER BOX	PCS PER MASTER	WEIGHT PER 100	PART # BLACK		PRICE (US\$) BLACK	PART # GALV.		PRICE (US\$) GALV.
1-1/4	1	1	28	1B.BCOP		9.51	1B.NCOP		16.94
4	1	1	172	4.BCOP		60.01	4.NCOP		153.77

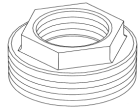

**HEXAGON BUSHINGS**

DESCRIPTION	PCS PER BOX	PCS PER MASTER	WEIGHT PER 100	PART # BLACK	PRICE (US\$) BLACK	PART # GALV.	PRICE (US\$) GALV.
1-1/4 x 1/8	25	150	36	1BXA.BB	16.31	1BXA.NB	* 27.99
1-1/4 x 1/4	25	150	36	1BXB.BB	16.82	1BXB.NB	28.67
1-1/4 x 3/8	25	150	34	1BXC.BB	* 14.09	1BXC.NB	28.67
1-1/4 x 1/2	25	150	31	1BXD.BB	* 13.03	1BXD.NB	* 24.43
1-1/4 x 3/4	25	150	38	1BXE.BB	* 11.45	1BXE.NB	* 21.56
1-1/4 x 1	Ward2	150	30	1BX1.BB	* 11.45	1BX1.NB	* 21.56
1-1/2 x 1/8	30	120	62	1DXA.BB	18.31	1DXA.NB	34.66
1-1/2 x 1/4	15	90	49	1DXB.BB	* 19.60	1DXB.NB	* 38.63
1-1/2 x 3/8	30	120	47	1DXC.BB	* 22.23	1DXC.NB	* 38.63
1-1/2 x 1/2	30	120	40	1DXD.BB	* 14.90	1DXD.NB	* 30.03
1-1/2 x 3/4	30	120	43	1DXE.BB	* 14.90	1DXE.NB	* 30.03
1-1/2 x 1	30	120	47	1DX1.BB	* 13.08	1DX1.NB	* 27.13
2 x 1/4	20	80	73	2XBB.BB	* 21.14	2XBB.NB	44.75
2 x 3/8	20	80	71	2XC.BB	* 26.62	2XC.NB	44.77
2 x 1/2	20	80	60	2XD.BB	* 23.67	2XD.NB	* 37.63
2 x 3/4	20	80	61	2XE.BB	* 18.72	2XE.NB	* 34.98
2 x 1	20	80	75	2X1.BB	* 17.89	2X1.NB	* 34.98
2 x 1-1/4	20	80	85	2X1B.BB	* 17.89	2X1B.NB	* 34.98
2-1/2 x 1/2	20	20	102	2DXD.BB	30.69	2DXD.NB	63.71
2-1/2 x 3/4	20	20	120	2DXE.BB	32.91	2DXE.NB	63.71
2-1/2 x 1	20	20	90	2DX1.BB	32.91	2DX1.NB	63.71
2-1/2 x 1-1/4	20	20	105	2DX1B.BB	32.91	2DX1B.NB	63.71
2-1/2 x 1-1/2	20	20	111	2DX1D.BB	28.64	2DX1D.NB	57.35
2-1/2 x 2	20	20	113	2DX2.BB	* 28.21	2DX2.NB	50.21
3 x 1/4	10	20	197	3XBB.BB	40.68	3XBB.NB	77.95
3 x 1/2	10	20	155	3XD.BB	49.54	3XD.NB	84.04
3 x 3/4	10	20	190	3XE.BB	48.36	3XE.NB	84.04
3 x 1	10	20	168	3X1.BB	44.50	3X1.NB	84.04
3 x 1-1/4	10	20	152	3X1B.BB	44.50	3X1B.NB	82.09
3 x 1-1/2	10	20	157	3X1D.BB	44.50	3X1D.NB	75.63
3 x 2	10	20	164	3X2.BB	33.23	3X2.NB	65.35
3 x 2-1/2	10	10	161	3X2D.BB	38.52	3X2D.NB	70.15
3-1/2 x 3/4	10	10	228	3DXE.BB	86.64		
3-1/2 x 1	10	10	219	3DX1.BB	86.64	3DX1.NB	136.21
3-1/2 x 1-1/4	10	10	212	3DX1B.BB	86.64	3DX1B.NB	136.21
3-1/2 x 1-1/2	10	10	234	3DX1D.BB	86.64	3DX1D.NB	149.24
3-1/2 x 2	10	10	190	3DX2.BB	84.61	3DX2.NB	149.24
3-1/2 x 2-1/2	10	10	198	3DX2D.BB	86.64	3DX2D.NB	149.24
4 x 1/2	10	10	291	4XD.BB	92.57	4XD.NB	163.46
4 x 1	10	10	273	4X1.BB	100.85	4X1.NB	176.12
4 x 1-1/4	10	10	250	4X1B.BB	100.85	4X1B.NB	176.12
4 x 1-1/2	10	10	286	4X1D.BB	92.87	4X1D.NB	176.12
4 x 2	10	10	270	4X2.BB	74.95	4X2.NB	137.21
4 x 2-1/2	10	10	280	4X2D.BB	90.70	4X2D.NB	176.12
4 x 3	10	10	318	4X3.BB	74.95	4X3.NB	137.21
5 x 2	10	10	445	5X2.BB	174.69	5X2.NB	297.75
5 x 2-1/2	10	10	543	5X2D.BB	174.69	5X2D.NB	271.78
5 x 3	10	10	496	5X3.BB	157.17	5X3.NB	297.75
5 x 4	10	10	474	5X4.BB	152.64	5X4.NB	290.79
6 x 2	6	6	650	6X2.BB	180.21	6X2.NB	336.85
6 x 2-1/2	6	6	620	6X2D.BB	200.29	6X2D.NB	338.96
6 x 3	6	6	752	6X3.BB	180.21	6X3.NB	336.85
6 x 4	6	6	788	6X4.BB	156.01	6X4.NB	317.78
6 x 5	6	6	617	6X5.BB	180.18	6X5.NB	336.85
8 x 4	2	2	1828	8X4.BB	377.20	8X4.NB	632.41

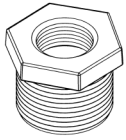

**TANK BUSHINGS,  
DOUBLE TAPPED  
HVY TYPE ONLY**

DESCRIPTION	PCS PER BOX	PCS PER MASTER	WEIGHT PER 100	PART # BLACK	PRICE (US\$) BLACK	PART # GALV.	PRICE (US\$) GALV.
1 x 1/2 x 1/2	50	50	37	1XD.BTB	18.84	1XD.NTB	31.46
1-1/2 x 1 x 1	40	40	66	1DX1.BTB	27.42	1DX1.NTB	45.75
2 x 3/8 x 3/8	20	20	174	2XC.BTB	36.99	2XC.NTB	50.64
2 x 1/2 x 1/2	20	20	165	2XD.BTB	36.99	2XD.NTB	61.65
2 x 3/4 x 3/4	20	20	155	2XE.BTB	36.99	2XE.NTB	61.65
2 x 1 x 1	20	20	136	2X1.BTB	36.99	2X1.NTB	61.65
2 x 1-1/4 x 1-1/4	20	20	120	2X1B.BTB	36.99	2X1B.NTB	61.65
2 x 1-1/2 x 1-1/2	20	20	89	2X1D.BTB	36.99	2X1D.NTB	61.65
3 x 1 x 1	10	10	525	3X1.BTB	74.97	3X1.NTB	122.25
3 x 2 x 2	10	10	350	3X2.BTB	74.97	3X2.NTB	122.25
4 x 1 x 1	5	5	650	4X1.BTB	135.63	4X1.NTB	226.30
4 x 1-12 x 1-1/2	5	5	334	4X1D.BTB	135.63	4X1D.NTB	226.30
4 x 2 x 2	5	5	349	4X2.BTB	135.63	4X2.NTB	226.30
4 x 2-1/2 x 2-1/2	5	5	601	4X2D.BTB	135.63	4X2D.NTB	226.30
4 x 3 x 3	5	5	425	4X3.BTB	147.12	4X3.NTB	245.32

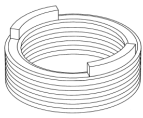

**FLUSH BUSHINGS**

Fig. 10

DESCRIPTION	PCS PER BOX	PCS PER MASTER	WEIGHT PER 100	PART # BLACK	PRICE (US\$) BLACK	PART # GALV.	PRICE (US\$) GALV.
1-1/4 x 1/2	25	150	30	1BXD.BFB	19.44	1BXD.NFB	51.04
1-1/4 x 3/4	25	150	27	1BXE.BFB	18.88	1BXE.NFB	51.04
1-1/2 x 3/4	30	120	40	1DXE.BFB	34.67	1DXE.NFB	70.68
1-1/2 x 1	30	120	32	1DX1.BFB	* 30.03	1DX1.NFB	* 68.44
2 x 1/2	20	80	66	2XD.BFB	45.68	2XD.NFB	96.86
2 x 3/4	20	80	70	2XE.BFB	39.38	2XE.NFB	85.47
2 x 1	20	80	62	2X1.BFB	* 40.45	2X1.NFB	* 87.75
2 x 1-1/4	20	80	54	2X1B.BFB	40.45	2X1B.NFB	87.75
2-1/2 x 1-1/4	20	20	100	2DX1B.BFB	43.86	2DX1B.NFB	108.52
3 x 1-1/2	10	10	95	3X1D.BFB	96.44	3X1D.NFB	145.77
3 x 2	10	10	134	3X2.BFB	98.10	3X2.NFB	164.31
3-1/2 x 2-1/2	10	10	171	3DX2D.BFB	132.35	3DX2D.NFB	252.65
4 x 2	10	10	280	4X2.BFB	225.40	4X2.NFB	349.85
4 x 2-1/2	10	10	252	4X2D.BFB	170.36	4X2D.NFB	352.40
4 x 3	10	10	200	4X3.BFB	186.67	4X3.NFB	352.40
5 x 4	10	10	300	5X4.BFB	225.40	5X4.NFB	349.85
6 x 4	6	6	550	6X4.BFB	360.06	6X4.NFB	694.70
6 x 5	6	6	375	6X5.BFB	346.20	6X5.NFB	631.37
8 x 6	2	2	925	8X6.BFB	933.81	8X6.NFB	1927.90
8 x 6	2	2	925	8X6.BFB	933.81	8X6.NFB	1927.90



Fig. 21

**CAST IRON  
90° ELBOWS  
CLASS 125**

DESCRIPTION	PCS PER BOX	PCS PER MASTER	WEIGHT PER 100	PART # BLACK		PRICE (US\$) BLACK	PART # GALV.		PRICE (US\$) GALV.
1/4	25	150	17	B.BCL	*	15.08	B.NCL		25.27
3/8	25	150	25	C.BCL	*	21.84	C.NCL		25.27
1/2	100	100	41	D.BCL	*	9.56	D.NCL		28.80
3/4	100	100	69	E.BCL	*	9.96	E.NCL		28.27
1	50	50	104	1.BCL	*	11.80	1.NCL		32.67
1-1/4	25	25	158	1B.BCL	*	16.75	1B.NCL		50.85
1-1/2	25	25	209	1D.BCL	*	23.16	1D.NCL		69.83
2	15	15	339	2.BCL	*	36.20	2.NCL		103.12
2-1/2	10	10	514	2D.BCL	*	86.73	2D.NCL		211.62
3	6	6	787	3.BCL		142.03	3.NCL		321.89
3-1/2	3	3	955	3D.BCL		385.77			
4	2	2	1323	4.BCL		263.31	4.NCL		589.76
5	1	1	2040	5.BCL		576.86			
6	1	1	2985	6.BCL		747.51			
8	1	1	6456	8.BCL		1827.91			
1/2 x 1/4	1	1	40	DXB.BCL		23.56			
3/4 x 1/2	100	100	56	EXD.BCL	*	20.11	EXD.NCL		32.70
1 x 3/4	50	50	92	1XE.BCL	*	16.79	1XE.NCL		37.88
1 x 1/2	50	50	71	1XD.BCL	*	14.90	1XD.NCL		35.86
1-1/4 x 1/2	25	25	100	1BXD.BCL	*	23.70	1BXD.NCL		58.80
1-1/4 x 3/4	25	25	115	1BXE.BCL	*	24.09	1BXE.NCL		48.38
1-1/4 x 1	25	25	127	1BX1.BCL	*	21.14	1BX1.NCL		55.58
1-1/2 x 1/2	25	25	147	1DXD.BCL	*	41.86	1DXD.NCL		86.28
1-1/2 x 3/4	25	25	146	1DXE.BCL	*	39.02	1DXE.NCL		70.86
1-1/2 x 1	25	25	157	1DX1.BCL	*	39.02	1DX1.NCL		81.42
1-1/2 x 1-1/4	25	25	190	1DX1B.BCL	*	42.69	1DX1B.NCL		83.07
2 x 1/2	15	15	204	2XD.BCL	*	65.07	2XD.NCL		122.18
2 x 3/4	15	15	206	2XE.BCL	*	57.11	2XE.NCL		122.18
2 x 1	15	15	227	2X1.BCL	*	57.11	2X1.NCL		122.18
2 x 1-1/4	15	15	249	2X1B.BCL	*	61.08	2X1B.NCL		122.18
2 x 1-1/2	15	15	274	2X1D.BCL	*	57.11	2X1D.NCL		100.32
2-1/2 x 3/4	10	10	280	2DXE.BCL		130.38	2DXE.NCL		234.22
2-1/2 x 1	10	10	258	2DX1.BCL		133.21	2DX1.NCL		234.22
2-1/2 x 1-1/4	10	10	326	2DX1B.BCL		133.21	2DX1B.NCL		234.22
2-1/2 x 1-1/2	10	10	326	2DX1D.BCL		130.07	2DX1D.NCL		220.96
2-1/2 x 2	10	10	400	2DX2.BCL		115.35	2DX2.NCL		220.96
3 x 1	6	6	475	3X1.BCL		213.27	3X1.NCL		536.34
3 x 1-1/4	6	6	465	3X1B.BCL		217.77	3X1B.NCL		310.76
3 x 1-1/2	6	6	603	3X1D.BCL		217.77	3X1D.NCL		378.46
3 x 2	6	6	575	3X2.BCL		200.62	3X2.NCL		357.03
3 x 2-1/2	6	6	574	3X2D.BCL		217.77	3X2D.NCL		378.46
4 x 1-1/2	4	4	850	4X1D.BCL		363.80	4X1D.NCL		653.19
4 x 2	4	4	775	4X2.BCL		371.56	4X2.NCL		616.22
4 x 2-1/2	4	4	890	4X2D.BCL		371.56	4X2D.NCL		653.19
4 x 3	4	4	1067	4X3.BCL		371.56	4X3.NCL		616.22
5 x 4	1	1	1690	5X4.BCL		855.09			
6 x 3	1	1	2038	6X3.BCL		1132.32			
6 x 4	1	1	2465	6X4.BCL		1132.32			



**CAST IRON  
45° ELBOWS  
CLASS 125**

Fig. 23

DESCRIPTION	PCS PER BOX	PCS PER MASTER	WEIGHT PER 100	PART # BLACK	PRICE (US\$) BLACK	PART # GALV.	PRICE (US\$) GALV.
1/4	1	1	16	B.BC45L			
3/8	1	1	25	C.BC45L			
1/2	100	100	36	D.BC45L	*	D.NC45L	28.78
3/4	100	100	60	E.BC45L	*	E.NC45L	33.01
1	50	50	87	1.BC45L	*	1.NC45L	40.59
1-1/4	25	25	140	1B.BC45L	*	1B.NC45L	60.59
1-1/2	25	25	180	1D.BC45L	*	1D.NC45L	85.66
2	15	15	316	2.BC45L	*	2.NC45L	120.12
2-1/2	10	10	462	2D.BC45L		2D.NC45L	193.64
3	6	6	655	3.BC45L		3.NC45L	377.72
4	2	2	992	4.BC45L		4.NC45L	692.57
6	1	1	2530	6.BC45L			

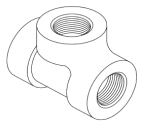

**CAST IRON  
STRAIGHT TEES  
CLASS 125**

Fig. 24

DESCRIPTION	PCS PER BOX	PCS PER MASTER	WEIGHT PER 100	PART # BLACK	PRICE (US\$) BLACK	PART # GALV.	PRICE (US\$) GALV.
1/4	1	1	22	B.BCT		B.NCT	26.51
3/8	25	150	38	C.BCT	*	C.NCT	30.45
1/2	100	100	55	D.BCT	*	D.NCT	29.39
3/4	50	50	92	E.BCT	*	E.NCT	40.66
1	25	25	142	1.BCT	*	1.NCT	44.15
1-1/4	25	25	223	1B.BCT	*	1B.NCT	77.24
1-1/2	25	25	287	1D.BCT	*	1D.NCT	102.17
2	15	15	469	2.BCT	*	2.NCT	127.48
2-1/2	9	9	675	2D.BCT		2D.NCT	259.13
3	5	5	994	3.BCT		3.NCT	583.29
3-1/2	3	3	1246	3D.BCT		3D.NCT	729.30
4	2	2	1737	4.BCT		4.NCT	817.22
5	1	1	2718	5.BCT			
6	1	1	3960	6.BCT			

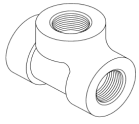

Fig. 25

**CAST IRON  
REDUCING TEES  
CLASS 125**

DESCRIPTION	PCS PER BOX	PCS PER MASTER	WEIGHT PER 100	PART # BLACK	PRICE (US\$) BLACK	PART # GALV.	PRICE (US\$) GALV.
1/2 x 1/2 x 1/4	1	1	60	DXB.BCT	36.77		
1/2 x 1/2 x 3/8	25	25	55	DXC.BCT	30.98	DXC.NCT	43.76
1/2 x 1/2 x 3/4	50	50	99	DXE.BCT	* 28.05	DXE.NCT	46.53
1/2 x 1/2 x 1	45	45	89	DXI.BCT	* 33.20		
3/4 x 1/2 x 1/2	50	50	66	EXDXD.BCT	* 28.05	EXDXD.NCT	43.92
3/4 x 1/2 x 3/4	50	50	96	EXDXE.BCT	* 28.05	EXDXE.NCT	43.92
3/4 x 3/4 x 1/4	1	1	62	EXB.BCT	31.92		
3/4 x 3/4 x 3/8	50	50	81	EXC.BCT	28.77	EXC.NCT	46.53
3/4 x 3/4 x 1/2	50	50	81	EXD.BCT	* 24.16	EXD.NCT	43.92
3/4 x 3/4 x 1	45	45	135	EXI.BCT	* 28.37	EXI.NCT	57.36
1 x 1/4 x 1	50	50	106	1XB1.BCT	36.27	1XB1.NCT	57.36
1 x 1/2 x 1/2	50	50	84	1XDXD.BCT	34.82	1XDXD.NCT	47.10
1 x 1/2 x 3/4	50	50	100	1DXDE.BCT	31.74	1DXDE.NCT	52.67
1 x 1/2 x 1	50	50	109	1DXI.BCT	* 22.98	1DXI.NCT	48.90
1 x 1/2 x 1-1/4	25	25	187	1DX1B.BCT	65.17	1DX1B.NCT	86.64
1 x 3/4 x 1/2	50	50	97	1XEXD.BCT	31.74	1XEXD.NCT	52.67
1 x 3/4 x 3/4	50	50	100	1XEXE.BCT	* 29.13	1XEXE.NCT	49.69
1 x 3/4 x 1	50	50	126	1XEX1.BCT	* 23.34	1XEX1.NCT	42.40
1 x 3/4 x 1-1/4	25	25	202	1XEX1B.BCT	65.17	1XEX1B.NCT	86.64
1 x 1 x 1/4	1	1	85	1XB.BCT	35.94		
1 x 1 x 3/8	50	50	116	1XC.BCT	28.27	1XC.NCT	53.35
1 x 1 x 1/2	50	50	108	1XD.BCT	* 17.43	1XD.NCT	53.35
1 x 1 x 3/4	50	50	126	1XE.BCT	* 20.92	1XE.NCT	51.63
1 x 1 x 1-1/4	25	25	164	1X1B.BCT	* 33.44	1X1B.NCT	84.96
1 x 1 x 1-1/2	25	25	194	1X1D.BCT	55.93	1X1D.NCT	73.68
1 x 1 x 2	1	1	225	1X2.BCT	105.76		
1-1/4 x 1/2 x 1-1/4	25	25	181	1BXDX1B.BCT	* 43.11	1BXDX1B.NCT	81.74
1-1/4 x 1/2 x 1-1/2	25	25	230	1BXDX1D.BCT	60.55	1BXDX1D.NCT	117.68
1-1/4 x 1/2 x 1	25	25	185	1BXDX1.BCT	* 50.60	1BXDX1.NCT	81.74
1-1/4 x 1/2 x 3/4	25	25	144	1BXDXE.BCT	50.69	1BXDXE.NCT	86.64
1-1/4 x 1/2 x 1/2	25	25	110	1BXDXD.BCT	66.53	1BXDXD.NCT	86.64
1-1/4 x 3/4 x 1/2	25	25	150	1BXEXD.BCT	50.39	1BXEXD.NCT	86.64
1-1/4 x 3/4 x 3/4	25	25	136	1BXEXE.BCT	* 50.39	1BXEXE.NCT	86.64
1-1/4 x 3/4 x 1	25	25	172	1BXEX1.BCT	* 50.39	1BXEX1.NCT	86.64
1-1/4 x 3/4 x 1-1/4	25	25	177	1BXEX1B.BCT	* 41.12	1BXEX1B.NCT	75.76
1-1/4 x 3/4 x 1-1/2	25	25	230	1BXEX1D.BCT	54.76	1BXEX1D.NCT	125.39
1-1/4 x 1 x 1/2	25	25	136	1BX1XD.BCT	* 28.25	1BX1XD.NCT	80.28
1-1/4 x 1 x 3/4	25	25	160	1BX1XE.BCT	* 31.94	1BX1XE.NCT	84.96
1-1/4 x 1 x 1	25	25	164	1BX1X1.BCT	* 27.89	1BX1X1.NCT	80.28
1-1/4 x 1 x 1-1/4	25	25	195	1BX1X1B.BCT	* 30.80	1BX1X1B.NCT	84.96
1-1/4 x 1 x 1-1/2	25	25	270	1BX1X1D.BCT	* 51.73	1BX1X1D.NCT	120.71
1-1/4 x 1 x 2	1	1	267	1BX1X2.BCT	98.39		
1-1/4 x 1-1/4 x 1/2	25	25	164	1BXD.BCT	* 27.86	1BXD.NCT	80.28
1-1/4 x 1-1/4 x 3/4	25	25	165	1BXE.BCT	* 30.26	1BXE.NCT	65.93
1-1/4 x 1-1/4 x 1	25	25	185	1BXI.BCT	* 27.89	1BXI.NCT	80.28
1-1/4 x 1-1/4 x 1-1/2	25	25	278	1BX1D.BCT	* 51.73	1BX1D.NCT	120.71
1-1/4 x 1-1/4 x 2	1	1	290	1BX2.BCT	82.62		
1-1/2 x 1/2 x 1/2	25	25	158	1DXDXD.BCT	65.92	1DXDXD.NCT	117.45
1-1/2 x 1/2 x 3/4	25	25	167	1DXDXE.BCT	65.92	1DXDXE.NCT	117.45
1-1/2 x 1/2 x 1-1/4	25	25	235	1DXDX1B.BCT	* 65.53	1DXDX1B.NCT	117.68
1-1/2 x 1/2 x 1-1/2	25	25	217	1DXDX1D.BCT	* 57.67	1DXDX1D.NCT	117.68
1-1/2 x 3/4 x 1/2	25	25	171	1DXEXD.BCT	56.65	1DXEXD.NCT	121.33
1-1/2 x 3/4 x 3/4	25	25	166	1DXEXE.BCT	56.65	1DXEXE.NCT	121.33
1-1/2 x 3/4 x 1	25	25	192	1DXEX1.BCT	56.65	1DXEX1.NCT	99.62
1-1/2 x 3/4 x 1-1/4	25	25	230	1DXEX1B.BCT	* 56.35	1DXEX1B.NCT	121.33
1-1/2 x 3/4 x 1-1/2	25	25	228	1DXEX1D.BCT	* 56.33	1DXEX1D.NCT	96.63
1-1/2 x 1 x 2	15	15	411	1DX1X2.BCT	* 80.80	1DX1X2.NCT	160.75
1-1/2 x 1-1/4 x 1/2	25	25	178	1DX1BXD.BCT	* 39.28	1DX1BXD.NCT	109.20
1-1/2 x 1-1/4 x 3/4	25	25	204	1DX1BXE.BCT	* 41.55	1DX1BXE.NCT	115.49
1-1/2 x 1-1/4 x 1	25	25	218	1DX1BX1.BCT	* 36.37	1DX1BX1.NCT	109.20
1-1/2 x 1-1/4 x 1-1/4	25	25	236	1DX1BX1B.BCT	* 51.73	1DX1BX1B.NCT	120.71
1-1/2 x 1-1/4 x 1-1/2	25	25	271	1DX1BX1D.BCT	* 51.73	1DX1BX1D.NCT	120.71
1-1/2 x 1-1/4 x 2	15	15	430	1DX1BX2.BCT	* 79.17	1DX1BX2.NCT	157.73
1-1/2 x 1-1/2 x 1/2	25	25	200	1DXD.BCT	* 36.37	1DXD.NCT	109.20
1-1/2 x 1-1/2 x 3/4	25	25	217	1DXE.BCT	* 39.28	1DXE.NCT	109.20
1-1/2 x 1-1/2 x 1	25	25	242	1DXI.BCT	* 36.37	1DXI.NCT	109.20



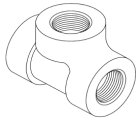

Fig. 25

**CAST IRON  
REDUCING TEES  
CLASS 125**  
(continued)

1-1/2 X 1-1/2 X 1-1/4	25	25	262	1DX1B.BCT *	51.73	1DX1B.NCT	120.71
1-1/2 x 1-1/2 x 2	15	15	355	1DX2.BCT *	56.57	1DX2.NCT	157.73
1-1/2 x 1-1/2 x 2-1/2	10	10	425	1DX2D.BCT *	174.51	1DX2D.NCT	305.78
2 x 1/2 x 1/2	15	15	220	2DXD.BCT	93.00		
2 x 1/2 x 1-1/4	15	15	341	2DXD1B.BCT *	93.00	2DXD1B.NCT	151.64
2 x 1/2 x 1-1/2	15	15	314	2DXD1D.BCT *	93.00	2DXD1D.NCT	160.75
2 x 1/2 x 2	15	15	330	2DXD2.BCT *	80.80	2DXD2.NCT	151.64
2 x 3/4 x 1	15	15	250	2XEX1.BCT	93.00	2XEX1.NCT	160.75
2 x 3/4 x 1-1/4	15	15	424	2XEX1B.BCT	93.00	2XEX1B.NCT	160.75
2 x 3/4 x 1-1/2	15	15	410	2XEX1D.BCT *	93.00	2XEX1D.NCT	151.64
2 x 3/4 x 2	15	15	380	2XEX2.BCT *	73.83	2XEX2.NCT	157.23
2 x 3/4 x 2-1/2	10	10	360	2XEX2D.BCT	174.49	2XEX2D.NCT	305.78
2 x 1 x 3/4	15	15	250	2X1XE.BCT *	90.81	2X1XE.NCT	160.75
2 x 1 x 1	15	15	240	2X1X1.BCT *	90.80	2X1X1.NCT	151.64
2 x 1 x 1-1/4	15	15	300	2X1X1B.BCT	93.00	2X1X1B.NCT	160.75
2 x 1 x 1-1/2	15	15	413	2X1X1D.BCT *	75.55	2X1X1D.NCT	160.75
2 x 1 x 2	15	15	370	2X1X2.BCT *	81.45	2X1X2.NCT	149.12
2 x 1 x 2-1/2	10	10	560	2X1X2D.BCT	174.51	2X1X2D.NCT	305.78
2 x 1-1/4 x 1/2	15	15	244	2X1BXD.BCT	93.00	2X1BXD.NCT	151.64
2 x 1-1/4 x 3/4	1	1	250	2X1BXE.BCT	105.76		
2 x 1-1/4 x 1	15	15	310	2X1BX1.BCT *	90.80	2X1BX1.NCT	160.75
2 x 1-1/4 x 1-1/4	15	15	300	2X1BX1B.BCT *	80.80	2X1BX1B.NCT	131.99
2 x 1-1/4 x 1-1/2	15	15	363	2X1BX1D.BCT *	93.00	2X1BX1D.NCT	160.75
2 x 1-1/4 x 2	15	15	396	2X1BX2.BCT *	70.29	2X1BX2.NCT	133.98
2 x 1-1/4 x 2-1/2	10	10	556	2X1BX2D.BCT	174.51	2X1BX2D.NCT	305.78
2 x 1-1/2 x 1/2	15	15	239	2X1DXD.BCT *	59.00	2X1DXD.NCT	149.12
2 x 1-1/2 x 3/4	15	15	273	2X1DXE.BCT *	59.00	2X1DXE.NCT	149.12
2 x 1-1/2 x 1	15	15	289	2X1DX1.BCT *	51.55	2X1DX1.NCT	149.12
2 x 1-1/2 x 1-1/4	15	15	363	2X1DX1B.BCT *	80.73	2X1DX1B.NCT	132.61
2 x 1-1/2 x 1-1/2	15	15	346	2X1DX1D.BCT *	79.17	2X1DX1D.NCT	155.04
2 x 1-1/2 x 2	15	15	400	2X1DX2.BCT *	70.29	2X1DX2.NCT	127.31
2 x 1-1/2 x 2-1/2	10	10	628	2X1DX2D.BCT	150.63	2X1DX2D.NCT	305.78
2 x 2 x 1/2	15	15	290	2XD.BCT *	51.55	2XD.NCT	149.12
2 x 2 x 3/4	15	15	310	2XE.BCT *	51.55	2XE.NCT	149.12
2 x 2 x 1	15	15	326	2X1.BCT *	51.55	2X1.NCT	149.12
2 x 2 x 1-1/4	15	15	364	2X1B.BCT *	57.89	2X1B.NCT	149.12
2 x 2 x 1-1/2	15	15	396	2X1D.BCT *	61.18	2X1D.NCT	157.73
2 x 2 x 2-1/2	10	10	550	2X2D.BCT *	131.23	2X2D.NCT	244.16
2 x 2 x 3	6	6	922	2X3.BCT	236.63	2X3.NCT	460.94
2-1/2 x 1/2 x 2-1/2	10	10	549	2DXDX2D.BCT	157.56	2DXDX2D.NCT	294.71
2-1/2 x 3/4 x 2	10	10	440	2DXEX2.BCT	153.95	2DXEX2.NCT	299.99
2-1/2 x 3/4 x 2-1/2	10	10	532	2DXEX2D.BCT	153.95	2DXEX2D.NCT	294.71
2-1/2 x 1 x 3/4	10	10	280	2DX1XE.BCT	174.49		
2-1/2 x 1 x 1	10	10	315	2DX1X1.BCT	174.49		
2-1/2 x 1 x 1-1/4	10	10	388	2DX1X1B.BCT	174.49	2DX1X1B.NCT	299.99
2-1/2 x 1 x 2	10	10	470	2DX1X2.BCT	174.51	2DX1X2.NCT	299.99
2-1/2 x 1 x 2-1/2	10	10	525	2DX1X2D.BCT	154.07	2DX1X2D.NCT	299.99
2-1/2 x 1-1/4 x 1	10	10	394	2DX1BX1.BCT	174.49	2DX1BX1.NCT	319.45
2-1/2 x 1-1/4 x 1-1/4	10	10	380	2DX1BX1B.BCT	174.49	2DX1BX1B.NCT	319.45
2-1/2 x 1-1/4 x 2	10	10	557	2DX1BX2.BCT	174.51	2DX1BX2.NCT	246.31
2-1/2 x 1-1/4 x 2-1/2	10	10	520	2DX1BX2D.BCT	174.51	2DX1BX2D.NCT	246.31
2-1/2 x 1-1/2 x 1/2	10	10	376	2DX1DXD.BCT	164.62	2DX1DXD.NCT	319.45
2-1/2 x 1-1/2 x 1-1/4	10	10	446	2DX1DX1B.BCT	174.49	2DX1DX1B.NCT	319.45
2-1/2 x 1-1/2 x 1-1/2	10	10	601	2DX1DX1D.BCT	174.51	2DX1DX1D.NCT	251.06
2-1/2 x 1-1/2 x 2	10	10	558	2DX1DX2.BCT	174.51	2DX1DX2.NCT	305.78
2-1/2 x 1-1/2 x 2-1/2	10	10	535	2DX1DX2D.BCT	174.51	2DX1DX2D.NCT	305.78
2-1/2 x 2 x 1/2	10	10	350	2DX2XD.BCT	174.51	2DX2XD.NCT	305.78
2-1/2 x 2 x 3/4	10	10	433	2DX2XE.BCT	147.57	2DX2XE.NCT	246.31
2-1/2 x 2 x 1	10	10	440	2DX2X1.BCT	150.50	2DX2X1.NCT	305.78
2-1/2 x 2 x 1-1/4	10	10	412	2DX2X1B.BCT	174.51	2DX2X1B.NCT	288.46
2-1/2 x 2 x 1-1/2	10	10	574	2DX2X1D.BCT	167.28	2DX2X1D.NCT	251.06
2-1/2 x 2 x 2	10	10	537	2DX2X2.BCT	154.07	2DX2X2.NCT	288.46
2-1/2 x 2 x 2-1/2	10	10	575	2DX2X2D.BCT	151.17	2DX2X2D.NCT	299.99
2-1/2 x 2 x 3	6	6	888	2DX2X3.BCT	262.25	2DX2X3.NCT	378.47
2-1/2 x 2-1/2 x 1/2	10	10	490	2DXD.BCT	167.28	2DXD.NCT	305.78
2-1/2 x 2-1/2 x 3/4	10	10	475	2DXE.BCT	150.50	2DXE.NCT	288.46
2-1/2 x 2-1/2 x 1	10	10	469	2DX1.BCT	147.57	2DX1.NCT	283.02
2-1/2 x 2-1/2 x 1-1/4	10	10	450	2DX1B.BCT	150.50	2DX1B.NCT	288.46

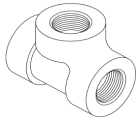
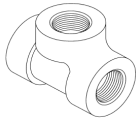

Fig. 25

**CAST IRON  
REDUCING TEES  
CLASS 125  
(continued)**

2-1/2 x 2-1/2 x 1-1/2	10	10	500	2DX1D.BCT	154.07	2DX1D.NCT	305.78
2-1/2 x 2-1/2 x 2	10	10	610	2DX2.BCT	150.50	2DX2.NCT	288.46
2-1/2 x 2-1/2 x 3	6	6	958	2DX3.BCT	262.25	2DX3.NCT	484.10
3 x 1 x 2	6	6	580	3X1X2.BCT	262.25		
3 x 1 x 3	6	6	822	3X1X3.BCT	262.25	3X1X3.NCT	460.94
3 x 1-1/4 x 3	6	6	838	3X1BX3.BCT	262.25	3X1BX3.NCT	460.94
3 x 1-1/2 x 1-1/2	6	6	675	3X1DX1D.BCT	262.29	3X1DX1D.NCT	397.50
3 x 1-1/2 x 2	6	6	650	3X1DX2.BCT	262.29	3X1DX2.NCT	484.10
3 x 1-1/2 x 3	6	6	830	3X1DX3.BCT	262.25	3X1DX3.NCT	460.94
3 x 2 x 1-1/2	6	6	650	3X2X1D.BCT	262.25	3X2X1D.NCT	460.94
3 x 2 x 2	6	6	615	3X2X2.BCT	262.25	3X2X2.NCT	434.84
3 x 2 x 2-1/2	6	6	850	3X2X2D.BCT	249.94	3X2X2D.NCT	456.72
3 x 2 x 3	6	6	780	3X2X3.BCT	262.25	3X2X3.NCT	460.94
3 x 2-1/2 x 1-1/4	6	6	658	3X2DX1B.BCT	249.94	3X2DX1B.NCT	456.72
3 x 2-1/2 x 1-1/2	1	1	623	3X2DX1D.BCT	355.21		
3 x 2-1/2 x 2	6	6	837	3X2DX2.BCT	262.25	3X2DX2.NCT	434.84
3 x 2-1/2 x 2-1/2	6	6	780	3X2DX2D.BCT	262.25	3X2DX2D.NCT	434.84
3 x 2-1/2 x 3	6	6	850	3X2DX3.BCT	262.25	3X2DX3.NCT	460.94
3 x 3 x 1/2	1	1	608	3XD.BCT	355.21		
3 x 3 x 3/4	1	1	595	3XE.BCT	355.21		
3 x 3 x 1	6	6	660	3X1.BCT	220.89	3X1.NCT	378.47
3 x 3 x 1-1/4	6	6	584	3X1B.BCT	241.66	3X1B.NCT	378.47
3 x 3 x 1-1/2	6	6	840	3X1D.BCT	262.25	3X1D.NCT	378.47
3 x 3 x 2	6	6	800	3X2.BCT	225.57	3X2.NCT	434.84
3 x 3 x 2-1/2	6	6	775	3X2D.BCT	262.25	3X2D.NCT	434.84
3 x 3 x 4	1	1	1280	3X4.BCT	643.99		
4 x 1 x 4	4	4	1392	4X1X4.BCT	454.86	4X1X4.NCT	921.78
4 x 1-1/2 x 4	4	4	1325	4X1DX4.BCT	498.96	4X1DX4.NCT	921.78
4 x 2 x 2	4	4	875	4X2X2.BCT	536.40	4X2X2.NCT	921.78
4 x 2 x 4	4	4	1360	4X2X4.BCT	523.62	4X2X4.NCT	921.78
4 x 2-1/2 x 2-1/2	4	4	1083	4X2DX2D.BCT	641.55	4X2DX2D.NCT	869.59
4 x 2-1/2 x 4	4	4	1400	4X2DX4.BCT	523.62	4X2DX4.NCT	869.59
4 x 3 x 1-1/2	4	4	1058	4X3X1D.BCT	536.40	4X3X1D.NCT	921.78
4 x 3 x 2	4	4	1200	4X3X2.BCT	536.40	4X3X2.NCT	921.78
4 x 3 x 2-1/2	4	4	1270	4X3X2D.BCT	498.96	4X3X2D.NCT	921.78
4 x 3 x 3	4	4	1160	4X3X3.BCT	689.63	4X3X3.NCT	921.78
4 x 3 x 4	4	4	1500	4X3X4.BCT	523.62	4X3X4.NCT	869.59
4 x 3-1/2 x 4	2	2	1805	4X3DX4.BCT	526.87	4X3DX4.NCT	1097.23
4 x 4 x 3/4	1	1	1058	4XE.BCT	709.13		
4 x 4 x 1	1	1	980	4X1.BCT	653.39		
4 x 4 x 1-1/4	1	1	978	4X1B.BCT	590.06		
4 x 4 x 1-1/2	4	4	1108	4X1D.BCT	523.62	4X1D.NCT	869.59
4 x 4 x 2	4	4	1117	4X2.BCT	461.85	4X2.NCT	921.78
4 x 4 x 2-1/2	4	4	1238	4X2D.BCT	482.53	4X2D.NCT	869.59
4 x 4 x 3	4	4	1410	4X3.BCT	511.47	4X3.NCT	921.78
5 x 5 x 3	1	1	2000	5X3.BCT	1216.65		
5 x 5 x 4	1	1	2383	5X4.BCT	1180.96		
6 x 6 x 3	1	1	2670	6X3.BCT	1518.25		
6 x 6 x 4	1	1	3043	6X4.BCT	1564.04		
6 x 6 x 5	1	1	3523	6X5.BCT	1518.25		
4 x 2-1/2 x 2-1/2	4	4	1083	4X2DX2D.BCT	641.55	4X2DX2D.NCT	869.59
4 x 2 x 2	4	4	875	4X2X2.BCT	536.40	4X2X2.NCT	921.78
5 x 5 x 3	1	1	2000	5X3.BCT	1216.65		
5 x 5 x 4	1	1	2383	5X4.BCT	1180.96		
6 x 6 x 3	1	1	2670	6X3.BCT	1518.25		
6 x 6 x 4	1	1	3043	6X4.BCT	1564.04		
6 x 6 x 5	1	1	3523	6X5.BCT	1518.25		



**CAST IRON  
REDUCING TEES  
CLASS 250**

DESCRIPTION	PCS PER BOX	PCS PER MASTER	WEIGHT PER 100	PART # BLACK	PRICE (US\$) BLACK	PART # GALV.	PRICE (US\$) GALV.
1-1/4 x 1-1/4 x 3/4	1	1	321	1BXE.BC250T	186.74		
1-1/2 x 1-1/2 x 3/4	1	1	402	1DXE.BC250T	277.35		
2 x 2 x 3/4	1	1	615	2XE.BC250T	305.92		
2 x 2 x 1-1/2	1	1	760	2X1D.BC250T	377.13		



Fig. 30A

**CAST IRON  
CROSSES  
CLASS 125**

DESCRIPTION	PCS PER BOX	PCS PER MASTER	WEIGHT PER 100	PART # BLACK	PRICE (US\$) BLACK	PART # GALV.	PRICE (US\$) GALV.
1/2	50	50	87	D.BCCR	41.05	D.NCCR	71.44
3/4	30	30	130	E.BCCR	41.05	E.NCCR	58.66
1	25	25	178	1.BCCR	47.82	1.NCCR	99.53
1-1/4	15	15	295	1B.BCCR	67.45	1B.NCCR	109.85
1-1/4 x 1	15	15	215	1BX1.BCCR	77.52	1BX1.NCCR	139.96
1-1/2	10	10	350	1D.BCCR	93.60	1D.NCCR	168.76
1-1/2 x 1-1/4	1	1	280	1DX1B.BCCR	110.94		
1-1/2 x 1-1/4 x 1	1	1	303	1DX1BX1.BCCR	152.66		
1-1/2 x 1-1/4 x 1 x 1	1	1	268	1DX1BX1X1.BCCR	110.94		
1-1/2 x 1	10	10	262	1DX1.BCCR	92.19	1DX1.NCCR	170.41
1-1/2 x 1 x 1 x 1	12	12	259	1DX1X1X1.BCCR	128.82		
2	8	8	650	2.BCCR	123.95	2.NCCR	265.19
2 x 1	8	8	352	2X1.BCCR	126.21	2X1.NCCR	265.57
2 x 1-1/4	1	1	373	2X1B.BCCR	142.16		
2 x 1-1/2	1	1	410	2X1D.BCCR	127.34		
2 x 1-1/2 x 1 x 1	1	1	367	2X1DX1X1.BCCR	191.39		
4	1	1	1950	4.BCCR	913.95		

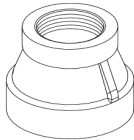

Fig. 29

**CAST IRON  
REDUCING  
COUPLINGS  
CLASS 125**

DESCRIPTION	PCS PER BOX	PCS PER MASTER	WEIGHT PER 100	PART # BLACK	PRICE (US\$) BLACK	PART # GALV.	PRICE (US\$) GALV.
3/4 x 1/2	50	50	44	EXD.BR	26.72	EXD.NR	36.07
1 x 1/2	50	50	58	1XD.BR	13.67	1XD.NR	42.87
1 x 3/4	50	50	64	1XE.BR	18.12	1XE.NR	51.41
1-1/4 x 1/2	50	50	96	1BXD.BR	53.99		
1-1/4 x 3/4	50	50	99	1BXE.BR	40.13	1BXE.NR	86.49
1-1/4 x 1	50	50	105	1BX1.BR	46.95	1BX1.NR	87.94
1-1/2 x 1/2	1	1	105	1DXD.BR	84.81		
1-1/2 x 3/4	40	40	127	1DXE.BR	76.32	1DXE.NR	256.49
1-1/2 x 1	40	40	150	1DX1.BR	66.45	1DX1.NR	130.00
1-1/2 x 1-1/4	40	40	135	1DX1B.BR	66.45	1DX1B.NR	130.00
2 x 1/2	30	30	175	2XD.BR	96.48	2XD.NR	170.14
2 x 3/4	30	30	172	2XE.BR	86.91	2XE.NR	170.14
2 x 1	30	30	172	2X1.BR	77.38	2X1.NR	176.97
2 x 1-1/4	30	30	204	2X1B.BR	90.80	2X1B.NR	180.34
2 x 1-1/2	30	30	209	2X1D.BR	86.91	2X1D.NR	148.07
2-1/2 x 1-1/2	18	18	325	2DX1D.BR	137.34	2DX1D.NR	226.49
2-1/2 x 2	18	18	300	2DX2.BR	123.51	2DX2.NR	197.12
3 x 1-1/2	12	12	458	3X1D.BR	209.65	3X1D.NR	255.82
3 x 2	12	12	435	3X2.BR	151.38	3X2.NR	244.97
3 x 2-1/2	1	1	440	3X2D.BR	195.89		
4 x 2	1	1	605	4X2.BR	401.50		
4 x 2-1/2	1	1	780	4X2D.BR	401.50		
4 x 3	1	1	700	4X3.BR	401.50		
6 x 4	1	1	1335	6X4.BR	727.74		

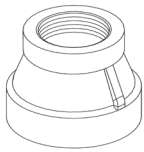

Fig. 29E

**CAST IRON  
ECCENTRIC  
REDUCERS  
CLASS 125**

DESCRIPTION	PCS PER BOX	PCS PER MASTER	WEIGHT PER 100	PART # BLACK	PRICE (US\$) BLACK	PART # GALV.	PRICE (US\$) GALV.
3/4 x 1/2	50	50	45	EXD.BER	56.23	EXD.NER	101.23
1 x 1/2	50	50	64	1XD.BER	59.03	1XD.NER	116.89
1 x 3/4	50	50	69	1XE.BER	60.73	1XE.NER	109.31
1-1/4 x 1/2	50	50	91	1BXD.BER	97.01	1BXD.NER	174.65
1-1/4 x 3/4	50	50	96	1BXE.BER	87.91	1BXE.NER	158.23
1-1/4 x 1	50	50	89	1BX1.BER	90.45	1BX1.NER	162.82
1-1/2 x 1/2	40	40	117	1DXD.BER	122.14	1DXD.NER	244.30
1-1/2 x 3/4	40	40	110	1DXE.BER	128.25	1DXE.NER	230.86
1-1/2 x 1	40	40	127	1DX1.BER	128.25	1DX1.NER	230.86
1-1/2 x 1-1/4	40	40	141	1DX1B.BER	122.63	1DX1B.NER	220.71
2 x 1/2	1	1	183	2XD.BER	163.93		
2 x 3/4	25	25	185	2XE.BER	184.79	2XE.NER	369.57
2 x 1	30	30	195	2X1.BER	167.41	2X1.NER	293.73
2 x 1-1/4	30	30	205	2X1B.BER	159.41	2X1B.NER	286.95
2 x 1-1/2	30	30	198	2X1D.BER	162.61	2X1D.NER	292.72
2-1/2 x 1	1	1	258	2DX1.BER	254.24		
2-1/2 x 1-1/4	1	1	265	2DX1B.BER	254.24		
2-1/2 x 1-1/2	12	12	265	2DX1D.BER	254.24		
2-1/2 x 2	10	10	308	2DX2.BER	248.32		
3 x 1	1	1	367	3X1.BER	401.50		
3 x 1-1/4	1	1	388	3X1B.BER	401.50		
3 x 1-1/2	1	1	383	3X1D.BER	342.06		
3 x 2	10	10	403	3X2.BER	307.87		
3 x 2-1/2	1	1	468	3X2D.BER	369.98		
4 x 1-1/4	1	1	658	4X1B.BER	724.36		
4 x 1-1/2	1	1	661	4X1D.BER	673.83		
4 x 2	1	1	600	4X2.BER	724.36		

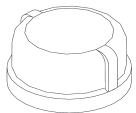

Fig. 30

**CAST IRON  
PIPE CAPS  
CLASS 125**

DESCRIPTION	PCS PER BOX	PCS PER MASTER	WEIGHT PER 100	PART # BLACK	PRICE (US\$) BLACK	PART # GALV.	PRICE (US\$) GALV.
2-1/2	6	6	225	2D.BCCAP	81.87	2D.NCCAP	141.12
3	6	6	375	3.BCCAP	107.72	3.NCCAP	179.47
4	5	5	600	4.BCCAP	154.94	4.NCCAP	290.09
5	6	6	1014	5.BCCAP	235.90	5.NCCAP	455.30
6	3	3	1910	6.BCCAP	295.58	6.NCCAP	1170.89
8	1	1	2825	8.BCCAP	837.92	8.NCCAP	1638.10

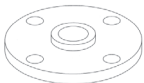

Fig. 20

**COMPANION  
FLANGES  
THREADED  
CLASS 125**

DESCRIPTION	PCS PER BOX	PCS PER MASTER	WEIGHT PER 100	PART # BLACK	PRICE (US\$) BLACK	PART # GALV.	PRICE (US\$) GALV.
1x4-1/4	10	10	166	1X4B.BCF	73.36	1X4B.NCF	166.07
1-1/4x4-5/8	10	10	205	1B.BCF	87.78	1B.NCF	190.65
1-1/2x5	10	10	261	1DX5.BCF	81.12	1DX5.NCF	195.05
2x6	6	6	444	2X6.BCF	80.95	2X6.NCF	171.53
2-1/2x7	6	6	607	2DX7.BCF	94.71	2DX7.NCF	200.67
3x7-1/2	5	5	764	3X7D.BCF	122.00	3X7D.NCF	243.85
4x9	5	5	1188	4X9.BCF	164.41	4X9.NCF	332.13
5x10	1	1	1358	5X10.BCF	232.26	5X10.NCF	521.42
6x11	3	3	1745	6X11.BCF	262.77	6X11.NCF	557.33
8x13-1/2	1	1	3000	8X13D.BCF	414.78	8X13D.NCF	967.76
10x16	1	1	4200	10X16.BCF	735.10	10X16.NCF	1457.57

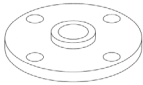

Fig. 71

**CAST IRON  
REDUCING  
FLANGES  
THREADED  
CLASS 125**

DESCRIPTION	PCS PER BOX	PCS PER MASTER	WEIGHT PER 100	PART # BLACK	PRICE (US\$) BLACK	PART # GALV.	PRICE (US\$) GALV.
3/4x5	10	10	300	EX5.BRF	212.05	EX5.NRF	345.57
1x5	10	10	300	1X5.BRF	216.81	1X5.NRF	345.57
1x6	6	6	450	1X6.BRF	206.66	1X6.NRF	330.05
1x7-1/2	5	5	810	1X7D.BRF	312.83	1X7D.NRF	501.90
1-1/4x6	6	6	400	1BX6.BRF	198.03	1BX6.NRF	334.84
1-1/4x7-1/2	5	5	800	1BX7D.BRF	312.83	1BX7D.NRF	483.76
1-1/2x6	6	6	425	1DX6.BRF	169.49	1DX6.NRF	334.84
1-1/2x7	6	6	637	1DX7.BRF	218.54	1DX7.NRF	341.64
1-1/2x7-1/2	5	5	825	1DX7D.BRF	262.01	1DX7D.NRF	518.80
1-1/2x9	5	5	1394	1DX9.BRF	387.01	1DX9.NRF	657.21
1-1/2x11	1	1	2410	1DX11.BRF	681.18	1DX11.NRF	1131.22
2x7	6	6	615	2X7.BRF	158.57	2X7.NRF	368.98
2x7-1/2	5	5	800	2X7D.BRF	211.42	2X7D.NRF	497.12
2x9	1	1	1403	2X9.BRF	287.36	2X9.NRF	696.48
2x10	1	1	1850	2X10.BRF	529.59	2X10.NRF	847.69
2x11	1	1	2450	2X11.BRF	525.52	2X11.NRF	1047.87
2x13-1/2	1	1	3080	2X13D.BRF	963.19	2X13D.NRF	1737.15
2-1/2x7-1/2	5	5	800	2DX7D.BRF	226.88	2DX7D.NRF	518.80
2-1/2x9	1	1	1450	2DX9.BRF	308.34	2DX9.NRF	657.21
2-1/2x10	1	1	1850	2DX10.BRF	529.59	2DX10.NRF	847.69
2-1/2x11	1	1	2225	2DX11.BRF	624.38	2DX11.NRF	1124.33
3x9	1	1	1313	3X9.BRF	287.36	3X9.NRF	696.48
3x10	1	1	1750	3X10.BRF	531.18	3X10.NRF	830.47
3x11	1	1	2200	3X11.BRF	525.52	3X11.NRF	1047.87
3x13-1/2	1	1	3900	3X13D.BRF	963.19	3X13D.NRF	1726.57
4x11	1	1	2012	4X11.BRF	433.39	4X11.NRF	1037.61
5x11	1	1	1900	5X11.BRF	549.28	5X11.NRF	1047.87
2x13-1/2	1	1	3080	2X13D.BRF	963.19	2X13D.NRF	1737.15
3x13-1/2	1	1	3900	3X13D.BRF	963.19	3X13D.NRF	1726.57
4x13-1/2	1	1	4056	4X13D.BRF	741.81	4X13D.NRF	1539.51
5x13-1/2	1	1	4000	5X13D.BRF	1041.15	5X13D.NRF	1572.47
6x13-1/2	1	1	3800	6X13D.BRF	672.45	6X13D.NRF	1654.63

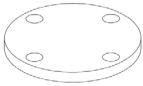

Fig. 19

**CAST IRON  
BLIND FLANGES  
CLASS 125**

DESCRIPTION	PCS PER BOX	PCS PER MASTER	WEIGHT PER 100	PART # BLACK	PRICE (US\$) BLACK	PART # GALV.	PRICE (US\$) GALV.
1 x 4-1/4	10	10	150	1X4B.BBF	116.77	1X4B.NBF	200.01
1-1/4 x 4-5/8	10	10	200	1B.BBF	123.37	1B.NBF	218.51
1-1/2 x 5	10	10	275	1DX5.BBF	130.97	1DX5.NBF	222.74
2 x 6	6	6	450	2X6.BBF	147.98	2X6.NBF	231.74
2-1/2 x 7	6	6	675	2DX7.BBF	162.64	2DX7.NBF	270.28
3 x 7-1/2	5	5	850	3X7D.BBF	194.92	3X7D.NBF	337.31
4 x 9	1	1	1456	4X9.BBF	249.67	4X9.NBF	472.10
5 x 10	1	1	2000	5X10.BBF	405.66	5X10.NBF	770.77
6 x 11	1	1	2475	6X11.BBF	441.31	6X11.NBF	818.26
8 x 13-1/2	1	1	3516	8X13D.BBF	692.40	8X13D.NBF	1081.75
10 x 16	1	1	6044	10X16.BBF	1024.32	10X16.NBF	1807.16

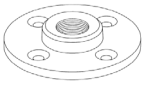

Fig. 15

**CAST IRON  
FLOOR FLANGES  
CLASS 125**

DESCRIPTION	PCS PER BOX	PCS PER MASTER	WEIGHT PER 100	PART # BLACK	PRICE (US\$) BLACK	PART # GALV.	PRICE (US\$) GALV.
3/8	25	150	36	C.BCFF	* 23.99	C.NCFF	46.66
1/2	30	120	46	D.BCFF	* 24.68	D.NCFF	61.62
3/4	30	120	48	E.BCFF	* 24.68	E.NCFF	61.62
1	30	60	87	1.BCFF	* 30.96	1.NCFF	56.23
1-1/4	30	60	80	1B.BCFF	* 30.96	1B.NCFF	74.74
1-1/2	20	40	137	1D.BCFF	* 39.87	1D.NCFF	95.79
2	15	30	215	2.BCFF	* 47.94	2.NCFF	121.60
3	10	10	225	3.BCFF	35.85		
4	10	10	450	4.BCFF	70.17		



Fig. 14

**CAST IRON  
FLANGES  
UNIONS  
CLASS 125**

DESCRIPTION	PCS PER BOX	PCS PER MASTER	WEIGHT PER 100	PART # BLACK	PRICE (US\$) BLACK	PART # GALV.	PRICE (US\$) GALV.
1/2	1	1	150	D.BFU	128.25	D.NFU	327.55
3/4	1	1	250	E.BFU	178.74	E.NFU	375.48
1	1	1	225	1.BFU	173.17	1.NFU	375.48
1-1/4	1	1	329	1B.BFU	204.82	1B.NFU	470.22
1-1/2	7	7	350	1D.BFU	189.02	1D.NFU	579.79
2	7	7	600	2.BFU	222.48	2.NFU	596.68
2-1/2	4	4	1000	2D.BFU	301.26	2D.NFU	898.12
3-1/2	4	4	1250	3D.BFU	578.17	3D.NFU	1547.28
3	4	4	1115	3.BFU	340.79	3.NFU	1190.68
4	3	3	1450	4.BFU	463.41	4.NFU	1579.68
5	2	2	2500	5.BFU	1080.07	5.NFU	1771.78
6	2	2	2850	6.BFU	1013.85	6.NFU	2024.36

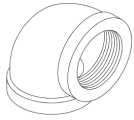

**CAST IRON  
90° ELBOWS  
CLASS 250**

DESCRIPTION	PCS PER BOX	PCS PER MASTER	WEIGHT PER 100	PART # BLACK	PRICE (US\$) BLACK	PART # GALV.	PRICE (US\$) GALV.
1/2	1	1	75	D.BC250L	49.23		
3/4	1	1	157	E.BC250L	50.12		
1	1	1	169	1.BC250L	60.61		
1-1/4	1	1	292	1B.BC250L	90.24		
1-1/2	1	1	386	1D.BC250L	111.95		
2	1	1	643	2.BC250L	138.14		
2-1/2	1	1	1056	2D.BC250L	335.33		

**CAST IRON  
45° ELBOWS  
CLASS 250**

DESCRIPTION	PCS PER BOX	PCS PER MASTER	WEIGHT PER 100	PART # BLACK	PRICE (US\$) BLACK	PART # GALV.	PRICE (US\$) GALV.
1/2	1	1	67	D.BC25045L	70.15		
3/4	1	1	104	E.BC25045L	67.73		
1	1	1	160	1.BC25045L	81.30		
1-1/4	1	1	270	1B.BC25045L	133.99		
1-1/2	1	1	355	1D.BC25045L	147.41		
2	1	1	617	2.BC25045L	209.65		
2-1/2	1	1	938	2D.BC25045L	362.00		

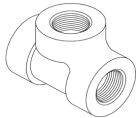

**CAST IRON  
STRAIGHT TEES  
CLASS 250**

DESCRIPTION	PCS PER BOX	PCS PER MASTER	WEIGHT PER 100	PART # BLACK	PRICE (US\$) BLACK	PART # GALV.	PRICE (US\$) GALV.
3/8	1	1	70	C.BC250T	80.21		
1/2	1	1	101	D.BC250T	76.90		
3/4	1	1	153	E.BC250T	76.84		
1	1	1	243	1.BC250T	92.77		
1-1/4	1	1	394	1B.BC250T	138.36		
1-1/2	1	1	531	1D.BC250T	178.03		
2	1	1	873	2.BC250T	220.85		
2-1/2	1	1	1423	2D.BC250T	471.28		

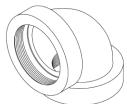
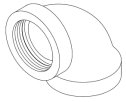

Fig. 31

**CAST IRON  
DRAINAGE SHORT  
TURN 90° ELBOWS**

DESCRIPTION	PCS PER BOX	PCS PER MASTER	WEIGHT PER 100	PART # BLACK	PRICE (US\$) BLACK	PART # GALV.	PRICE (US\$) GALV.
1-1/2	25	25	193	1D.BDL	57.43	1D.NDL	85.11
2	15	15	301	2.BDL	86.50	2.NDL	122.98
3	6	6	750	3.BDL	324.87	3.NDL	486.16
4	2	2	1150	4.BDL	514.51	4.NDL	946.19
2x1-1/2	20	20	275	2X1D.BDL	* 117.50	2X1D.NDL	135.16



**DRAINAGE LONG  
TURN 90° ELBOWS**

Fig. 33

DESCRIPTION	PCS PER BOX	PCS PER MASTER	WEIGHT PER 100	PART # BLACK	PRICE (US\$) BLACK	PART # GALV.	PRICE (US\$) GALV.
1-1/2	15	15	216	1D.BDLTL	80.36	1D.NDLTL	96.78
2	10	10	360	2.BDLTL	119.66	2.NDLTL	166.13
3	5	5	838	3.BDLTL	* 436.44	3.NDLTL	514.05



**DRAINAGE EXTRA  
LONG TURN  
90° ELBOWS**

Fig. 78

DESCRIPTION	PCS PER BOX	PCS PER MASTER	WEIGHT PER 100	PART # BLACK	PRICE (US\$) BLACK	PART # GALV.	PRICE (US\$) GALV.
1-1/2	15	15	324	1D.BDXLTL	103.77	1D.NDXLTL	147.47
2	10	10	415	2.BDXLTL	179.47	2.NDXLTL	236.06



**DRAINAGE SHORT  
TURN 60° ELBOWS**

Fig. 37

DESCRIPTION	PCS PER BOX	PCS PER MASTER	WEIGHT PER 100	PART # BLACK	PRICE (US\$) BLACK	PART # GALV.	PRICE (US\$) GALV.
1-1/2	25	25	182	1D.BD60L	103.95	1D.ND60L	161.28
2	15	15	270	2.BD60L	119.31	2.ND60L	157.82



**DRAINAGE SHORT  
TURN 45° ELBOWS**

Fig. 32

DESCRIPTION	PCS PER BOX	PCS PER MASTER	WEIGHT PER 100	PART # BLACK	PRICE (US\$) BLACK	PART # GALV.	PRICE (US\$) GALV.
1-1/4	25	25	135	1B.BD45L	53.86	1B.ND45L	82.38
1-1/2	25	25	168	1D.BD45L	56.14	1D.ND45L	84.12
2	15	15	257	2.BD45L	81.06	2.ND45L	120.38
3	6	6	694	3.BD45L	317.44	3.ND45L	418.98
4	2	2	1100	4.BD45L	496.20	4.ND45L	684.60

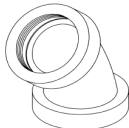

**DRAINAGE LONG  
TURN 45° ELBOWS**

Fig. 34

DESCRIPTION	PCS PER BOX	PCS PER MASTER	WEIGHT PER 100	PART # BLACK	PRICE (US\$) BLACK	PART # GALV.	PRICE (US\$) GALV.
1-1/2	15	15	210	1D.BDLT45L	78.90	1D.NDLT45L	95.75
2	10	10	310	2.BDLT45L	* 134.50	2.NDLT45L	168.93



**DRAINAGE SHORT  
TURN 22-1/2°  
ELBOWS**

Fig. 74

DESCRIPTION	PCS PER BOX	PCS PER MASTER	WEIGHT PER 100	PART # BLACK	PRICE (US\$) BLACK	PART # GALV.	PRICE (US\$) GALV.
1-1/2	25	25	149	1D.BD22L	70.77	1D.ND22L	91.23
2	15	15	260	2.BD22L	94.27	2.ND22L	136.45



**DRAINAGE SHORT  
TURN 11-1/4°  
ELLS**

Fig. 75

DESCRIPTION	PCS PER BOX	PCS PER MASTER	WEIGHT PER 100	PART # BLACK	PRICE (US\$) BLACK	PART # GALV.	PRICE (US\$) GALV.
1-1/2	25	25	149	1D.BD11L	75.31	1D.ND11L	97.55

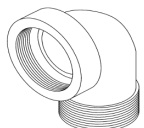

**DRAINAGE STREET  
90° ELBOWS**

Fig. 35

DESCRIPTION	PCS PER BOX	PCS PER MASTER	WEIGHT PER 100	PART # BLACK	PRICE (US\$) BLACK	PART # GALV.	PRICE (US\$) GALV.
1-1/2	25	25	180	1D.BDSTL	81.87	1D.NDSTL	107.79
2	15	15	260	2.BDSTL	108.41	2.NDSTL	168.92

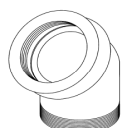

**DRAINAGE STREET  
45° ELBOWS**

Fig. 36

DESCRIPTION	PCS PER BOX	PCS PER MASTER	WEIGHT PER 100	PART # BLACK	PRICE (US\$) BLACK	PART # GALV.	PRICE (US\$) GALV.
1-1/2	25	25	155	1D.BDST45L	76.47	1D.NDST45L	111.54
2	15	15	240	2.BDST45L	123.78	2.NDST45L	171.65



Fig. 38

**DRAINAGE TEES**

DESCRIPTION	PCS PER BOX	PCS PER MASTER	WEIGHT PER 100	PART # BLACK	PRICE (US\$) BLACK	PART # GALV.	PRICE (US\$) GALV.
1-1/2	15	15	270	1D.BDT	94.37	1D.NDT	127.96
2	10	10	425	2.BDT	156.03	2.NDT	214.15
2x1-1/2	10	10	350	2X1D.BDT	* 177.67	2X1D.NDT	241.65



Fig. 39

**DRAINAGE SHORT TURN 90° TYS**

DESCRIPTION	PCS PER BOX	PCS PER MASTER	WEIGHT PER 100	PART # BLACK	PRICE (US\$) BLACK	PART # GALV.	PRICE (US\$) GALV.
1-1/2	15	15	320	1D.BDTY	92.68	1D.NDTY	129.51
2	10	10	488	2.BDTY	152.75	2.NDTY	211.65
4	1	1	2000	4.BDTY	833.35	4.NDTY	1021.68
2 x 1-1/2	10	10	370	2X1D.BDTY	157.05	2X1D.NDTY	242.97
2 x 1-1/2x1-1/2	10	10	350	2X1DX1D.BDTY	157.05	2X1DX1D.NDTY	229.21
2 x 1-1/2x2	10	10	475	2X1DX2.BDTY	157.05	2X1DX2.NDTY	229.21



Fig. 40

**DRAINAGE LONG TURN 90° TYS**

DESCRIPTION	PCS PER BOX	PCS PER MASTER	WEIGHT PER 100	PART # BLACK	PRICE (US\$) BLACK	PART # GALV.	PRICE (US\$) GALV.
1-1/2	10	10	440	1D.BDLTTY	* 154.87	1D.NDLTTY	215.19
2	6	6	700	2.BDLTTY	241.49	2.NDLTTY	390.24
2 x 1-1/2	8	8	500	2X1D.BDLTTY	253.46	2X1D.NDLTTY	390.26
2 x 1-1/2 x 1-1/2			500			2X1DX1D.NDLTTY	416.04
2 x 1-1/2 x 2	8	8	740	2X1DX2.BDLTTY	208.63		



Fig. 41

**DRAINAGE SHORT TURN 45° Y BRANCHES**

DESCRIPTION	PCS PER BOX	PCS PER MASTER	WEIGHT PER 100	PART # BLACK	PRICE (US\$) BLACK	PART # GALV.	PRICE (US\$) GALV.
1-1/2	15	15	360	1D.BDY	113.49	1D.NDY	143.66
2	10	10	509	2.BDY	211.68	2.NDY	288.00
3	1	1	1345	3.BDY		3.NDY	1021.24
4	1	1	2400	4.BDY	1089.37	4.NDY	1566.82
2 x 1-1/2 x 1-1/2	10	10	452	2X1DX1D.BDY	237.91	2X1DX1D.NDY	322.78
2 x 2 x 1-1/2	10	10	450	2X1D.BDY	209.31	2X1D.NDY	254.40
2 x 1-1/2 x 2	10	10	585	2X1DX2.BDY	195.35		
4 x 3	1	1	2000	4X3.BDY	1137.58	4X3.NDY	1600.57



Fig. 42

**DRAINAGE DOUBLE 90° Y BRANCHES**

DESCRIPTION	PCS PER BOX	PCS PER MASTER	WEIGHT PER 100	PART # BLACK	PRICE (US\$) BLACK	PART # GALV.	PRICE (US\$) GALV.
1-1/2	10	10	376	1D.BDDY	221.86	1D.NDDY	275.18
2	8	8	650	2.BDDY	227.42	2.NDDY	321.02
2 x 1-1/2	8	8	513	2X1D.BDDY	233.35	2X1D.NDDY	321.02



Fig. 45

**DRAINAGE P TRAP WITH CLEANOUT**

DESCRIPTION	PCS PER BOX	PCS PER MASTER	WEIGHT PER 100	PART # BLACK	PRICE (US\$) BLACK	PART # GALV.	PRICE (US\$) GALV.
1-1/2	10	10	469	1D.BDPT	168.64	1D.NDPT	232.32
2	8	8	600	2.BDPT	269.99	2.NDPT	406.65

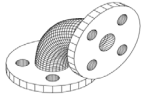

Fig. 46

**P TRAP WITHOUT DRAIN**

DESCRIPTION	PCS PER BOX	PCS PER MASTER	WEIGHT PER 100	PART # BLACK	PRICE (US\$) BLACK	PART # GALV.	PRICE (US\$) GALV.
1-1/2	10	10	380	1D.BDPTWO	173.50	1D.NDPTWO	228.31
2	8	8	647	2.BDPTWO	277.72	2.NDPTWO	399.67





**FLANGED 90° ELLS**

DESCRIPTION	PCS PER BOX	PCS PER MASTER	WEIGHT PER 100	PART # BLACK	PRICE (US\$) BLACK	PART # GALV.	PRICE (US\$) GALV.
2	1	1	1300	2.BFL	502.84	2.NFL	1043.47
2-1/2	1	1	1900	2D.BFL	543.92	2D.NFL	1427.42
3	1	1	2700	3.BFL	453.99	3.NFL	1407.12
4	1	1	4000	4.BFL	561.45	4.NFL	1282.83
5	1	1	5700	5.BFL	1329.73	5.NFL	2703.83
6	1	1	7000	6.BFL	879.07	6.NFL	2065.39
8	1	1	11600	8.BFL	1517.91	8.NFL	3217.11
10	1	1	17700	10.BFL	3326.77	10.NFL	5953.24
12	1	1	24800	12.BFL	6696.98	12.NFL	9933.93
3X2	1	1	2100	3X2.BFL	1541.81	3X2.NFL	1824.79
3X2-1/2	1	1	2300	3X2D.BFL	1681.94	3X2D.NFL	2065.84
4X2	1	1	3200	4X2.BFL	1903.69	4X2.NFL	2253.15
4X2-1/2	1	1	3500	4X2D.BFL	1903.69	4X2D.NFL	2253.15
4X3	1	1	3500	4X3.BFL	1245.55	4X3.NFL	1939.67
5X4	1	1	6500	5X4.BFL	2532.93		
6X3	1	1	5900	6X3.BFL	2743.42	6X3.NFL	3705.16
6X4	1	1	6700	6X4.BFL	1544.61	6X4.NFL	3129.47
6X5	1	1	6600	6X5.BFL	2624.13	6X5.NFL	3106.19
8X4	1	1	8900	8X4.BFL	3039.01	8X4.NFL	5272.56
8X6	1	1	9200	8X6.BFL	2253.62	8X6.NFL	4444.12
8X5	1	1	9200	8X5.BFL	4014.64	8X5.NFL	5422.08
10X6	1	1	15500	10X6.BFL	6268.11	10X6.NFL	8465.17
10X8	1	1	16000	10X8.BFL	4291.03	10X8.NFL	8231.84
12X6	1	1	23400	12X6.BFL	11903.25		
12X8	1	1	23400	12X8.BFL	10866.31	12X8.NFL	14675.16
12X10	1	1	23700	12X10.BFL	8222.94	12X10.NFL	14275.03

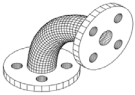

**FLANGED LONG RADIUS 90° ELLS**

DESCRIPTION	PCS PER BOX	PCS PER MASTER	WEIGHT PER 100	PART # BLACK	PRICE (US\$) BLACK	PART # GALV.	PRICE (US\$) GALV.
2	1	1	1500	2.BFLL	1354.11	2.NFLL	1749.22
3	1	1	2800	3.BFLL	1462.78	3.NFLL	2478.12
4	1	1	4700	4.BFLL	1341.50	4.NFLL	3511.00
6	1	1	9200	6.BFLL	1940.43	6.NFLL	3730.44
8	1	1	13400	8.BFLL	3729.73	8.NFLL	6489.72
10	1	1	21600	10.BFLL	5806.11	10.NFLL	10080.40
12	1	1	35600	12.BFLL	11963.71	12.NFLL	19850.41



**FLANGED LONG RADIUS 90° REDUCING ELLS**

DESCRIPTION	PCS PER BOX	PCS PER MASTER	WEIGHT PER 100	PART # BLACK	PRICE (US\$) BLACK	PART # GALV.	PRICE (US\$) GALV.
4X3	1	1	4200	4X3.BFLL	3193.13	4X3.NFLL	3730.65
6X4	1	1	8100	6X4.BFLL	4167.79	6X4.NFLL	5628.67
8X6	1	1	13000	8X6.BFLL	7703.86	8X6.NFLL	9990.20

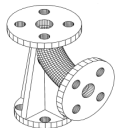

**FLANGED 90° BASE ELLS**

DESCRIPTION	PCS PER BOX	PCS PER MASTER	WEIGHT PER 100	PART # BLACK	PRICE (US\$) BLACK	PART # GALV.	PRICE (US\$) GALV.
4	1	1	5200	4.BFBL	2181.64	4.NFBL	2946.25
6	1	1	8800	6.BFBL	3717.00	6.NFBL	5019.97
8	1	1	15300	8.BFBL	4925.96	8.NFBL	6649.78
10	1	1	22700	10.BFBL	8270.78	10.NFBL	10684.31
12	1	1	34000	12.BFBL	11390.11		

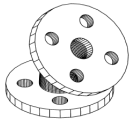

**FLANGED 45° ELLS**

DESCRIPTION	PCS PER BOX	PCS PER MASTER	WEIGHT PER 100	PART # BLACK	PRICE (US\$) BLACK	PART # GALV.	PRICE (US\$) GALV.
2	1	1	1100	2.BF45L	728.60	2.NF45L	1345.27
2-1/2	1	1	1900	2D.BF45L	777.13	2D.NF45L	1327.63
3	1	1	2100	3.BF45L	755.72	3.NF45L	1492.84
4	1	1	3700	4.BF45L	850.60	4.NF45L	1852.18
5	1	1	3700	5.BF45L	2038.20	5.NF45L	3347.48
6	1	1	6000	6.BF45L	1390.60	6.NF45L	2583.70
8	1	1	9600	8.BF45L	2033.51	8.NF45L	3875.15
10	1	1	14700	10.BF45L	4296.91	10.NF45L	7416.60
12	1	1	21200	12.BF45L	6565.66	12.NF45L	11328.12

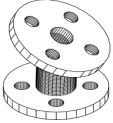

**FLANGED 22-1/2° ELLS**

DESCRIPTION	PCS PER BOX	PCS PER MASTER	WEIGHT PER 100	PART # BLACK	PRICE (US\$) BLACK	PART # GALV.	PRICE (US\$) GALV.
4	1	1	3530	4.BF22L	954.72	4.NF22L	1832.36
6	1	1	5730	6.BF22L	1378.51	6.NF22L	2646.69
8	1	1	9230	8.BF22L	2068.13	8.NF22L	3970.41
12	1	1	21610	12.BF22L	6495.90	12.NF22L	10742.08

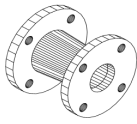

**FLANGED CONCENTRIC REDUCERS**

DESCRIPTION	PCS PER BOX	PCS PER MASTER	WEIGHT PER 100	PART # BLACK	PRICE (US\$) BLACK	PART # GALV.	PRICE (US\$) GALV.
2-1/2X2	1	1	1400	2DX2.BFCRD	1269.10	2DX2.NFCRD	2012.18
3X2	1	1	1700	3X2.BFCRD	1007.50	3X2.NFCRD	1721.55
3X2-1/2	1	1	2000	3X2D.BFCRD	1007.50	3X2D.NFCRD	1652.15
4X2	1	1	2400	4X2.BFCRD	1345.80	4X2.NFCRD	2385.59
4X2-1/2	1	1	2700	4X2D.BFCRD	1217.66	4X2D.NFCRD	2385.59
4X3	1	1	2900	4X3.BFCRD	1132.01	4X3.NFCRD	2009.45
5X3	1	1	4100	5X3.BFCRD	1991.03	5X3.NFCRD	3509.32
5X4	1	1	4000	5X4.BFCRD	1750.39	5X4.NFCRD	3113.46
6X2	1	1	3900	6X2.BFCRD	3044.21	6X2.NFCRD	5056.04
6X2-1/2	1	1	3900	6X2D.BFCRD	2302.38	6X2D.NFCRD	3976.11
6X3	1	1	4200	6X3.BFCRD	1745.18	6X3.NFCRD	3441.70
6X4	1	1	5000	6X4.BFCRD	1516.00	6X4.NFCRD	2927.75
6X5	1	1	5200	6X5.BFCRD	1665.29	6X5.NFCRD	3377.00
8X4	1	1	7400	8X4.BFCRD	2197.88	8X4.NFCRD	4427.16
8X5	1	1	7500	8X5.BFCRD	3454.82	8X5.NFCRD	4736.19
8X6	1	1	8000	8X6.BFCRD	1907.95	8X6.NFCRD	3389.69
10X6	1	1	10800	10X6.BFCRD	4285.69	10X6.NFCRD	8620.28
10X8	1	1	12000	10X8.BFCRD	3934.77	10X8.NFCRD	7758.19
12X6	1	1	15300	12X6.BFCRD	7843.16	12X6.NFCRD	13618.89
12X8	1	1	15800	12X8.BFCRD	7501.38	12X8.NFCRD	13026.51
12X10	1	1	19500	12X10.BFCRD	6786.86	12X10.NFCRD	13026.51

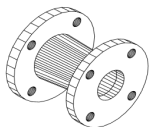

**FLANGED ECCENTRIC REDUCERS**

DESCRIPTION	PCS PER BOX	PCS PER MASTER	WEIGHT PER 100	PART # BLACK	PRICE (US\$) BLACK	PART # GALV.	PRICE (US\$) GALV.
3X2	1	1	1700	3X2.BFERD	1519.80	3X2.NFERD	2052.51
3x2-1/2	1	1	1600	3X2D.BFERD	1541.81	3X2D.NFERD	2053.77
4X2	1	1	2500	4X2.BFERD	2123.07	4X2.NFERD	2742.52
4X2-1/2	1	1	2500	4X2D.BFERD	2138.31		
4X3	1	1	2800	4X3.BFERD	1837.33	4X3.NFERD	2742.52
6X3	1	1	4400	6X3.BFERD	2896.78	6X3.NFERD	3911.93
6X4	1	1	4900	6X4.BFERD	1735.43	6X4.NFERD	3260.91
6X5	1	1	5500	6X5.BFERD	1735.43	6X5.NFERD	3423.50
8X4	1	1	7300	8X4.BFERD	2981.13	8X4.NFERD	4951.29
8X5	1	1	7500	8X5.BFERD	2851.57	8X5.NFERD	4951.29
8X6	1	1	8400	8X6.BFERD	2198.32	8X6.NFERD	4127.16
10X6	1	1	11200	10X6.BFERD	6567.93	10X6.NFERD	8870.18
10X8	1	1	12500	10X8.BFERD	5599.68	10X8.NFERD	8484.59
12X8	1	1	16700	12X8.BFERD	7861.47	12X8.NFERD	13650.53
12X10	1	1	18500	12X10.BFERD	7590.36	12X10.NFERD	11609.33



**STANDARD FLANGED TEES**

DESCRIPTION	PCS PER BOX	PCS PER MASTER	WEIGHT PER 100	PART # BLACK	PRICE (US\$) BLACK	PART # GALV.	PRICE (US\$) GALV.
2	1	1	1700	2.BFT	550.57	2.NFT	984.54
2-1/2	1	1	2700	2D.BFT	801.90	2D.NFT	1329.35
3	1	1	4400	3.BFT	562.00	3.NFT	1334.73
4	1	1	6400	4.BFT	854.88	4.NFT	2113.05
5	1	1	8300	5.BFT	2290.10	5.NFT	3138.03
6	1	1	10500	6.BFT	1240.58	6.NFT	2905.33
8	1	1	16300	8.BFT	2119.48	8.NFT	4580.49
10	1	1	26000	10.BFT	5702.95	10.NFT	8693.78
12	1	1	40200	12.BFT	8958.75	12.NFT	13280.86

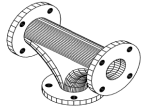

**REDUCING FLANGED TEES**

DESCRIPTION	PCS PER BOX	PCS PER MASTER	WEIGHT PER 100	PART # BLACK	PRICE (US\$) BLACK	PART # GALV.	PRICE (US\$) GALV.
3X3X2-1/2	1	1	3800	3X2D.BFT	1668.33	3X2D.NFT	2275.52
3 X3X2	1	1	3400	3X2.BFT	1305.95	3X2.NFT	2267.98
4X4X6	1	1	8300	4X6.BFT	3397.96	4X6.NFT	4462.57
4x3X4	1	1	5500	4X3X4.BFT	4207.84		
4X4X2	1	1	5400	4X2.BFT	1759.60	4X2.NFT	2926.87
4 X 4X 2-1/2	1	1	5500	4X2D.BFT	1921.63	4X2D.NFT	3193.93
4 X4X3	1	1	5900	4X3.BFT	1759.60	4X3.NFT	3052.94
6X4X3	1	1	8600	6X4X3.BFT	711.82		
6X4X4	1	1	9000	6X4X4.BFT	2157.21	6X4X4.NFT	3826.83
6X4X6	1	1	9500	6X4X6.BFT	1951.70	6X4X6.NFT	3850.25
6X6X2	1	1	8700	6X2.BFT	3462.00	6X2.NFT	4470.73
6X6X2-1/2	1	1	8800	6X2D.BFT	3297.11	6X2D.NFT	4262.50
6X6X3	1	1	9700	6X3.BFT	2464.25	6X3.NFT	4277.93
6X6X4	1	1	9600	6X4.BFT	1693.94	6X4.NFT	3295.33
6X6X8	1	1	13800	6X8.BFT	4201.91	6X8.NFT	7297.38
8X4X8	1	1	13800	8X4X8.BFT	5664.36		
8X6X4	1	1	12700	8X6X4.BFT	5391.49	8X6X4.NFT	6826.94
8X6X6	1	1	13900	8X6X6.BFT	3180.34	8X6X6.NFT	6269.30
8X6X8	1	1	14900	8X6X8.BFT	4201.91	8X6X8.NFT	7549.49
8X8X4	1	1	14400	8X4.BFT	3179.83	8X4.NFT	5971.53
8X8X6	1	1	15500	8X6.BFT	2646.23	8X6.NFT	5858.16
10X8X8	1	1	23600	10X8X8.BFT	6685.91	10X8X8.NFT	11360.94
10X8X10	1	1	24900	10X8X10.BFT	9654.50		
10X10X4	1	1	22000	10X4.BFT	6870.34	10X4.NFT	11410.39
10X10X6	1	1	22900	10X6.BFT	7035.15	10X6.NFT	11369.31
10X10X8	1	1	24900	10X8.BFT	6049.23	10X8.NFT	11360.94
10X10X12	1	1	34200	10X12.BFT	10372.31	10X12.NFT	18215.24
12X10X10	1	1	34200	12X10X10.BFT	3414.06		
12X12X4	1	1	34100	12X4.BFT	9948.17		
12X12X6	1	1	35700	12X6.BFT	8977.03	12X6.NFT	17228.21
12X12X8	1	1	36700	12X8.BFT	10621.70	12X8.NFT	17228.21
12X12X10	1	1	36700	12X10.BFT	10470.46	12X10.NFT	17228.21

**FLANGED BASE TEES**

DESCRIPTION	PCS PER BOX	PCS PER MASTER	WEIGHT PER 100	PART # BLACK	PRICE (US\$) BLACK	PART # GALV.	PRICE (US\$) GALV.
3	1	1	4700	3.BFBT	1352.43		
4	1	1	7200	4.BFBT	1640.65		
6	1	1	12200	6.BFBT	2853.17		
8	1	1	21100	8.BFBT	8545.69		
10	1	1	30000	10.BFBT	7645.41		
12	1	1	43000	12.BFBT	11035.64		



**FLANGED CROSSES**

DESCRIPTION	PCS PER BOX	PCS PER MASTER	WEIGHT PER 100	PART # BLACK	PRICE (US\$) BLACK	PART # GALV.	PRICE (US\$) GALV.
2	1	1	3000	2.BFCR	1803.77		
2-1/2	1	1	4100	2D.BFCR	1597.89	2D.NFCR	2878.05
3	1	1	5000	3.BFCR	1677.82	3.NFCR	2781.97
4	1	1	8200	4.BFCR	2191.59	4.NFCR	3803.98
6	1	1	13400	6.BFCR	4589.84	6.NFCR	6199.07
8	1	1	21300	8.BFCR	7392.21	8.NFCR	9548.10
10	1	1	33000	10.BFCR	8769.22	10.NFCR	15502.75
12	1	1	46000	12.BFCR	13377.44	12.NFCR	23495.65



**FLANGED REDUCING CROSSES**

DESCRIPTION	PCS PER BOX	PCS PER MASTER	WEIGHT PER 100	PART # BLACK	PRICE (US\$) BLACK	PART # GALV.	PRICE (US\$) GALV.
6X4	1	1	11900	6X4.BFCR	3101.15	6X4.NFCR	5062.72
8X6	1	1	18400	8X6.BFCR	4795.25	8X6.NFCR	7826.15

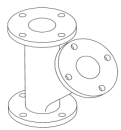

**FLANGED LATERAL**

DESCRIPTION	PCS PER BOX	PCS PER MASTER	WEIGHT PER 100	PART # BLACK	PRICE (US\$) BLACK	PART # GALV.	PRICE (US\$) GALV.
2-1/2	1	1	3400	2D.BFLAT	2247.87	2D.NFLAT	3308.08
3	1	1	4500	3.BFLAT	2404.56	3.NFLAT	3197.45
4	1	1	7700	4.BFLAT	3138.90	4.NFLAT	4239.31
6	1	1	13000	6.BFLAT	4775.34	6.NFLAT	7235.71
8	1	1	21300	8.BFLAT	7824.74	8.NFLAT	10726.07
10	1	1	33500	10.BFLAT	10101.90	10.NFLAT	17732.96
12	1	1	51500	12.BFLAT	15561.11		

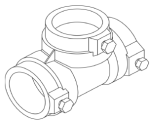

**WARDLOX TEES SLIP X SLIP X SLIP**

DESCRIPTION	PCS PER BOX	PCS PER MASTER	WEIGHT PER 100	PART # BLACK	PRICE (US\$) BLACK	PART # GALV.	PRICE (US\$) GALV.
1X1X1	12	12	289	1.BWST	94.44	1.NWST	112.07
1-1/4 X 1-1/4 X 1-1/4	12	12	366	1B.BWST	94.44	1B.NWST	114.27
1-1/2 X 1-1/2 X 1-1/2	12	12	388	1D.BWST	95.94	1D.NWST	124.98
2 X 2 X 2	4	4	641	2.BWST	131.77	2.NWST	168.70

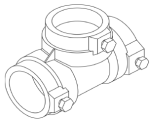

**WARDLOX REDUCING OUTLET TEES SLIP X SLIP X SLIP**

DESCRIPTION	PCS PER BOX	PCS PER MASTER	WEIGHT PER 100	PART # BLACK	PRICE (US\$) BLACK	PART # GALV.	PRICE (US\$) GALV.
2X2X1	8	8	467	2X1.BWST	115.43	2X1.NWST	143.03
2X2X1-1/4	5	5	529	2X1B.BWST	115.43	2X1B.NWST	143.03
2X2X1-1/2	5	5	593	2X1D.BWST	115.43	2X1D.NWST	143.03

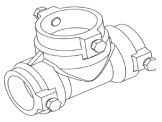

**WARDLOX BULLHEAD TEES SLIP X SLIP X SLIP**

DESCRIPTION	PCS PER BOX	PCS PER MASTER	WEIGHT PER 100	PART # BLACK	PRICE (US\$) BLACK	PART # GALV.	PRICE (US\$) GALV.
1-1/2 X 1-1/2 X 2	5	5	535	1DX2.BWST	115.43	1DX2.NWST	143.03

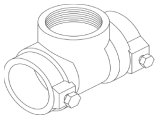

**WARDLOX REDUCING OUTLET TEES SLIP X SLIP X THREAD**

DESCRIPTION	PCS PER BOX	PCS PER MASTER	WEIGHT PER 100	PART # BLACK	PRICE (US\$) BLACK	PART # GALV.	PRICE (US\$) GALV.
1X1X1/2	20	20	200	1XD.BWT	64.73	1XD.NWT	79.84
1X1X3/4	20	20	196	1XE.BWT	64.73	1XE.NWT	84.63
1X1X1	20	20	174	1.BWT	64.73	1.NWT	84.63
1-1/4X1-1/4X1/2	15	15	249	1BXD.BWT	64.73	1BXD.NWT	84.63
1-1/4X1-1/4X3/4	15	15	256	1BXE.BWT	64.73	1BXE.NWT	79.84
1-1/4X1-1/4X1	15	15	240	1BX1.BWT	64.73	1BX1.NWT	84.63
1-1/2X1-1/2X1/2	15	15	298	1DXD.BWT	68.56	1DXD.NWT	85.30
1-1/2X1-1/2X3/4	10	10	292	1DXE.BWT	68.56	1DXE.NWT	90.42
1-1/2X1-1/2X1	10	10	285	1DX1.BWT	68.56	1DX1.NWT	74.24
2X2X1/2	9	9	402	2XD.BWT	83.94	2XD.NWT	104.73
2X2X3/4	9	9	393	2XE.BWT	83.94	2XE.NWT	111.01
2X2X1	9	9	366	2X1.BWT	83.94	2X1.NWT	111.01

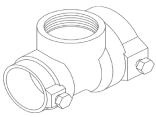

**WARDLOX REDUCING RUN & OUTLET TEES SLIP X SLIP X THREAD**

DESCRIPTION	PCS PER BOX	PCS PER MASTER	WEIGHT PER 100	PART # BLACK	PRICE (US\$) BLACK	PART # GALV.	PRICE (US\$) GALV.
1-1/4X1X1/2	15	15	233	1BX1XD.BWT	69.24	1BX1XD.NWT	85.30
1-1/4X1X3/4	15	15	240	1BX1XE.BWT	56.84		
1-1/4X1X1	15	15	236	1BX1X1.BWT	69.24	1BX1X1.NWT	80.28
1-1/2X1-1/4X1/2	10	10	276	1DX1BXD.BWT	73.46	1DX1BXD.NWT	96.29
1-1/2X1-1/4X3/4	10	10	288	1DX1BXE.BWT	73.46	1DX1BXE.NWT	96.29
1-1/2X1-1/4X1	10	10	272	1DX1BX1.BWT	73.46	1DX1BX1.NWT	79.08
2X1-1/2X1/2	9	9	381	2X1DXD.BWT	88.85	2X1DXD.NWT	110.18
2X1-1/2X3/4	9	9	372	2X1DXE.BWT	88.85	2X1DXE.NWT	110.18
2X1-1/2X1	9	9	360	2X1DX1.BWT	88.85	2X1DX1.NWT	116.78



**WARDLOX 90° ELBOWS SLIP X SLIP**

DESCRIPTION	PCS PER BOX	PCS PER MASTER	WEIGHT PER 100	PART # BLACK	PRICE (US\$) BLACK	PART # GALV.	PRICE (US\$) GALV.
1	20	20	206	1.BWL	69.10	1.NWL	74.24
1-1/4	15	15	253	1B.BWL	80.80	1B.NWL	84.64
1-1/2	10	10	290	1D.BWL	88.56	1D.NWL	114.32
2	6	6	415	2.BWL	104.65	2.NWL	135.81



**WARDLOX ADAPTER  
ELBOWS SLIP X  
THREAD**

DESCRIPTION	PCS PER BOX	PCS PER MASTER	WEIGHT PER 100	PART # BLACK	PRICE (US\$) BLACK	PART # GALV.	PRICE (US\$) GALV.
1X1/2	25	25	150	1XD.BWL	82.46	1XD.NWL	107.97
1X3/4	25	25	138	1XE.BWL	82.46	1XE.NWL	107.97
1X1	25	25	160	1X1.BWL	82.46	1X1.NWL	107.97
1-1/4X1/2	15	15	207	1BXD.BWL	85.31	1BXD.NWL	114.91
1-1/4X3/4	15	15	199	1BXE.BWL	85.31	1BXE.NWL	108.41
1-1/4X1	15	15	188	1BX1.BWL	85.31	1BX1.NWL	108.41
1-1/2X1/2	10	10	248	1DXD.BWL	87.78	1DXD.NWL	121.39
1-1/2X3/4	10	10	236	1DXE.BWL	87.78	1DXE.NWL	121.39
1-1/2 X1	10	10	238	1DX1.BWL	87.78	1DX1.NWL	121.39
2X1/2	9	9	302	2XD.BWL	90.49	2XD.NWL	126.56
2X3/4	9	9	323	2XE.BWL	90.49	2XE.NWL	119.42
2X1	9	9	288	2X1.BWL	90.49	2X1.NWL	126.56

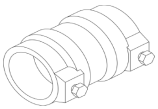

**WARDLOX  
COUPLINGS  
SLIP X SLIP**

DESCRIPTION	PCS PER BOX	PCS PER MASTER	WEIGHT PER 100	PART # BLACK	PRICE (US\$) BLACK	PART # GALV.	PRICE (US\$) GALV.
1X1	25	25	154	1.BWC	61.87	1.NWC	80.57
1-1/4X1-1/4	15	15	227	1B.BWC	61.87	1B.NWC	66.15
1-1/2X1-1/2	15	15	261	1D.BWC	77.80	1D.NWC	79.54
2X2	10	10	360	2.BWC	77.80	2.NWC	105.10

**WARDLOX  
GASKETS  
SLIP X SLIP**

DESCRIPTION	PCS PER BOX	PCS PER MASTER	WEIGHT PER 100	PART # BLACK	PRICE (US\$) BLACK	PART # GALV.	PRICE (US\$) GALV.
1	25	25	2.9			1.WG	17.74
1-1/4	25	25	3			1B.WG	20.77
1-1/2	25	25	3.1			1D.WG	24.67
2	1	1	3.2			2.WG	26.08

**WARDLOX BOLT/  
SOCKETS**

DESCRIPTION	PCS PER BOX	PCS PER MASTER	WEIGHT PER 100	PART # BLACK	PRICE (US\$) BLACK	PART # GALV.	PRICE (US\$) GALV.
3/8 Square Head	1500	1500	4	WB	7.36		

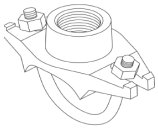

**TEELOX MECHANICAL BRANCH CONNECTOR**

DESCRIPTION	PCS PER BOX	PCS PER MASTER	WEIGHT PER 100	PART # BLACK	PRICE (US\$) BLACK	PART # GALV.	PRICE (US\$) GALV.
1-1/4X1/2	25	25	98	1BXD.BTLX	15.06	1BXD.NTLX	28.72
1-1/4X3/4	25	25	99	1BXE.BTLX	15.06	1BXE.NTLX	28.72
1-1/4X1	25	25	108	1BX1.BTLX	18.79	1BX1.NTLX	30.27
1-1/2X1/2	25	25	98	1DXD.BTLX	15.06	1DXD.NTLX	30.27
1-1/2X3/4	25	25	99	1DXE.BTLX	15.06	1DXE.NTLX	30.27
1-1/2X1	25	25	108	1DX1.BTLX	18.79	1DX1.NTLX	30.27
2X1/2	25	25	96	2XD.BTLX	15.06	2XD.NTLX	30.27
2X3/4	25	25	85	2XE.BTLX	15.06	2XE.NTLX	30.27
2X1	25	25	99	2X1.BTLX	18.79	2X1.NTLX	31.61
2-1/2X1/2	25	25	121	2DXD.BTLX	15.06	2DXD.NTLX	35.31
2-1/2X3/4	25	25	120	2DXE.BTLX	15.06	2DXE.NTLX	35.31
2-1/2X1	25	25	111	2DX1.BTLX	18.79	2DX1.NTLX	57.53

**SPECIFICATIONS**

DESCRIPTION	A	B	C
1-1/4X1/2	2	1-1/2	1-3/16
1-1/4X3/4	2-1/16	1-1/2	1-3/16
1-1/4X1	2-1/8	1-1/2	1-3/16
1-1/2X1/2	2	1-1/2	1-3/16
1-1/2X3/4	2-1/16	1-1/2	1-3/16
1-1/2X1	2-1/8	1-1/2	1-3/16
2X1/2	2-5/16	1-13/16	1-3/16
2X3/4	2-3/8	1-13/16	1-3/16
2X1	2-7/16	1-13/16	1-3/16
2-1/2X1/2	2-9/16	2-1/16	1-3/16
2-1/2X3/4	2-11/16	2-1/8	1-3/16
2-1/2X1	2-3/4	2-1/8	1-3/16

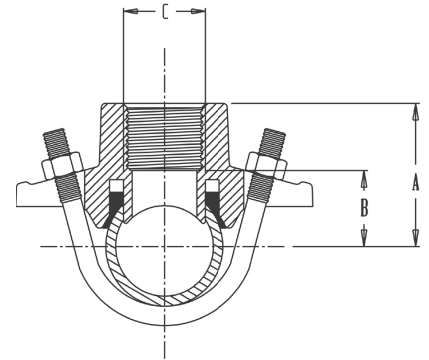

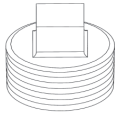

**STEEL SQUARE HEAD PLUGS**

DESCRIPTION	PCS PER BOX	PCS PER MASTER	WEIGHT PER 100	PART # BLACK	PRICE (US\$) BLACK	PART # GALV.	PRICE (US\$) GALV.
1/8	100	600	2	A.BSP	* 0.66	A.NSP	* 0.67
1/4	100	600	4	B.BSP	* 0.86	B.NSP	* 0.93
3/8	75	450	6	C.BSP	* 1.19	C.NSP	* 1.23
1/2	50	300	12	D.BSP	* 1.98	D.NSP	* 2.24
3/4	50	200	18	E.BSP	* 2.81	E.NSP	* 3.21

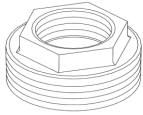

**STEEL HEXAGON BUSHINGS**

DESCRIPTION	PCS PER BOX	PCS PER MASTER	WEIGHT PER 100	PART # BLACK	PRICE (US\$) BLACK	PART # GALV.	PRICE (US\$) GALV.
1/4 X 1/8	25	150	2	BXA.BSB	* 1.82	BXA.NSB	1.89
3/8 X 1/8	25	150	5	CXA.BSB	* 2.15	CXA.NSB	* 2.33
3/8 X 1/4	25	150	4	CXB.BSB	* 2.15	CXB.NSB	2.33
1/2 X 1/8	25	150	8	DXA.BSB	* 3.86	DXA.NSB	3.74
1/2 x 1/4	25	150	7	DXB.BSB	* 3.36	DXB.NSB	* 3.74
1/2 x 3/8	25	150	6	DXC.BSB	* 3.36	DXC.NSB	* 3.74
3/4 x 1/8	50	200	20	EXA.BSB	* 5.23	EXA.NSB	* 5.86
3/4 x 1/4	50	200	16	EXB.BSB	* 5.23	EXB.NSB	* 5.86
3/4 x 3/8	50	200	14	EXC.BSB	* 5.23	EXC.NSB	* 5.86
3/4 x 1/2	50	200	10	EXD.BSB	* 5.23	EXD.NSB	* 5.86
1 x 1/8	25	100	35	1XA.BSB	* 5.69	1XA.NSB	* 6.18
1 x 1/4	25	100	31	1XB.BSB	* 5.69	1XB.NSB	* 6.55
1 x 3/8	25	100	30	1XC.BSB	* 5.69	1XC.NSB	* 6.55
1 x 1/2	25	100	25	1XD.BSB	* 5.69	1XD.NSB	* 6.55
1 x 3/4	25	100	15	1XE.BSB	* 5.69	1XE.NSB	* 6.55

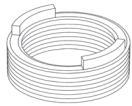

**STEEL FLUSH BUSHINGS**

DESCRIPTION	PCS PER BOX	PCS PER MASTER	WEIGHT PER 100	PART # BLACK	PRICE (US\$) BLACK	PART # GALV.	PRICE (US\$) GALV.
1/4 X 1/8	25	150	1	BXA.BFB	1.93	BXA.NFB	2.01
3/8 X 1/4	25	150	1	CXB.BFB	2.24	CXB.NFB	2.53
1/2 x 1/8	25	150	5	DXA.BFB	4.82		
1/2 x 1/4	25	150	3	DXB.BFB	5.12	DXB.NFB	6.14
1/2 x 3/8	25	150	2	DXC.BFB	5.12	DXC.NFB	6.14
3/4 x 1/4	25	150	8	EXB.BFB	7.17	EXB.NFB	8.60
3/4 x 3/8	25	150	7	EXC.BFB	7.17	EXC.NFB	8.60
3/4 x 1/2	25	150	5	EXD.BFB	* 7.17	EXD.NFB	* 8.60

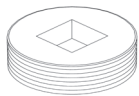

**STEEL HEX SOCKET PLUGS**

DESCRIPTION	PCS PER BOX	PCS PER MASTER	WEIGHT PER 100	PART # BLACK	PRICE (US\$) BLACK	PART # GALV.	PRICE (US\$) GALV.
1/8	100	600	1	A.BSHSP	* 0.66	A.NSHSP	* 0.67
1/4	100	600	2	B.BSHSP	* 0.86	B.NSHSP	* 0.88
3/8	100	600	3	C.BSHSP	* 1.19	C.NSHSP	* 1.23
1/2	100	600	7	D.BSHSP	* 1.98	D.NSHSP	* 2.11
3/8	300	300	10	E.BSHSP	* 2.65	E.NSHSP	* 3.03



**STEEL SQUARE HEAD COUNTERSUNK PLUGS**

DESCRIPTION	PCS PER BOX	PCS PER MASTER	WEIGHT PER 100	PART # BLACK	PRICE (US\$) BLACK	PART # GALV.	PRICE (US\$) GALV.
1/4	100	600	2	B.BCTP	* 0.86	B.NCTP	* 0.93
3/8	75	450	2	C.BCTP	1.19	C.NCTP	1.23



**STEEL CAPS**

DESCRIPTION	PCS PER BOX	PCS PER MASTER	WEIGHT PER 100	PART # BLACK	PRICE (US\$) BLACK	PART # GALV.	PRICE (US\$) GALV.
1/8	50	300	3	A.BSCAP	* 1.62	A.NSCAP	* 1.71
1/4	40	240	7	B.BSCAP	* 2.11	B.NSCAP	* 2.26
3/8	40	240	9	C.BSCAP	* 3.13	C.NSCAP	* 3.41
1/2	50	200	12	D.BSCAP	* 4.91	D.NSCAP	* 4.91
3/4	25	150	16	E.BSCAP	* 10.36	E.NSCAP	* 11.45

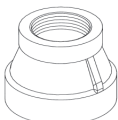

**STEEL REDUCING COUPLINGS**

DESCRIPTION	PCS PER BOX	PCS PER MASTER	WEIGHT PER 100	PART # BLACK	PRICE (US\$) BLACK	PART # GALV.	PRICE (US\$) GALV.
1/4 x 1/8	25	150	9	BXA.BSC	* 9.17	BXA.NSC	* 11.50